

# Infrico



Válido para todo el catálogo:

Precios válidos salvo error tipográfico o cambio de tarifa /

Etiqueta energética disponible en las fichas técnicas de producto en nuestra web [infrico.com](http://infrico.com) /

Fotografías no contractuales /

Características técnicas y constructivas sujetas a variación sin previo aviso /

Los datos técnicos están sujetos a posibles variaciones que serán actualizadas periódicamente en las fichas técnicas del producto, disponibles en la web.

Valid for the entire product guide:

Prices valid except in the case of typographical error or change of price list /

Energy label available in the product data sheets on our website [infrico.com](http://infrico.com) /

Non contractual pictures /

We reserve the right to change specifications without prior notice /

The technical data are subject to possible variations that will be updated periodically in the technical data sheets of the product, which are available on the website.

Valable pour tout le catalogue:

Prix valables sauf en cas d'erreur typographique ou de changement de tarif.

Étiquette énergétique disponible dans les fiches produits sur notre site [infrico.com](http://infrico.com) /

Photos non contractuelles /

Les caractéristiques techniques et la conception peuvent être sujettes à modifications, sans préavis /

Les données techniques peuvent varier et seront actualisées dans les fiches techniques du produit, disponibles sur le site web.

**Infrico S. L. 2024**

# GRUPO Infrico®



**INFRICO** nace en 1986 con un objetivo claro: generar las mejores soluciones de refrigeración adaptadas a las necesidades específicas de cada cliente. **Vanguardia tecnológica, calidad certificada y la excelencia de sus productos son las garantías** que avalan su compromiso de innovación y que la han posicionado como líderes absolutos en el sector del equipamiento del frío comercial.

La empresa ofrece una muy amplia gama de maquinaria que abarca todo lo relacionado con el frío para el sector **HORECA**, panadería, pastelería, heladería, catering y también **Supermarket**, mediante su línea específica,

**INFRICO** was born in 1986 with a clear objective: to generate the best cooling solutions adapted to the specific needs of each client. **Technological vanguard, certified quality and the excellence of its products are the guarantees** to support its commitment to innovation and that have positioned it as absolute leaders in the commercial refrigeration equipment. The company offers a very wide range of machinery that covers everything related to cold for the **HORECA** sector, bakery, pastry, ice cream, catering and also **Supermarket**, through its specific line, thanks to cold. Also,

**INFRICO** est un fabricant espagnol leader dans la production d'équipement de réfrigération commerciale. **Technologie de pointe et qualité certifiée sont les garanties** sur lesquelles est fondé notre engagement d'innovation: élaborer les meilleures idées et solutions pour chacun de nos clients.

a través del frío. También el sector biomédico y de laboratorio con su prestigiosa línea **Infrico Medicare**.

Con clientes en todo el mundo y una gran cuota de mercado nacional, la compañía, que se encuentra en un continuo proceso de crecimiento y expansión, cuenta en la actualidad con más de quinientos empleados repartidos en 13 delegaciones en España y 16 en el extranjero. Además, en una firme apuesta por la estabilidad y el bienestar social, más del 90% de los trabajadores son empleados fijos.

**Infrico** posee el Certificado de **Origen Español Certificado** (O.E.C.) que acredita

the biomedical and laboratory sector, with its prestigious **Infrico Medicare** line.

It has customers around the world and a large share of the national market, the company, which is in a continuous process of growth and expansion, currently has more than five hundred employees spread across 13 delegations in Spain and 16 abroad. In addition, in a firm commitment to stability and social welfare, more than 90% of workers are permanent employees.

The company has **Spanish Origin Certificate** (S.O.C.) that certifies that its products are man-

L'entreprise se situe parmi les entreprises leaders du secteur, avec une position très avantageuse par rapport à ses concurrents quant au volume de marché et à sa présence sur le territoire français.

**Avec 13 délégations sur le territoire espagnol et 16 à l'étranger**, Infrico répond aux

que sus productos son fabricados en España, convirtiéndose así en la primera compañía del sector que logra este sello en nuestro país, tras superar con éxito su exhaustivo proceso de auditoría.

Sus centros de producción ubicados en Lucena, en la provincia de Córdoba, son unas de las instalaciones industriales más modernas de España. Tres plantas, Infrico, Infrico Supermarket e Impafri, que cuentan con una superficie total de **160.000 metros cuadrados** destinados a producción, actividades logísticas y oficinas.

ufactured in Spain, thus becoming the first company in this sector in Spain to achieve this seal after successfully completing its exhaustive audit process.

The Production Centers are located in Lucena, in the province of Cordoba, they are one of the most modern industrial facilities in Spain. Three plants that have a total area of **160.000 square meters** for production, logistics activities and offices.

besoins de ses clients de manière proche et en temps opportun, avec un système de production flexible et efficace.

Infrico dispose de trois centres de production, Infrico, Impafri et Infrico supermarket avec une superficie totale de **160.000 m2 dont 60.000 m2** dédiés à la fabrication.

# INDICE DEX DEX

**00**  
NOVEDADES  
NEWS  
NOUVELLES

**01**  
ENFRIADORES  
BOTTLE COOLERS  
REFROIDISSEURS

**02**  
MESAS  
UNDERCOUNTERS  
TABLES

**03**  
ARMARIOS  
REACH INS  
ARMOIRES

**04**  
ABATIDORES  
BLAST CHILLERS  
& FREEZERS  
CELLULES DE  
REFROIDISSEMENT

**05**  
LÍNEA AMERICANA  
AMERICAN LINE  
LIGNE AMERICAINE

**06**  
INFRICOOOL



**07**  
CAVAS & DRY AGING



**08** VITRINAS EXPOSITORAS  
DYSPLAY CASES  
VITRINES DE PRÉSENTATION



**09** MURALES  
MULTIDECKS  
VITRINES MURALES



**11** VITRINAS DE HELADERÍA-PASTELERÍA  
PASTRY - GELATO DISPLAY CASES  
VITRINES PÂTISSIÈRES



**10**  
SUPERMARKET



**12**  
MAQUINARIA HOSTELERÍA  
HORECA EQUIPMENT  
NEGOCE

## Delegaciones / Delegations / Délégations

### 1 - Oficina Central / Main Office / Usine de fabrication

**INFRICO S. L.** Ctra. de Aguilar a A-318 por Moriles, Km 15,5 - A-3132  
CP 14900 Lucena, Córdoba - España

☎ +34 957 51 30 68

☎ +34 957 59 11 83

✉ info@infrico.com

### 1 - JEFE DE VENTAS

**Luis Rivas Montalvo**

☎ 650 43 65 87

✉ luisrivas@infrico.com

### 2 - MADRID Y ZONA CENTRO

**Javier López / Alberto Moreno / José Castellanos**

☎ 682 68 21 25 / 627 75 22 38 / 666 41 92 41

☎ 91 684 60 96

☎ 91 684 61 06

✉ delegacioncentro@infrico.com

### 3 - CATALUÑA-ANDORRA

**Raúl Ballano / M<sup>a</sup>. José Verdú / Nacho Garat**

ITECNIC, S.L.

☎ 670 84 44 56 / 689 33 20 25 / 682 36 44 66

☎ 93 562 61 52

☎ 93 562 61 45

✉ info@itecnic.com

### 4 - CANARIAS

**Carlos Vega**

DICAFRI, S.L.

☎ 674 88 30 40

☎ 928 70 10 87

☎ 928 70 10 85

✉ comercial.dicafri@infrico.com

### 5 - SEVILLA, HUELVA Y CÁDIZ

**José Manuel Romana**

☎ 654 50 98 40

✉ josemanueldibeca@hotmail.com

### 6 - CÓRDOBA, JAÉN, MÁLAGA CEUTA, MELILLA

**Miguel Cantero**

☎ 620 29 82 82

✉ miguelcantero@infrico.com

### 7 - GRANADA, ALMERÍA Y MURCIA

**Daniel Riquelme Cordero**

☎ 659 85 04 15

✉ danielriquelmecordero@hotmail.com

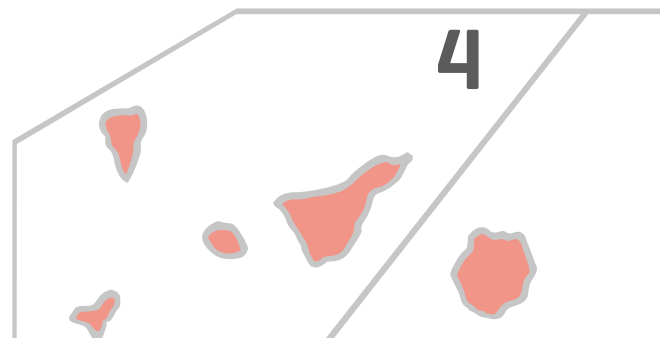
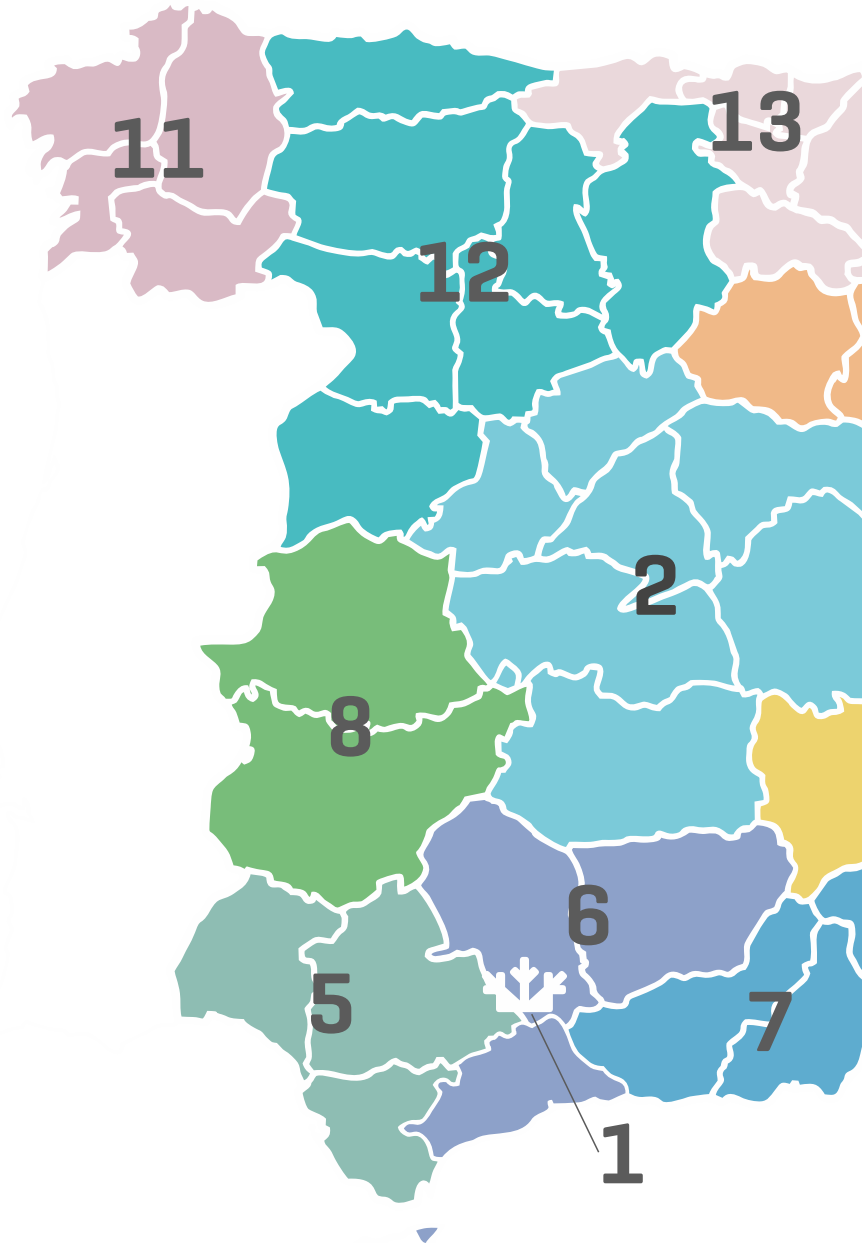

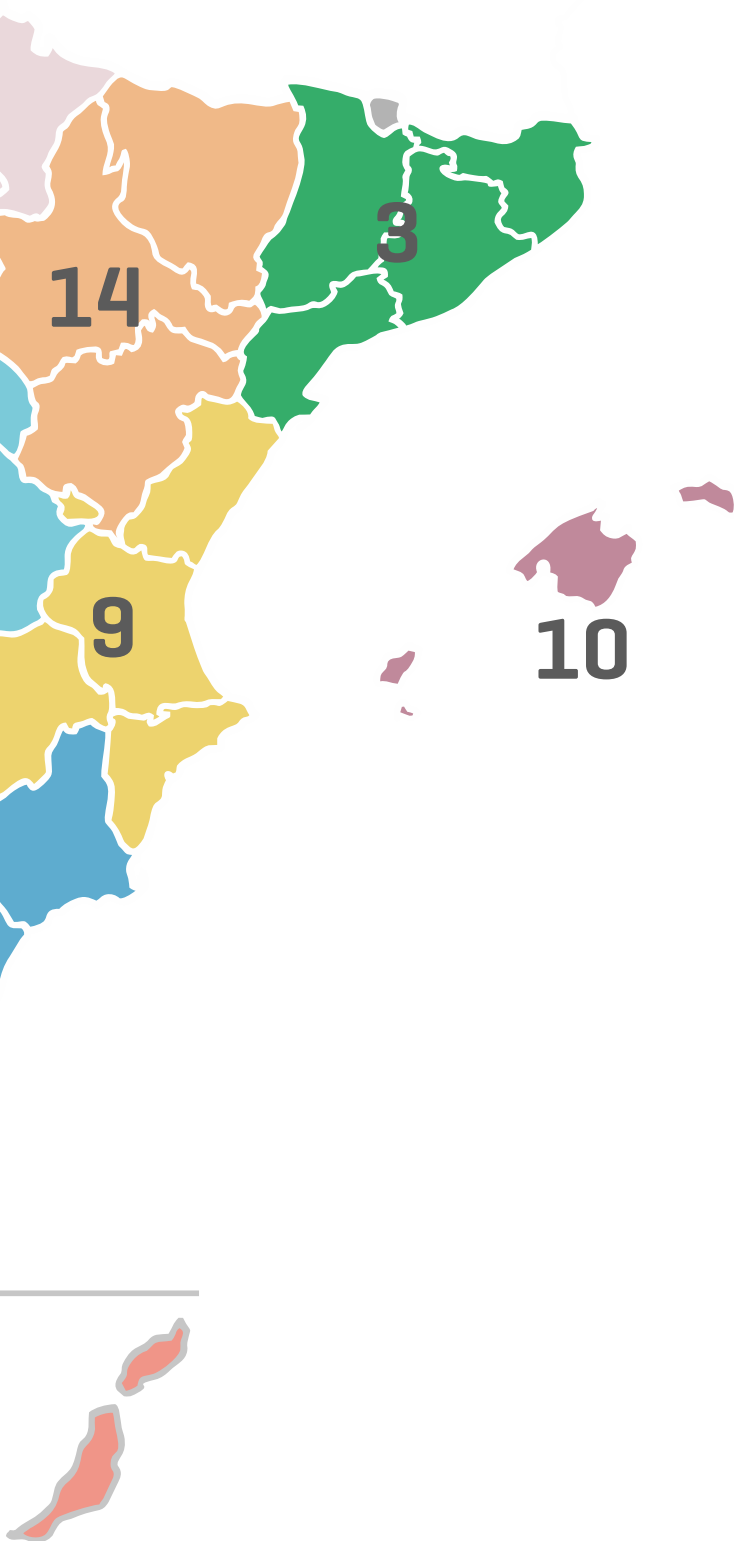
**8 - EXTREMADURA****Manuel Pérez Guisado**

☎ 670 03 23 56

☎ 924 45 61 91

✉ [manuel@representacionessmpg.com](mailto:manuel@representacionessmpg.com)**9 - VALENCIA, ALICANTE, CASTELLÓN Y ALBACETE****Victoria Oliver / Elena Oliver**

SILVINO OLIVER, S.L.

☎ 963 97 02 45

☎ 605 09 75 40

☎ 963 97 02 46

✉ [infricovalencia@silvinooliver.com](mailto:infricovalencia@silvinooliver.com)**10 - BALEARES****Manuel Castro Baños**

☎ 628 67 18 97

✉ [mcastro@infrico.com](mailto:mcastro@infrico.com)**11 - GALICIA****Juan José Espejo / Brais Espejo**

☎ 609 85 01 55 / 691 11 72 35

✉ [escohostel@escohostel.com](mailto:escohostel@escohostel.com)**12 - CASTILLA-LEÓN Y ASTURIAS****Paulino Canga González**

☎ 609 66 52 54

☎ 670 59 49 86

✉ [paulo@delegadoastur.com](mailto:paulo@delegadoastur.com)**13 - PAÍS VASCO, NAVARRA, LA RIOJA Y CANTABRIA****Mikel Pérez De Viñaspre**

☎ 650 25 56 34

✉ [mikelperez@infrico.com](mailto:mikelperez@infrico.com)**14 - ARAGÓN****Adolfo Bueno**

☎ 653 85 70 60

✉ [buenozaragoza@gmail.com](mailto:buenozaragoza@gmail.com)



**SALES MANAGER**

**Fran Ramón**

☎ +34 609 21 81 94  
✉ [framon@infrico.com](mailto:framon@infrico.com)

**INFRICO FRANCE / ITALY**

**Roberto Doval**

☎ +34 606 970 357  
✉ [rdoval@infrico.com](mailto:rdoval@infrico.com)

**IRELAND**

**Carlos Ortega**

☎ +34 669 65 99 01  
✉ [cortega@infrico.com](mailto:cortega@infrico.com)

**PORTUGAL**

**Rui Vigo**

Unipessoal Lda. Rui Vigo  
☎ + 351 915 283 253  
☎ + 351 309 955 122  
✉ [rui.vigo@netcabo.pt](mailto:rui.vigo@netcabo.pt)

**UK / BENELUX**

**Mark Botwright**

☎ +34 679 71 93 26  
✉ [mark@infrico.com](mailto:mark@infrico.com)

**NORTH EUROPE**

**Rafael Cañada**

☎ +34 630 44 79 29  
✉ [rafael@infrico.com](mailto:rafael@infrico.com)

**CENTRAL / EAST EUROPE**

**Dragan Cerkez**

☎ +34 608 808 971  
✉ [dragan@infrico.com](mailto:dragan@infrico.com)

**SUIZA / SWITZERLAND**

**Remzi Alili**

Resan Enfrico Sàrl  
☎ + 41 79 589 32 01  
☎ + 41 21 671 70 70  
✉ [resanenfrico@resanenfrico.ch](mailto:resanenfrico@resanenfrico.ch)

**INFRICO MAROC /  
ÁFRICA /  
ARABIA SAUDI**

**Aziz Bouhartan**  
☎ + 212 661 107 372  
☎ + 212 522 207 372  
✉ [aziz.bouhartan@infrico.com](mailto:aziz.bouhartan@infrico.com)

**SOUTHAFRICA  
Culinary**

☎ +27 0 11 701 2200  
✉ [info@culinary.co.za](mailto:info@culinary.co.za)

**TURKEY / CENTRAL ASIA**

**Dogan Bademkiran**  
☎ + 90 545 583 6315  
✉ [dogan@infrico.com](mailto:dogan@infrico.com)

**MIDDLE EAST /  
INDIA SUB / EGIPT**

**Sushil Hiranandani**  
☎ +971528 496385  
✉ [middle-east@infrico.com](mailto:middle-east@infrico.com)

**ASIA-PACIFIC**

**Rafael Pérez**  
☎ +34 620 000 938  
✉ [rperez@infrico.com](mailto:rperez@infrico.com)





**NORTH AMERICA**

**Pedro Carvajal**

☎ +34 690 23 44 78  
✉ [pcarvajal@infrico.com](mailto:pcarvajal@infrico.com)

**INFRICO USA**

**Juan Pablo Esparragoza**

☎ 1.855.340.4637  
✉ [sales@infrico.com](mailto:sales@infrico.com)

**USA**

**Carlos Ortega Doval**

☎ +34 669 65 99 01  
✉ [cortega@infrico.com](mailto:cortega@infrico.com)

**CANADA**

**Axom Group**

**Eastern: Xavier Lavigne**

☎ +1 514 825 2966  
✉ [xavier@axomgroup.ca](mailto:xavier@axomgroup.ca)

**Western: Christiaan van den Hoven**

☎ +1 604 889 2966  
✉ [chris@axomgroup.ca](mailto:chris@axomgroup.ca)

**MÉXICO**

**Francisco Pedroche**

Sinergias  
☎ +33 3630 4547 / +33 3615 7926  
✉ [ventas@sinergiasmx.com](mailto:ventas@sinergiasmx.com)

**LATINOAMÉRICA**

**Antonio Mendoza**

☎ +34 682 65 57 84  
✉ [amendoza@infrico.com](mailto:amendoza@infrico.com)

**REPÚBLICA DOMINICANA**

**Rafael Podadera**

Parlyn International  
☎ + 18097594424  
✉ [rpodadera@parlyninternational.com](mailto:rpodadera@parlyninternational.com)

**PUERTO RICO**

**Alexandre Vargas**

Global Kitchen Solutions  
☎ +1 787 923 9365  
✉ [alexandre@globalkitchensolutions.com](mailto:alexandre@globalkitchensolutions.com)

**PANAMA**

**Juan Gabriel Martinez**

☎ +507 6676 8092  
✉ [jmartinez@equipcopanama.com](mailto:jmartinez@equipcopanama.com)

**COLOMBIA**

**Fernando Toro**

☎ +57 313 452 1306  
✉ [ftoro@infrico.com](mailto:ftoro@infrico.com)

**ECUADOR / PERÚ / BOLIVIA**

**Giovanni Pedrazzoli**

☎ +59 399 118 6962  
✉ [gpedrazzoli@infrico.com](mailto:gpedrazzoli@infrico.com)

**CHILE**

**Josué Meléndez**

Comercial Maquinet  
☎ Tel.: +56 98199 3973  
✉ [ventas@maquinet.cl](mailto:ventas@maquinet.cl)

## Délégations France

**infrico.fr** 📍 ZAC des Portes d'Océane OUEST. 72650 SAINT SATURNIN [FRANCE]

☎ 02 43 42 00 33

📠 02 43 42 28 07

### Direction

#### Roberto Doval:

☎ +34 606 97 03 57

✉ rdoval@infrico.com

### Direction

#### Commerciale

#### Jerome Crespel

☎ 06 08 64 39 76

✉ jerome@infrico.com

### Direction

#### Administrative

#### Sophia Choukri

☎ 06 58 04 33 15

✉ sophia@infrico.com

### Service Compatibilité et Facturation

#### Valerie Simon:

☎ 07 61 98 47 50

☎ 02 43 42 00 33

✉ comptabilite@infrico.com

### Service SAV

#### Stephane Vivet: Pièces détachées

☎ 02 53 49 17 23

✉ pieces@infrico.com

### Miguel Burgos: SAV

☎ 02 53 49 17 22

✉ sav@infrico.com

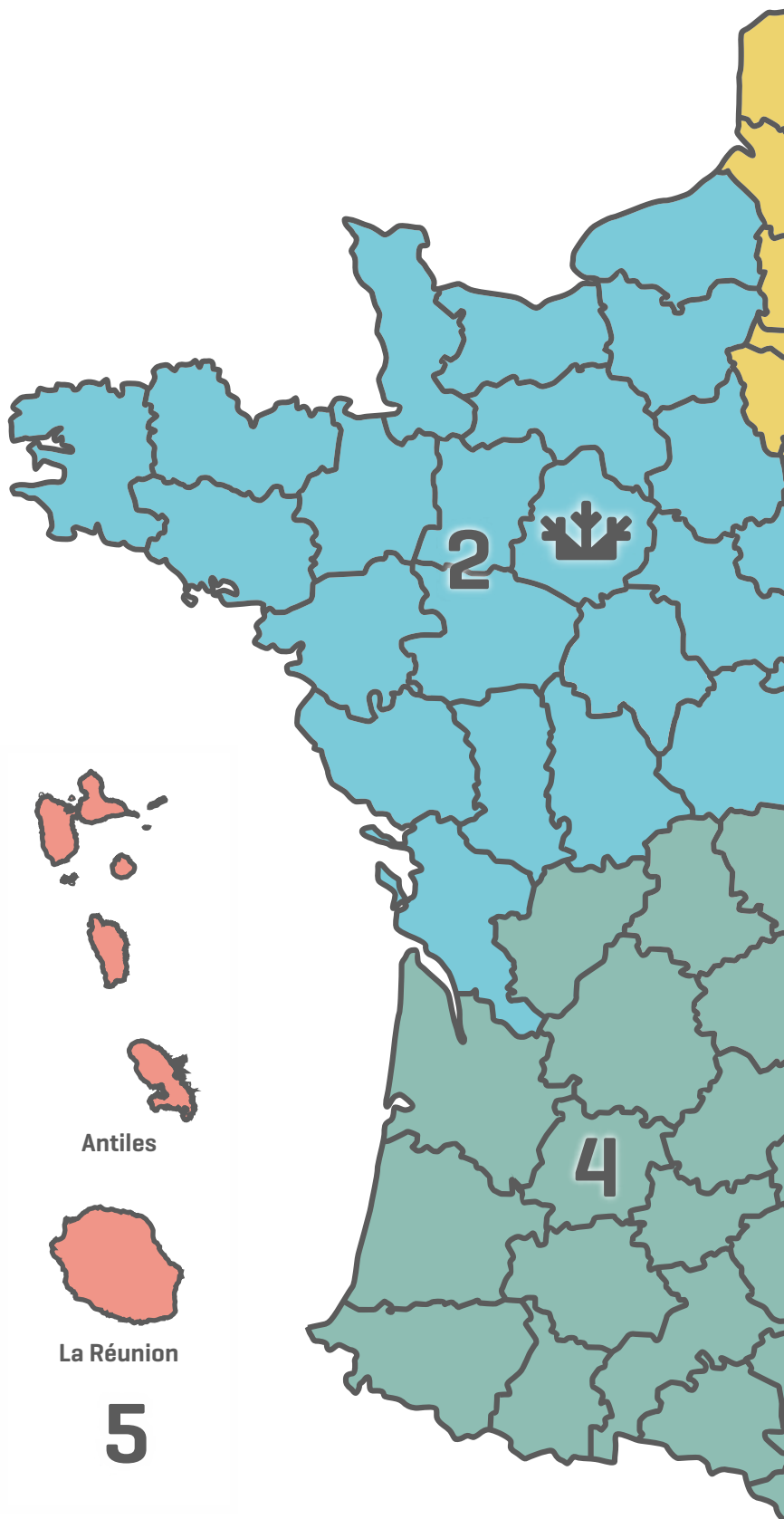

+Info: [www.infrico.com](http://www.infrico.com)

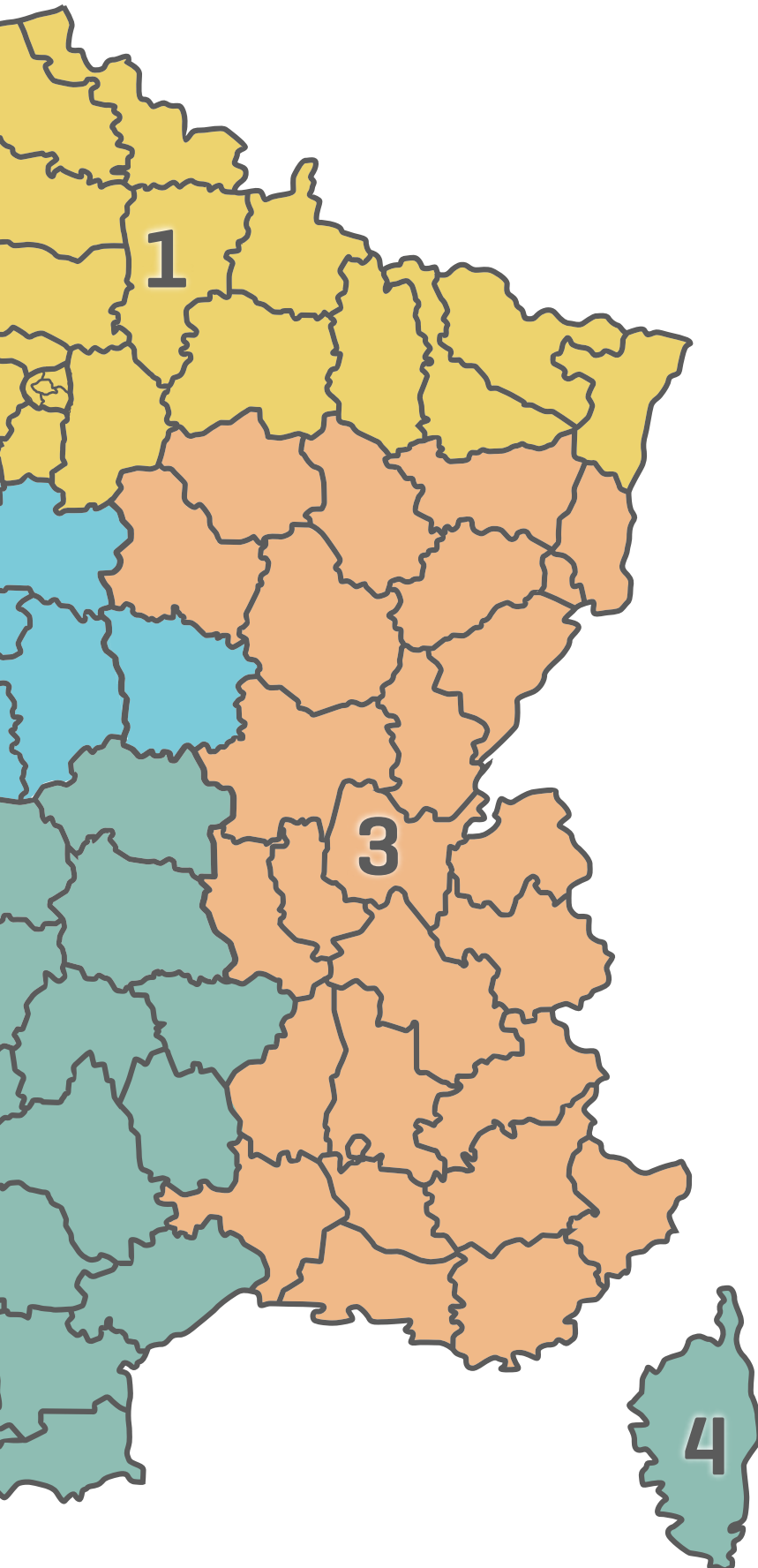

### **SECTEUR 1**

**Paris - Île de France  
Nord - Est**

**Mickaël Diaz:**  
mickael@infrico.com  
Tél: 06 07 23 00 97

### **SECTEUR 2**

**Nord-Ouest**

**Jerome Crespel:**  
jerome@infrico.com  
Tél: 06 08 64 39 76

### **SECTEUR 3**

**Sud Est**

**Maxime Bernigaud**  
mbernigaud@infrico.com  
Tél: 06 74 91 73 03

### **SECTEUR 4**

**Sud Ouest - Corse**

**Vincent Lecocq:**  
vincent@infrico.com  
Tél: 07 72 77 49 65

### **OUTRE MER - 5**

**La Martinique, Guadeloupe, La  
Réunion, Mayotte, La Guyane,  
Nouvelle Calédonie**

**Claire Brossier**  
commercial@infrico.com  
Tél: 06 44 17 72 17



**14 Delegaciones**  
 14 Delegations  
 14 Délégations



**21 Delegaciones**  
 21 Delegations  
 21 Délégations



**Más de 700 trabajadores**  
 More than 700 employees  
 Plus de 700 employés



**Certificado Origen Español**  
 Spanish Origin Certificate  
 Certificat d'Origine Espagnol



**160.000 m<sup>2</sup> dedicados a la fabricación de equipos de refrigeración comercial de última generación**

**160.000 m<sup>2</sup> dedicated to the manufacture of commercial refrigeration equipment of last generation**

**160.000 m<sup>2</sup> dédiés à la fabrication de produits de réfrigération commerciale de pointe**





Colaboramos / We collaborate / En collaboration avec



Participamos en / We participate in / Nous sommes présents



Responsabilidad Social Corporativa [RSC]  
Corporate Social Responsibility [CSR]  
Responsabilité Sociale des Entreprises [RSC]



Asociación  
española  
contra el cáncer

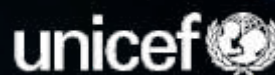

Patrocinador / Sponsor  
Club Deportivo Lucena

## Ferias y Exhibiciones / Fairs and Exhibitions / Salons et Expositions

Infrico está presente en las principales ferias internacionales del sector, donde año tras año presenta las novedades, diseños y avances tecnológicos de sus productos.

Infrico is present at the main international fairs of the sector, where year after year we present the novelties, designs and technological advances of our products.

Infrico est présent dans les principaux salons du secteur, durant lesquels années après années, sont présentées les nouveautés et dernières avancées techniques de ses produits.





+Info: [www.infrico.com](http://www.infrico.com)





# Novedades

New Products / Lancements



**MINIMARKET**  
ERC50PH / BT



**GN1/1 700**  
BMGN1470A

Clase energ.  
Energy class  
Classe Énerg.  
**A+**  
**INVERTER**



**GN2/1**  
AGB701A



**UC (American Line)**  
UC48PMT  
UC27RCR



UC27P

**MR (American Line)**  
MR67



MR41EN

**MSG BT**



**NACIONAL 400/900L**

AN401CR

AN902CR



**BarStation**



**iLine**



**MPG (American Line)**  
MPG1490



**AC MDA / EVV**  
AC140MDAB



EVV70



**VISION**  
VCD10

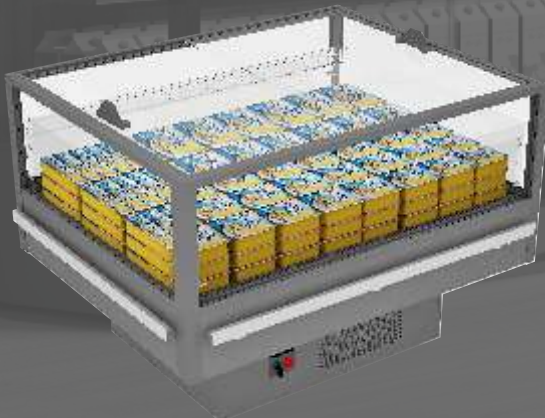

**COMBI**  
AS25U



+Info: [www.infrico.com](http://www.infrico.com)

**JULIET**  
VJU18P



**EXPERIENCE**  
VEX18UCP



**BIGGIE**  
VPG37



**ÁMBAR**  
VBR9PC / VBR PSS / VBR PDS



# Waterin

Sistema Waterloop R290 de Infrico

hasta  
**-25%**

Sistema eficiente, hasta el 25% de ahorro de energía.

Efficient system with up to 25% energy saving.

Système efficace avec jusqu'à 25 % d'économies d'énergie.

**-75%**

75% reducción carga refrigerante.

75% refrigerant charge reduction.

Réduction de 75 % de la charge de réfrigérant.

**0€**

Refrigerantes naturales SIN TASA.

Natural refrigerants WITHOUT CHARGE.

Réfrigérateurs naturels SANS TÂCHE.



Mínima carga refrigerante, aprox. 0.1kg/kw.

Minimum refrigerant load, aprox. 0.1kg/kw.

Charge minimale de réfrigérant, avec environ 0,1 Kg/kw de réfrigération.



Flexibilidad de implantación.  
Flexibility of implementation.  
Flexibilité de mise en oeuvre.



Recuperación de calor en la instalación.  
Heat recovery in the installation.  
Récupération de chaleur dans l'installation.



Condensadores sin mantenimiento.  
Maintenance-free condensers.  
Condensateurs de maintenance.



Posible eliminación de la sala de máquinas.  
Possible elimination of the machine room.  
Élimination possible, dans de nombreux cas, de la salle des machines.



Eliminación de riesgos típicos de inst. centralizadas.  
Elimination of the typical risks of central. installations.  
Élimination des risques typiques des installations centralisées.



Menor riesgo de fugas.  
Reduced risk of leakage.  
Moins de risques de fuites.

## FHC ICE CUBE

FHIKU26AHC



FHDSS42A/W



## CONGELADOR/FREEZER/CONGÉLATEURS -70°C

UL100





**VISION**

EHCV2000VSC



**400L**

RV400SD



FS400GD



**HT**

HT2021



**SALAMANDRA**

ULTRA-RÁPIDA CONTACT /  
ULTRARAPID CONTACT /  
ULTRA-RAPIDE CONTACT



# Enfriadores

Boottle Cooler / Refroidisseur de bouteilles





Infrico

4.0



Serie / Series / Série

# EFP



EFP EG  
EFP II \_\_\_\_\_ 32-33

Serie / Series / Série

# EBC



EB II \_\_\_\_\_ 34-35

Serie / Series / Série

# ERV (850/920)



ERV SH  
ERV II SH  
ERV PP  
ERV  
ERV C \_\_\_\_\_ 36-39

Serie / Series / Série

# ERV inox



ERV II  
ERV PP II \_\_\_\_\_ 40-41

Serie / Series / Série

# ERV / ERC



ERV  
ERC  
ERC B \_\_\_\_\_ 42-43

Serie / Series / Série

# MINIMARKET



ERC PH  
ERC PH BT \_\_\_\_\_ 44-45

Serie / Series / Série

# NEC



NEC RV  
NEC FS  
NEC FV \_\_\_\_\_ 46-47

Serie / Series / Série

# SUPERCOOLER



SPC  
SPC B \_\_\_\_\_ 48-49

Serie / Series / Série

# ESC / TA



ESC  
ESC CR  
TA II \_\_\_\_\_ 50-51

+Info: [www.infrico.com](http://www.infrico.com)



Digital control easy and intuitive—touch screen IP65 protection.

# 1. Enfriadores

## Bottle coolers / Refroidisseurs de bouteilles

### Iluminación / Lighting / Éclairage

Incorporación de iluminación LED, llegando a reducir el consumo energético entre un 80% y 90%, respecto a una bombilla tradicional. RGB opcional.

LED lighting incorporated, reducing energetic consumption between 80% and 90% respect to a traditional light bulb. RGB optional.

Éclairage LED, réduisant la consommation énergétique entre 80% et 90%, par rapport à une ampoule traditionnelle. RGB optionnel.



Cabezal iluminado opcional.

Option Canopy.

Canopy en option.



Doble acristalamiento templado, bajo emisor con carga de Argón [4-27-4].

Double tempered glass, low-e with argon charge [4-27-4].

Triple vitrage et verre trempé [4-12-3-12-4].



Nuevo Co  
intuitivo I

New Digit  
intuitive-

Nouveau  
intuitif IP

+Info: [www.infrico.com](http://www.infrico.com)



Controlador digital táctil e IP 65.

Digital control easy and touch screen IP65 protection.

Contrôleur digital tactile e IP 65.



Nuevo Controlador digital táctil e intuitivo IP 65.







New Digital control easy and intuitive-touch screen IP65 protection.

Nouveau Contrôleur digital tactile e intuitif IP 65.



# Refrigerador de botellas / Chest bottle cooler / Refroidisseur de bouteilles



MODELO MODELE MODÈLE						
	EFP 1000 EG	EFP 1500 EG	EFP 2000 EG	EFP 1000 II	EFP 1500 II	EFP 2000 II
<b>Precio</b> Price Prix						
<b>Medidas</b> Measures [mm] Mesures	1004 x 550 x 880 mm.	1479 x 550 x 880 mm.	1954 x 550 x 880 mm.	1004 x 550 x 880 mm.	1479 x 550 x 880 mm.	1954 x 550 x 880 mm.
<b>Temperatura</b> Temperature Température	+3°C/+6°C					
<b>Clase Climática</b> Climatic class Classe climatique	4 / 38°C					
<b>Tensión/Frecuencia</b> Electrical data Tension électrique	230V/1ph/50Hz					
<b>Controlador</b> Controller Régulateur	Termostático / Thermostatic / Thermostatique					
<b>Material</b> Material [EXT/INT] Matériel	Exterior plastificado blanco / Encimera INOX AISI 304 Exterior prepainted / INOX AISI 304 worktop Extérieur plastifié blanc / Dessus INOX AISI 304			Encimera INOX AISI 304 / Interior-Exterior AISI 430 INOX AISI 304 Worktop / AISI 430 Interior-Exterior Dessus INOX AISI 304 / Intérieur-Extérieur AISI 430		
<b>Espesor</b> Thickness Épaisseur	40					
<b>Aislamiento</b> Isolation Isolation	40kg/m <sup>3</sup> / Free CFC's / Zero ODP-GWP					
<b>Capacidad</b> Capacity Capacité	200	305	415	200	305	415
<b>Puertas</b> Doors Portes	2	3	4	2	3	4
<b>Nº separadores</b> Nº dividers Nº séparateurs	1	2	3	1	2	3
<b>Sistema de frío</b> Cooling System Système de froid	Condensación Forzado / Forced air condensation / Condensation Ventilé Evaporador estático / Static evaporator / Évaporateur statique					
<b>Desescarche</b> Defrost Dégivrage	-					
<b>Expansión</b> Expansion Expansion	Capilar / Capillary / Capillaire					
<b>Potencia</b> Power Puissance	122	180	180	122	180	180
<b>Potencia frig.</b> Cooling capacity Puissance Frig.	169	370	370	169	370	370
<b>Consumo</b> Consumption Consommation	-					
<b>Clase energética</b> Energy class Classe Énerg.	-					
<b>Refrigerante</b> Refrigerant Gaz	<b>R-600a</b>	<b>R-290</b>		<b>R-600a</b>	<b>R-290</b>	
<b>Opcional</b> Optional Options	Separador / Divider / Séparateur (504X26) 115V/1 ph/60 Hz 230V/1 ph/60 Hz					



Serie / Series / Série **EFP**

+Info: [www.infrico.com](http://www.infrico.com)



EFP 2000 EG

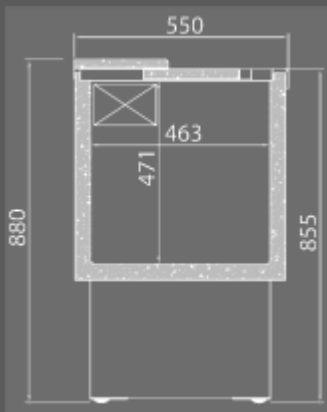

EFP 1000 II









EFP 1500 EG

# Refrigerador de botellas / Chest bottle cooler / Refrigerateur de bouteilles (EB)

# Refrigerador de botellas con cajones / Chest bottle cooler with drawers / Refrigerateur de bouteilles avec tiroirs (EBC)



MODELO MODELE MODÈLE							
	EB 1000 II	EB 1500 II	EB 2000 II	EB 2500 II	EBC 1000 II	EBC 1500 II	EBC 2000 II
<b>Precio</b> Price Prix							
<b>Medidas</b> Measures [mm] Mesures	1004 x 550 x 865 mm.	1479 x 550 x 865 mm.	1954 x 550 x 865 mm.	2429 x 550 x 865 mm.	1004 x 550 x 865 mm.	1479 x 550 x 865 mm.	1954 x 550 x 865 mm.
<b>Temperatura</b> Temperature Température	+3°C/+6°C						
<b>Clase Climática</b> Climatic class Classe climatique	4 / 38°C						
<b>Tensión/Frecuencia</b> Electrical data Tension électrique	230V/1ph/50Hz						
<b>Controlador</b> Controller Régulateur	-						
<b>Material</b> Material [EXT/INT] Matériel	Encimera INOX AISI 304 / Interior-Exterior AISI 430 INOX AISI 304 Worktop / AISI 430 Interior-Exterior Dessus INOX AISI 304 / Interior-Extérieur AISI 430						
<b>Espesor</b> Thickness Épaisseur	40						
<b>Aislamiento</b> Isolation Isolation	40kg/m <sup>3</sup> / Free CFC's / Zero ODP-GWP						
<b>Capacidad</b> Capacity Capacité	265	445	620	800	265	445	620
<b>Puertas</b> Doors Portes	2	3	4	5	2	3	4
<b>Nº Separadores</b> Nº Dividers Nº Séparateur	1	2	3	4	1	2	3
<b>Sistema de frío</b> Cooling System Système de froid	Forzado / Forced air / Ventilé Evaporador estático / Static evaporator / Évaporateur statique						
<b>Desescarche</b> Defrost Dégivrage	-						
<b>Expansión</b> Expansion Expansion	Capilar / Capillary / Capillaire						
<b>Potencia</b> Power Puissance	122	180	180	355	122	180	180
<b>Potencia frig.</b> Cooling capacity Puissance Frig.	169	370	370	690	169	343	343
<b>Consumo</b> Consumption Consommation	-						
<b>Clase energética</b> Energy class Classe Énerg.	-						
<b>Refrigerante</b> Refrigerant Gaz	<b>R-600a</b>	<b>R-290</b>			<b>R-600a</b>	<b>R-290</b>	
<b>Opcional</b> Optional Options	Separador / Divider / Séparateur [504X32]						
	115V/1 ph/60 Hz 230V/1 ph/60 Hz						

Serie / Series / Série **EB / EBC**

+Info: [www.infrico.com](http://www.infrico.com)



EBC 2000 II

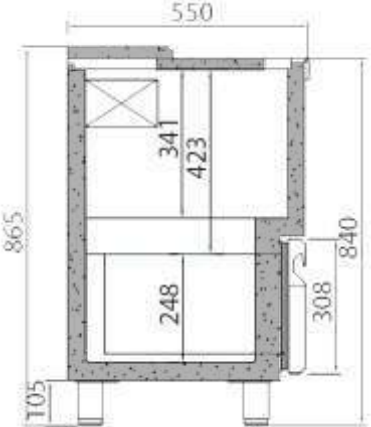
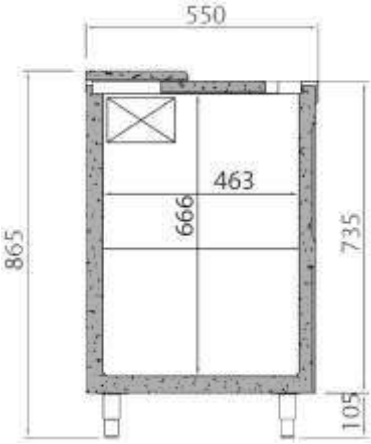

EB 1000 II









EBC 1000 II



# Expositor refrigerado horizontal altura 850mm / Back-Bar 850mm height / Arrière bar horizontal hauteur 850mm

1

MODELO MODELE MODÈLE						
	ERV 15 SH	ERV 25 SH	ERV 35 SH	ERV 15 II SH	ERV 25 II SH	ERV 35 II SH
Precio Price Prix						
Medidas Measures [mm] Mesures	600 x 510 x 850 mm.	900 x 510 x 850 mm.	1350 x 510 x 850 mm.	600 x 510 x 850 mm.	900 x 510 x 850 mm.	1350 x 510 x 850 mm.
Temperatura Temperature Température	+4°C/+12°C					
Clase Climática Climatic class Classe climatique	4 / 38°C					
Tensión/Frecuencia Electrical data Tension électrique	230V/1ph/50Hz					
Controlador Controller Régulateur	Digital / Digital / Électronique IP65					
Material Material [EXT/INT] Matériel	Exterior acero plastificado negro / Interior acero plastificado gris Black plastic coated steel exterior / Grey plastic coated steel interior Extérieur acier plastifié noir / Intérieur acier plastifié gris			Interior plastificado gris / Exterior INOX AISI 430 Interior prepainted grey / INOX AISI 430 Exterior Intérieur plastifié gris / Extérieur INOX AISI 430		
Espesor Thickness Épaisseur	30					
Aislamiento Isolation Isolation	40kg/m <sup>3</sup> / Free CFC's / Zero ODP-GWP					
Capacidad Capacity Capacité	124	193	296	124	193	296
Puertas Doors Portes	1	2	3	1	2	3
Nº parrillas J. guías Nº shelves / Slides Nº de grilles / Glissière	2	2	2	2	2	2
Sistema de frío Cooling System Système de froid	Forzado / Forced air / Ventilé					
Desescarche Defrost Dégivrage	Automático / Automatic / Automatique					
Expansión Expansion Expansion	Capilar / Capillary / Capillaire					
Potencia Power Puissance	250	320	259	250	320	259
Potencia fríg. Cooling capacity Puissance Frig.	370					
Consumo Consumption Consommation	-					
Clase energética Energy class Classe Énerg.	-					
Refrigerante Refrigerant Gaz	R-290					
Opcional Optional Options	Iluminación Led RGB con cambio de color [por puerta] / Led lighting RGB change of colour [per door] / LED RGB avec changement de couleur [par porte] 115V/1 ph/60 Hz 230V/1 ph/60 Hz					

Serie / Series / Série **ERV**

+Info: [www.infrico.com](http://www.infrico.com)

ERV 25 SH



Controlador digital IP 65.  
Digital control IP65  
Contrôleur digital IP 65.

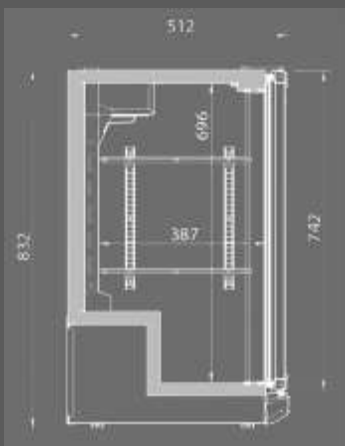







ERV 35 II SH

# Expositor refrigerado horizontal altura 920mm / Back-Bar 920mm height / Arrière bar horizontal hauteur 920mm

1

Puertas correderas  
Sliding doors  
Portes coulissantes

MODELO MODELE MODÈLE							
	ERV 15 PP	ERV 25 PP	ERV 35 PP	ERV 15	ERV 25	ERV 35	ERV 25 C
<b>Precio</b> Price Prix							
<b>Medidas</b> Measures [mm] Mesures	600 x 510 x 920 mm.	900 x 510 x 920 mm.	1350 x 510 x 920 mm.	600 x 510 x 920 mm.	900 x 510 x 920 mm.	1350 x 510 x 920 mm.	900 x 510 x 920 mm.
<b>Temperatura</b> Temperature Température	+4°C/+8°C			+4°C/+12°C			
<b>Clase Climática</b> Climatic class Classe climatique	4 / 38°C						
<b>Tensión/Frecuencia</b> Electrical data Tension électrique	230V/1ph/50Hz						
<b>Controlador</b> Controller Régulateur	Digital / Digital / Électronique IP65						
<b>Material</b> Material [EXT/INT] Matériel	Exterior acero plastificado negro / Interior acero plastificado gris Black plastic coated steel exterior / Grey plastic coated steel interior Extérieur acier plastifié noir / Intérieur acier plastifié gris						
<b>Espesor</b> Thickness Épaisseur	30						
<b>Aislamiento</b> Isolation Isolation	40kg/m <sup>3</sup> / Free CFC's / Zero ODP-GWP						
<b>Capacidad</b> Capacity Capacité	140	220	330	140	220	330	220
<b>Puertas</b> Doors Portes	1	2	3	1	2	3	2
<b>N° parrillas / Guías</b> N° shelves / Slides N° de grilles / Glissière	2						
<b>Sistema de frío</b> Cooling System Système de froid	Forzado / Forced air / Ventilé						
<b>Desescarche</b> Defrost Dégivrage	Automático / Automatic / Automatique						
<b>Expansión</b> Expansion Expansion	Capilar / Capillary / Capillaire						
<b>Potencia</b> Power Puissance	250	320	325	250	320	325	320
<b>Potencia frig.</b> Cooling capacity Puissance Frig.	370						
<b>Consumo</b> Consumption Consommation	-						
<b>Clase energética</b> Energy class Classe Énerg.	-						
<b>Refrigerante</b> Refrigerant Gaz	R-290						
<b>Opcional</b> Optional Options	Iluminación Led RGB con cambio de color (por puerta) / Led lighting RGB change of colour (per door) / LED RGB avec changement de couleur (par porte) Parrilla / Wire shelf / Grille ERV15 (502X27) Parrilla / Wire shelf / Grille ERV25 (502X28) Parrilla / Wire shelf / Grille ERV35 (502X31) 115V/1 ph/60 Hz 230V/1 ph/60 Hz						

Serie / Series / Série **ERV**

+Info: [www.infrico.com](http://www.infrico.com)

ERV 25 PP



**Video del producto**  
Product Video  
Vidéo du produit



**Infrico Youtube**



ERV 15



ERV 25

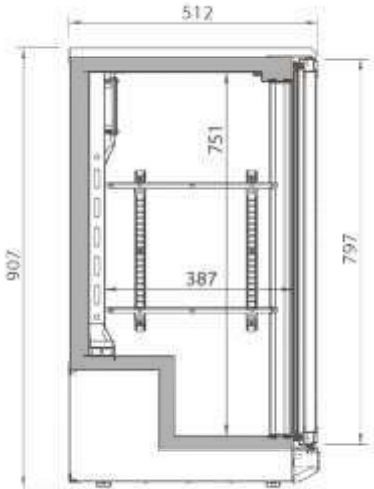

Los datos técnicos están sujetos a posibles variaciones que serán actualizadas periódicamente en las fichas técnicas del producto, disponibles en la web /  
The technical data are subject to possible variations that will be updated periodically in the technical data sheets of the product, which are available on the website /  
Les données techniques peuvent varier et seront actualisées dans les fiches techniques du produit, disponibles sur le site web.

# Expositor refrigerado horizontal altura 920mm / Back-Bar 920mm height / Arrière bar horizontal hauteur 920mm

REFRIGERACIÓN / REFRIGERATOR / POSITIF / 920mm †

MODELO  
MODELE  
MODÈLE



ERV 15 II

ERV 25 II

ERV 35 II

ERV 15 PP II

ERV 25 PP II

ERV 35 PP II

Precio Price Prix							
<b>Medidas</b> Measures [mm] Mesures	↔ ↕	600 x 510 x 920 mm.	900 x 510 x 920 mm.	1350 x 510 x 920 mm.	600 x 510 x 920 mm.	900 x 510 x 920 mm.	1350 x 510 x 920 mm.
<b>Temperatura</b> Temperature Température	[°C]	+4°C/+12°C					
<b>Clase Climática</b> Climatic class Classe climatique	[°C]	4 / 38°C					
<b>Tensión/Frecuencia</b> Electrical data Tension électrique		230V/1ph/50Hz					
<b>Controlador</b> Controller Régulateur		Digital / Digital / Électronique IP65					
<b>Material</b> Material [EXT/INT] Matériau		Interior plastificado gris / Exterior INOX AISI 430 Interior prepainted / INOX AISI 430 Exterior Intérieur plastifié gris / Extérieur INOX AISI 430					
<b>Espesor</b> Thickness Épaisseur	[mm]	30					
<b>Aislamiento</b> Isolation Isolation	[mm]	40kg/m <sup>3</sup> / Free CFC's / Zero ODP-GWP					
<b>Capacidad</b> Capacity Capacité	[L]	140	220	330	140	220	330
<b>Puertas</b> Doors Portes		1	2	3	1	2	3
<b>N° parrillas / Guías</b> N° shelves / Slides N° de grilles / Glissière		2					
<b>Sistema de frío</b> Cooling System Système de froid		Forzado / Forced air / Ventilé					
<b>Desescarche</b> Defrost Dégivrage		Automático / Automatic / Automatique					
<b>Expansión</b> Expansion Expansion		Capilar / Capillary / Capillaire					
<b>Potencia</b> Power Puissance	[W]	250	320	325	250	320	325
<b>Potencia frig.</b> Cooling capacity Puissance Frig.	[W A -10°C]	370					
<b>Consumo</b> Consumption Consommation	[kWh/ 24h]	-					
<b>Clase energética</b> Energy class Classe Énerg.		-					
<b>Refrigerante</b> Refrigerant Gaz		R-290					
<b>Opcional</b> Optional Options		Iluminación Led RGB con cambio de color [por puerta] / Led lighting RGB change of colour [per door] / LED RGB avec changement de couleur [par porte] Parrilla / Wire shelf / Grille ERV15 [502X27] Parrilla / Wire shelf / Grille ERV25 [502X28] Parrilla / Wire shelf / Grille ERV35 [502X31] 115V/1 ph/60 Hz 230V/1 ph/60 Hz					



Serie / Series / Série **ERV INOX / ERV PP**

+Info: [www.infrico.com](http://www.infrico.com)

ERV 25 PP II



Controlador digital IP 65.  
Digital control IP65  
Contrôleur digital IP 65.



ERV 35 II

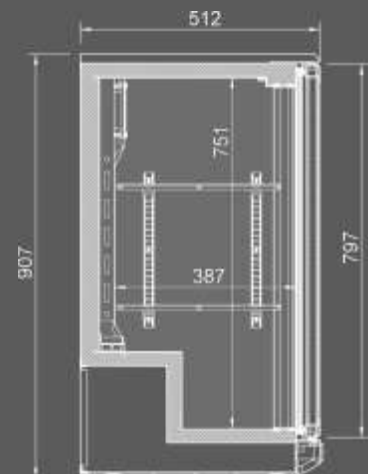

# Expositor refrigerado vertical / Glass door merchandiser / Armoire d'exposition réfrig. verticale

# Expositor refrigerado vertical / Glass door merchandiser / Armoire d'exposition réfrig. verticale

REFRIGERACIÓN / REFRIGERATOR / POSITIF



MODELO  
MODELE  
MODÈLE

ERV 53

ERV 83

ERC 36 B

ERC 100

ERC 130

ERC 200

Precio Price Prix						
Medidas Measures [mm] Mesures	600 x 510 x 1820 mm.	900 x 510 x 1820 mm.	620 x 595 x 1870 mm.	1385 x 704 x 2005 mm.	1385 x 804 x 2005 mm.	2081 x 804 x 2005 mm.
Temperatura Temperature Température	+4°C/+12°C			+4°C/+8°C		
Clase Climática Climatic class Classe climatique	4 / 38°C					
Tensión/Frecuencia Electrical data Tension électrique	230V/1ph/50Hz					
Controlador Controller Régulateur	Digital / Digital / Électronique IP65					
Material Material [EXT/INT] Matériau	Ext. acero plastif. negro / Int. acero plastificado gris Black plastic coated steel ext. / Grey plastic coated steel int. Ext. acier plastifié noir / Int. acier plastifié gris			Ext/Int acero plastificado blanco White plastic coated steel exterior/interior Extérieur/Intérieur acier plastifié blanc		
Espesor Thickness Épaisseur	30			50		
Aislamiento Isolation Isolation	40kg/m <sup>3</sup> / Free CFC's / Zero ODP-GWP					
Capacidad Capacity Capacité	280	435	355	1110	1310	2030
Puertas Doors Portes	1	2	1	2		3
Nº parrillas / Guías Nº shelves / Slides Nº de grilles / Glissière	5			4		
Sistema de frío Cooling System Système de froid	Ventilado / Forced air / Ventilé					
Desescarche Defrost Dégivrage	Parada de compresor / Compressor off / Arrêt du compresseur					
Expansión Expansion Expansion	Capilar / Capillary / Capillaire					Válvula termostática / Expansion valve / Détendeur thermostatique
Potencia Power Puissance	190	443	400	795	787	1111
Potencia frig. Cooling capacity Puissance Frig.	370	690	370	950	1296	1440
Consumo Consumption Consommation	1,67	3,39	-	5,8	6,8	9,2
Clase energética Energy class Classe Énerg.	<b>A</b>	<b>B</b>	-	<b>B</b>	<b>C</b>	
Refrigerante Refrigerant Gaz	<b>R-290</b>					
Opcional Optional Options	Iluminación Led RGB con cambio de color [por puerta] / Led lighting RGB change of colour [per door] / LED RGB avec changement de couleur [par porte]		Iluminación Led RGB con cambio de color [por puerta] / Led lighting RGB change of colour [per door] / LED RGB avec changement de couleur [par porte]			
	Parrilla / Wire shelf / Grille ERV53 [502X27]	Parrilla / Wire shelf / Grille ERV83 [502X28]	115V/1 ph/60 Hz		230V/1 ph/60 Hz	
	Cabezal iluminado / Illuminated canopy / Bandeau lumineux		-		Interior - Exterior / Interior - Exterior / Intérieur - extérieur Negro / Black / Noir RAL 9017	

Serie / Series / Série **ERV**  
 Serie / Series / Série **ERC**

+Info: [www.infrico.com](http://www.infrico.com)

Cabezal iluminado  
 Canopy illuminated  
 Bandeau lumineux



ERC 200

ERC 130 / 200



ERC 100

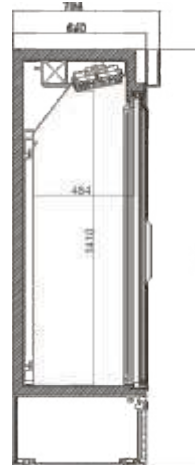

ERV 83

Video del producto  
 Product Video  
 Vidéo du produit



Infrico Youtube

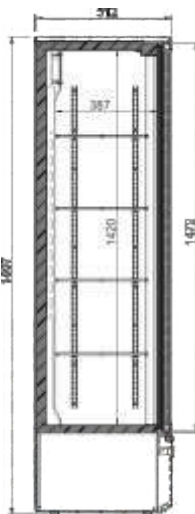

ERC 36 B

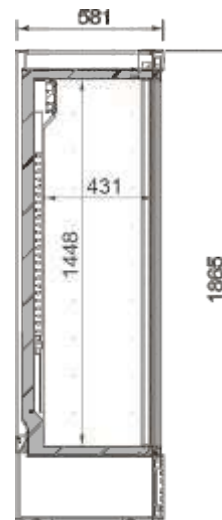

# Expositor refrigerado vertical / Glass door merchandiser / Armoire d'exposition réfrig. verticale

1

**NEW**



**NEW**



MODELO  
MODELE  
MODÈLE

ERC 50 PH

ERC 50 PH BT

ERC 130 PH

ERC 130 PH BT

ERC 200 PH

ERC 200 PH BT

Precio Price Prix						
Medidas Measures [mm] Mesures	687 x 842 x 2003 mm.		1384 x 842 x 2003 mm.		2081 x 842 x 2003 mm.	
Temperatura Temperature Température	+4°C/+8°C		-18°C		+4°C/+8°C	
Clase Climática Climatic class Classe climatique	4 / 38°C					
Tensión/Frecuencia Electrical data Tension électrique	230V/1ph/50Hz					
Controlador Controller Régulateur	Digital / Digital / Électronique IP65					
Material Material [EXT/INT] Matériel	Int acero plastificado blanco / Ext acero plastificado negro White plastic coated steel interior / Black plastic coated steel exterior Intérieur acier plastifié blanc / Extérieur acier plastifié noir					
Espesor Thickness Épaisseur	55					
Aislamiento Isolation Isolation	40kg/m <sup>3</sup> / Free CFC's / Zero ODP-GWP					
Capacidad Capacity Capacité	500		1310		2030	
Puertas Doors Portes	1		2		3	
Nº estantes Nº shelves Nº d'étagères	4		4		8	
Sistema de frío Cooling System Système de froid	Ventilado / Forced air / Ventilé					
Desescarche Defrost Dégivrage	Parada compresor / Compresor off / Arrêt compresseur.	Gas caliente / Hot gas / Gaz chaud	Parada compresor / Compresor off / Arrêt compresseur.	Gas caliente / Hot gas / Gaz chaud	Parada compresor / Compresor off / Arrêt compresseur.	Gas caliente / Hot gas / Gaz chaud
Expansión Expansion Expansion	Capilar / Capillary / Capillaire			Válvula termostática / Expansion valve / Détendeur thermostatique		
Potencia Power Puissance	414	662	844	890	1123	1960
Potencia frig. Cooling capacity Puissance Frig.	690	583	1296		1559	1484
Consumo Consumption Consommation	4,22	8,23	6,8	16,6	9,2	28
Clase energética Energy class Classe Énerg.	<b>C</b>		<b>C</b>		<b>D</b>	
Refrigerante Refrigerant Gaz	<b>R-290</b>					
Opcional Optional Options	<p>Iluminación Led RGB con cambio de color (por puerta) / Led lighting RGB change of colour (per door) / LED RGB avec changement de couleur (par porte)                      Kit Portaprecios ERC 100/130 (KPPER13)                      Kit Portaprecios ERC200 (KPPER20)                      115V/1 ph/60 Hz                      230V/1 ph/60 Hz                      Interior - Exterior / Interior - Exterior / Intérieur - extérieur</p> <div style="display: flex; justify-content: space-around; align-items: center;"> <div style="background-color: black; width: 20px; height: 20px; display: inline-block;"></div> Total Negro / Black / Noir RAL 9017                 </div> <div style="display: flex; justify-content: space-around; align-items: center;"> <div style="border: 1px solid black; width: 20px; height: 20px; display: inline-block;"></div> Total Blanco / White / Blanc RAL 9016                 </div>					

Serie / Series / Série **MINIMARKET**

+Info: [www.infrico.com](http://www.infrico.com)

ERC200PH



Controlador digital IP 65.  
Digital control IP65  
Contrôleur digital IP 65.

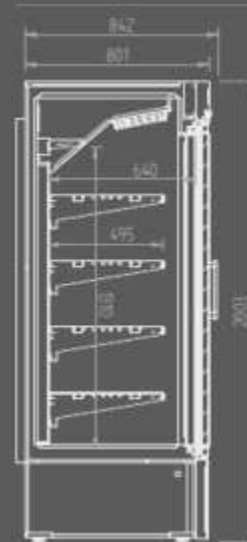

Video del producto  
Product Video  
Vidéo du produit



Infrico Youtube

**NEW**



ERC50PH



ERC130PH



ERC200PH BT

# Expositor de refrigeración y congelación / Glass door merchandiser refrigerator and freezer / Armoire d'exposition réfrigération et congélation

REFRIGERACIÓN / REFRIGERATOR / POSITIVE

CONGELACIÓN / FREEZER / NÉGATIVE



MODELO  
MODELE  
MODÈLE

NEC501RV

NEC1002RV

NEC401FS

NEC501FV

NEC1002FV

Precio Price Prix					
Medidas Measures [mm] Mesures	687 x 705 x 2010 mm.	1385 x 705 x 2010 mm.	687 x 670 x 2010 mm.	687 x 705 x 2010 mm.	1385 x 705 x 2010 mm.
Temperatura Temperature Température	<b>+2°C/+8°C</b>		<b>-15°C/-25°C</b>		
Clase Climática Climatic class Classe climatique	4 / 38°C				
Tensión/Frecuencia Electrical data Tension électrique	230V/1ph/50Hz				
Controlador Controller Régulateur	Digital / Digital / Électronique IP65				
Material Material [EXT/INT] Matériel	Ext/Int acero plastificado blanco / White plastic coated steel exterior/interior / Extérieur/Intérieur acier plastifié blanc				
Espesor Thickness Épaisseur	50				
Aislamiento Isolation Isolation	40kg/m <sup>3</sup> / Free CFC's / Zero ODP-GWP				
Capacidad Capacity Capacité	500	1000	430	500	1000
Puertas Doors Portes	1	2	1		2
N° parrillas / Guías N° shelves / Slides N° de grilles / Glissière	5 (530x460)	10 (530x510)	5 (438x556)	5 (530x460)	10 (530x510)
Sistema de frío Cooling System Système de froid	Forzado / Forced air / Ventilé		Estático / Static / Statique	Forzado / Forced air / Ventilé	
Desescarche Defrost Dégivrage	Parada de compresor / Compressor off / Arrêt du compresseur		Manual	Gas caliente / Hot gas defrost / Gaz chaud	
Expansión Expansion Expansion	Capilar / Capillary / Capillaire				Termostática / Thermostatic / Thermostatique
Potencia Power Puissance	414	445	487	662	826
Potencia frig. Cooling capacity Puissance Frig.	690		445	583	723
Consumo Consumption Consommation	4,22	5,05	-	8,23	16,61
Clase energética Energy class Classe Énerg.	<b>C</b>	<b>B</b>	-	<b>C</b>	<b>D</b>
Refrigerante Refrigerant Gaz	<b>R-290</b>				
Opcional Optional Options	Iluminación Led RGB con cambio de color (por puerta) / Led lighting RGB change of colour (per door) / LED RGB avec changement de couleur (par porte)				
	115V/1 ph/60 Hz 230V/1 ph/60 Hz		115V/1 ph/60 Hz 230V/1 ph/60 Hz		
	Exterior (Solo Puerta, Cuadro y Rejilla) / Exterior (door, control panel and grille) / extérieur (porte, bandeau et grille)				
	 Negro / Black / Noir RAL 9017				

Serie / Series / Série **NEC**

+Info: [www.infrico.com](http://www.infrico.com)

NEC1002FV



Controlador digital IP 65.  
Digital control IP65  
Contrôleur digital IP 65.



**Cabecal iluminado**  
Canopy illuminated  
Bandeau lumineux

**Triple acristalamiento templado, bajo emisivo con carga de Argón (4-12-3-12-4)**  
Triple tempered glass, low emission with Argon charge (4-12-3-12-4)  
Triple vitrage trempé à faible émissivité avec Argon (4-12-3-12-4)

NEC501FV

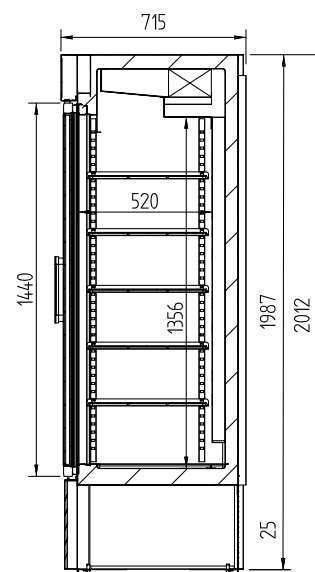

# Enfriador de botellas Supercooler / Chest bottle cooler Supercooler / Réfrigérateur de bouteilles Supercooler

1



SPC501



SPC501B

MODELO MODELE MODÈLE	SPC501	SPC501B
<b>Precio</b> Price Prix		
<b>Medidas</b> Measures [mm] Mesures	687 x 728 x 2003 mm.	687 x 728 x 2003 mm.
<b>Temperatura</b> Temperature [°C] Température	<b>+0°C/-8°C</b>	
<b>Clase Climática</b> Climatic class [°C] Classe climatique	4 / 38°C	
<b>Tensión/Frecuencia</b> Electrical data Tension électrique	230V/1ph/50Hz	
<b>Controlador</b> Controller Régulateur	Digital / Digital / Électronique IP65	
<b>Material</b> Material [EXT/INT] Matériel	Int: acero Inox AISI 430 / Ext: acero Inox AISI 304 Int: Stainless Steel AISI 430 / Ext: Stainless Steel AISI 304 Int: Stainless Steel AISI 430 / Ext: Acier Inox AISI 304	Int: acero Inox AISI 430 / Ext: Acero lacado negro Int: Stainless Steel AISI 430 / Ext: Black lacquered steel Int: Acier Inox AISI 430 / Ext: Acier laqué noir
<b>Espesor</b> Thickness [mm] Épaisseur	50	
<b>Aislamiento</b> Isolation [mm] Isolation	40kg/m <sup>3</sup> / Free CFC's / Zero ODP-GWP	
<b>Capacidad</b> Capacity [L] Capacité	500	
<b>Puertas</b> Doors Portes	1	
<b>Nº Estantes</b> Shelving Nº d' étagères	5 [560x480]	
<b>Sistema de frío</b> Cooling System Système de froid	Forzado / Forced air / Ventilé	
<b>Desescarche</b> Defrost Dégivrage	Gas caliente / Hot gas / Gaz chaud	
<b>Expansión</b> Expansion Expansion	Capilar / Capillary / Capillaire	
<b>Potencia</b> Power [W] Puissance	757	
<b>Potencia frig.</b> Cooling capacity [WA -10/-30°C] Puissance Frig.	650	
<b>Consumo</b> Consumption [kWh/ 24h] Consommation	-	
<b>Clase energética</b> Energy class Classe Énerg.	-	
<b>Refrigerante</b> Refrigerant Gaz	<b>R-290</b>	
<b>Opcional</b> Optional Options	Parrilla / Wire shelf / Grille métallique [502x119]  115V/1 ph/60 Hz 230V/1 ph/60 Hz	



Serie / Series / Série **SPC**

+Info: [www.infrico.com](http://www.infrico.com)



SPC501



Bebida en estado líquido sin congelar.



Temperatura bajo cero en menos de 2h.



Tecnología aplicable a todo tipo de bebidas



SPC501B



SPC501

Triple acristalamiento templado, bajo emisor con carga de Argón (4-12-3-12-4)  
 Triple tempered glass, low emission with Argon charge (4-12-3-12-4)  
 Triple vitrage trempé à faible émissivité avec Argon (4-12-3-12-4)

Grado de alcohol Alcoholic strength Teneur en alcool	Punto de corte Set point Point de coupure
5% < 5,5%	-7°
4% < 5%	-6°
3,5% < 4%	-5°
Cerveza/Beer/Bière 0,0%	-2°
Refrescos carbonatados/ Carbonated beverages Boissons gazeuses (non alcoolisées)	-2°

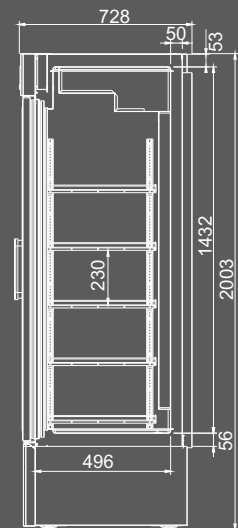

# Escarchador de copas / Glass froster counter / Mini congélateur verticale

# Tanque enfriador de agua / Water tank cooler / Refrigidisseurs d'eau

CONGELACIÓN / FREEZER / NÉGATIF

REFRIGERACIÓN / REFRIGERATOR / POSITIF

MODELO  
MODELE  
MODÈLE



ESC 50



ESC 50 CR



TA 100 II



TA 180 II

MODELO MODELE MODÈLE	ESC 50	ESC 50 CR	TA 100 II	TA 180 II
<b>Precio</b> Price Prix				
<b>Medidas</b> Measures [mm] Mesures	570 x 600 x 850 mm.	570 x 600 x 850 mm.	1312 x 562 x 570 mm.	902 x 562 x 1133 mm.
<b>Temperatura</b> Temperature Température	-5°C/-18°C	-5°C/-10°C	+1°C/+4°C	
<b>Clase Climática</b> Climatic class Classe climatique	4 / 38°C			
<b>Tensión/Frecuencia</b> Electrical data Tension électrique	230V/1ph/50Hz			
<b>Controlador</b> Controller Régulateur	Digital / Digital / Électronique IP65			
<b>Material</b> Material [EXT/INT] Matériel	AISI 304			
<b>Espesor</b> Thickness Épaisseur	60			
<b>Aislamiento</b> Isolation Isolation	40kg/m <sup>3</sup> / Free CFC's / Zero ODP-GWP			
<b>Capacidad</b> Capacity Capacité	95	95	100	180
<b>Puertas</b> Doors Portes	1	1	-	
<b>Nº parrillas / Guías</b> Nº shelves / Slides Nº de grilles / Glissière	2 (400 x 430)	2 (400 x 430)	-	
<b>Sistema de frío</b> Cooling System Système de froid	Condensación Forzada / Forced air condensation / Condensation Ventilé Evaporador estático / Static evaporator / Évaporateur statique		Forzado / Forced air / Ventilé	
<b>Desescarche</b> Defrost Dégivrage	-			
<b>Expansión</b> Expansion Expansion	Capilar / Capillary / Capillaire			
<b>Potencia</b> Power Puissance	315	323	555	647
<b>Potencia frig.</b> Cooling capacity Puissance Frig.	306	306	1041	1296
<b>Consumo</b> Consumption Consommation	-			
<b>Clase energética</b> Energy class Classe Énerg.	-			
<b>Refrigerante</b> Refrigerant Gaz	R-290			
<b>Opcional</b> Optional Options	Juego de guías / Slides / Jeu de Glissières (503X11) Parrilla / Wire shelf / Grille (502X45)		Soporte enfriador / Wall hangers / Support (STA) KIT Filtro agua / Water filter / Filtre à eau (4600x0018)	
	115V/1 ph/60 Hz 230V/1 ph/60 Hz		115V/1 ph/60 Hz 230V/1 ph/60 Hz	

Serie / Series / Série **ESC / TA**

+Info: [www.infrico.com](http://www.infrico.com)

ESC 50



ESC 50 CR

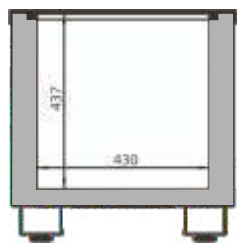

**Opción Kit filtro de agua**  
Option Kit water filter  
Optionel Kit filtre à eau



**Serpentín interior en Acero Inoxidable**  
Stainless Steel interior coil  
Serpentin intérieur en Acier Inoxydable

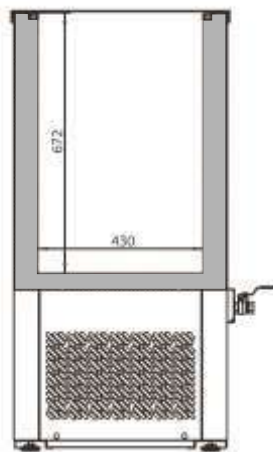

TA 100 II



TA 180 II



+Info: [www.infrico.com](http://www.infrico.com)



# Mesas

Tables / Tables

2





Infrico

40

Serie / Series / Série

# 600



BMPP II  
BMPP BT  
BMPP CR  
BMPP F II  
BMPP GR  
BMPP GR BT  
BMPP EN \_\_\_\_\_ 60-65

**NEW**

Serie / Series / Série

# MSG/MPG



MSG  
MSG BT \_\_\_\_\_ 66-67

**NEW**

Serie / Series / Série

# 700GN1/1



BMGN A+  
BMGN II  
BMGN BT  
BMGN CR  
BMGN F II  
BMGN GR  
BMGN GR BT  
BMGN EN  
BMGN PDC \_\_\_\_\_ 68-77

Serie / Series / Série

# ME



MPG  
ME VIP  
ME BAN  
ME EN  
ME II  
ME PIZZA  
ME KB \_\_\_\_\_ 76-81

**NEW**

Serie / Series / Série

# BARSTATION



BST \_\_\_\_\_ 82-83

Serie / Series / Série

# 800MR



MR  
MR BT  
MR CR  
MR GR  
MR PDC  
MR PD CR  
MR EN  
MR H \_\_\_\_\_ 84-91

Serie / Series / Série

# 800MPL/MP



MPL  
MP  
MP CN \_\_\_\_\_ 92-93

Serie / Series / Série

# FMPP



FMPP II  
FMPP CR  
FMPP GR \_\_\_\_\_ 94-95

Serie / Series / Série

# MCAF/ME/MT



MCAF  
MCAF CD  
MCAF CI  
ME 30  
ME 60  
MT 60  
MT 70 \_\_\_\_\_ 96-97



+Info: [www.infrico.com](http://www.infrico.com)



## 2. Mesas Undercounters / Tables

Nuevo controlador digital táctil e intuitivo IP 65.

New digital control easy and intuitive-touch screen IP65 protection.

Nouveau contrôleur digital tactile e intuitif IP 65.



Encimera reforzada con Omegas de serie [series 600/700].

Reinforced worktop with Omegas as standard [600/700 series].

Plan de travail renforcé avec Omegas en standard [séries 600/700].



Doble acristalamiento templado, bajo emisivo con carga de Argón [4-27-4].

Double tempered glass, low-e with argon charge [4-27-4].

Double vitrage et verre trempé [4-12-3-12-4].



Encimera con fregadero opcional [BMPP F - BMGN F]

Worktop with optional sink [BMPP F - BMGN F]

Plan de travail avec évier optionnel [BMPP F - BMGN F]



Opcional: Manejo del control digital por WiFi o Bluetooth®

Optional: Operating digital control by WiFi or Bluetooth®

Optionnel: Fonctionnement de la commande numérique par WiFi ou Bluetooth®

### Iluminación / Lighting / Éclairage

Incorporación de iluminación LED, llegando a reducir el consumo energético entre un 80% y 90%, respecto a una bombilla tradicional. RGB opcional.

LED lighting incorporated, reducing energetic consumption between 80% and 90% respect to a traditional light bulb. RGB optional.

Éclairage LED, réduisant la consommation énergétique entre 80% et 90%, par rapport à une ampoule traditionnelle. RGB optionnel.



+Info: [www.infrico.com](http://www.infrico.com)



Puertas con tirador de doble agarre y burlete plano desmontable "cleanless".

Double handle doors and flat gasket easily removable "cleanless".

Portes avec double poignée et joint plat facilement démontable "cleanless".

Kit cajones / Drawers kit / Kit tiroirs

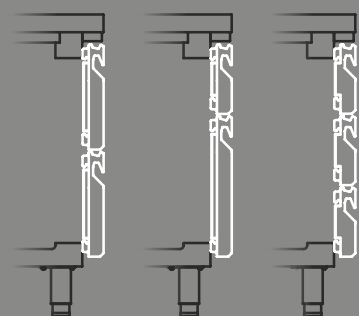

Nuevas guías Fulterer para cajones.

New Fulterer draw slides.

Nouveau glissières Fulterer pour tiroirs.

 70kg  
 -25°C



Refrigeración / Refrigeration / Réfrigération

Sistemas de frío ventilado. Bandejas evaporativas sin resistencia eléctrica para una mayor eficiencia energética. Sistemas de evaporación forzada. Evaporadores tratados con Epoxi de poliéster anticorrosión. Unidades sobredimensionadas y eficientes. Válvulas de expansión termostáticas y desescarches por gas caliente en baja temperatura. Marcos de puerta calefactados para evitar acumulación de hielo.

Forced air cooling systems. Energy-saving non-electric condensate pans. Forced evaporation systems. Evaporators treated with anti-corrosion polyester Epoxy. Oversized and efficient units. Expansion valves. Hot gas defrost. Heating door frames to prevent ice build-up.

Systèmes de froid ventilé. Bacs d'évaporation sans résistances électriques pour une meilleure efficacité énergétique. Systèmes d'évaporation forcé. Évaporateurs traités avec un epoxy polyester anticorrosion. Unités efficaces et surdimensionnées. Valves d'expansion thermostatiques. Dégivrache par gaz chaud. Cadres de portes chauffés pour empêcher l'accumulation de glace.



# Mesa de refrigeración y congelación / Undercounter refrigerator and freezer / Desserte dessus de comptoir positive et négative

MODELO  
MODELE  
MODÈLE



BMPP 1500 II



BMPP 2000 II



BMPP 2500 II



BMPP 1500 BT



BMPP 2000 BT



BMPP 2500 BT

Precio Price Prix							
Medidas Measures [mm] Mesures	↔ ↕	1468 x 600 x 850 mm.	1960 x 600 x 850 mm.	2452 x 600 x 850 mm.	1468 x 600 x 850 mm.	1960 x 600 x 850 mm.	2452 x 600 x 850 mm.
Temperatura Temperature Température	[°C]	-2°C/+8°C			-18°C		
Clase Climática Climatic class Classe climatique	[°C]	5 / 40° C			4 / 38°C		
Tensión/Frecuencia Electrical data Tension électrique		230V/1ph/50Hz					
Controlador Controller Régulateur		Digital IP65					
Material Material [EXT/INT] Matériel		AISI 304					
Espesor Thickness Épaisseur	[mm]	70					
Aislamiento Isolation Isolation	[mm]	40kg/m <sup>3</sup> / Free CFC's / Zero ODP-GWP					
Capacidad Capacity Capacité	[L]	250	385	510	250	385	510
Puertas Doors Portes		2	3	4	2	3	4
Nº parrillas / Guías Nº shelves / Slides Nº de grilles / Glissière		2/2 [325x430]	3/3 [325x430]	4/4 [325x430]	2/2 [325x430]	3/3 [325x430]	4/4 [325x430]
Sistema de frío Cooling System Système de froid		Monoblock ventilado / Forced air monoblock / Monoblock ventilé					
Desescarche Defrost Dégivrage		Parada compresor / Compressor off / Arrêt du compresseur			Gas caliente / Hot gas / Gaz chaud		
Expansión Expansion Expansion		Capilar / Capillary / Capillaire			Válvula termostática / Expansion valve / Détendeur thermostatique		
Potencia Power Puissance	[W]	260	260	446	443	472	561
Potencia frig. Cooling capacity Puissance Frig.	[WA -10/-30°C]	370	370	690	445	445	540
Consumo Consumption Consommation	[kWh/ 24h]	1,55	1,80	2,05	4,02	6,57	6,78
Clase energética Energy class Classe Énerg.		<b>A</b>			<b>C</b>	<b>D</b>	<b>C</b>
Refrigerante Refrigerant Gaz		<b>R-290</b>					
Opcional Optional Options		115V/1ph/60Hz 230V/1ph/60Hz			115V/1ph/60Hz 230V/1ph/60Hz		
		Parrilla / Wire shelf / Grille [502X07] Cerradura / Lock / Serrure [506X209; 506X210] Juego de guías / Slides / Jeu de Glissières [GUIACO115430, GUIACO215430] Grupo lado contrario / Group opposite side / Groupe opposé [L]			Ruedas / Casters / Roulettes [705X16=2; 705X17=2] Sin peto trasero / Without backsplash / Sans dossier		
		Kit cajones / Drawer Kit / Kit tiroirs BM 1/2 x 200 [JCAJ17BM1/2] BM 1/3 x 100 [JCAJ17BM1/3] BM 2/3 + BM 1/3 [JCAJ17BM2/3]					

Serie / Series / Série **600**

+Info: [www.infrico.com](http://www.infrico.com)

BMPP 2000 II



**Controlador digital IP 65.**  
Digital control IP65  
Contrôleur digital IP 65.





**Opcional: Manejo control digital por WiFi o Bluetooth\***  
Optional: Operating digital control by WiFi or Bluetooth\*

**Circulación optimizada del aire**  
Optimal air flow  
Circulation d'air optimisée



**Sistema de ventilación de condensación frontal**  
Front breathing condensation system  
Système de ventilation à condensation frontale



**Refuerzo con Omegas.**  
Omega reinforcement.  
Renforcement avec Omegas.



**Kit 2 cajones**  
2 drawers kit  
Kit 2 tiroirs

BM 1/2 x 200



**Kit 2 cajones**  
2 drawers kit  
Kit 2 tiroirs

BM 2/3x300 +  
BM 1/3x100



**Kit 3 cajones**  
3 drawers kit  
Kit 3 tiroirs

BM 1/3x100



**1/2**  
302 x 418 x 205

**2/3**  
302 x 418 x 307

**1/3**  
302 x 418 x 105









**KIT CAJONES / DRAWERS KIT / KIT TIROIRS (MOD. II)**

**Mesa refrigerada puertas cristal /**  
**Glass Door undercounter refrigerator /**  
 Desserte dessus de comptoir posit. portes vitrées

**Mesa refrigerada con fregadero /**  
**Sink undercounter refrigerator /**  
 Desserte dessus de comptoir posit. avec évier



F= Fregadero / Sink / Evier

MODELO MODELE MODÈLE						
Precio Price Prix						
Medidas Measures [mm] Mesures	1468 x 600 x 850 mm.	1960 x 600 x 850 mm.	2452 x 600 x 850 mm.	1468 x 600 x 850 mm.	1960 x 600 x 850 mm.	2452 x 600 x 850 mm.
Temperatura Temperature Température	+2°C/+6°C			-2°C/+8°C		
Clase Climática Climatic class Classe climatique	4 / 38°C			5 / 40°C		
Tensión/Frecuencia Electrical data Tension électrique	230V/1ph/50Hz					
Controlador Controller Régulateur	Digital IP65					
Material Material [EXT/INT] Matériel	AISI 304					
Espesor Thickness Épaisseur	70					
Aislamiento Isolation Isolation	40kg/m <sup>3</sup> / Free CFC's / Zero ODP-GWP					
Capacidad Capacity Capacité	250	385	510	250	385	510
Puertas Doors Portes	2	3	4	2	3	4
Nº parrillas / Guías Nº shelves / Slides Nº de grilles / Glissière	2/2 [325x430]	3/3 [325x430]	4/4 [325x430]	2/2 [325x430]	3/3 [325x430]	4/4 [325x430]
Sistema de frío Cooling System Système de froid	Monoblock ventilado / Forced air monoblock / Monoblock ventilé					
Desescarche Defrost Dégivrage	Parada compresor / Compressor off / Arrêt du compresseur					
Expansión Expansion Expansion	Capilar / Capillary / Capillaire					
Potencia Power Puissance	270	382	387	260	260	446
Potencia frig. Cooling capacity Puissance Frig.	370	690	690	370	370	690
Consumo Consumption Consommation	-	-	-	1,55	1,80	2,05
Clase energética Energy class Classe Énerg.	-			A	A	A
Refrigerante Refrigerant Gaz	R-290					
Opcional Optional Options	Juego de guías / Slides / Jeu de Glissières [GUIAC0115430, GUIAC0215430] Grupo lado contrario / Group opposite side / Groupe opposé [L] 115V/1ph/60Hz 230V/1ph/60Hz Kit cajones / Drawer Kit / Kit tiroirs BM 1/2 x 200 [JCAJ17BM1/2] BM 1/3 x 100 [JCAJ17BM1/3] BM 2/3 + BM 1/3 [JCAJ17BM2/3]					
	Parrilla / Wire shelf / Grille [502X43] Cerradura / Lock / Serrure [506X60] Iluminación Led RGB con cambio de color (por puerta) / Led lighting RGB change of colour (per door) / LED RGB avec changement de couleur (par porte)			Parrilla / Wire shelf / Grille [502X07] Cerradura / Lock / Serrure [506X209; 506X210]		

Serie / Series / Série **600**

+Info: [www.infrico.com](http://www.infrico.com)

**Doble cristal templado bajo emisivo más carga Argón 4-27-4**  
 Double tempered glass low-e + Argón 4-27-4  
 Double vitrage trempé à faible émissivité avec<sup>o</sup>

**BMPP 1500 CR**

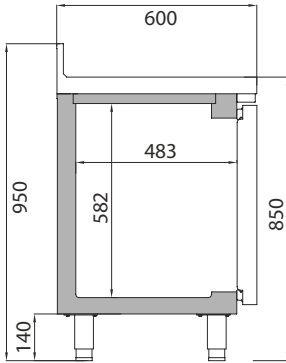

**F= Fregadero / Sin**  
**BMPPF 15**



**Opcional**  
 Optional  
 Option

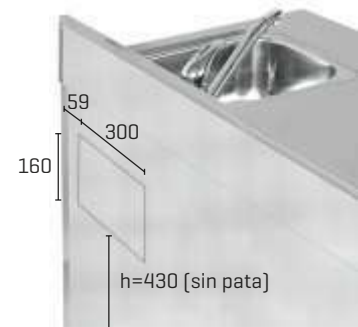

**Kit 2 cajones**  
 2 drawers kit  
 Kit 2 tiroirs

BM 1/2 x 200

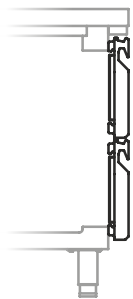

**Kit 2 cajones**  
 2 drawers kit  
 Kit 2 tiroirs

BM 2/3x300 +  
 BM 1/3x100

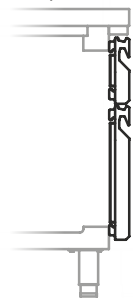

**Kit 3 cajones**  
 3 drawers kit  
 Kit 3 tiroirs

BM 1/3x100

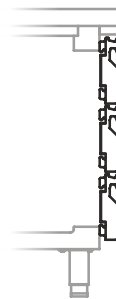

**1/2**      **2/3**      **1/3**  
**302 x 418 x 205**      **302 x 418 x 307**      **302 x 418 x 105**



**KIT CAJONES / DRAWERS KIT / KIT TIROIRS (MOD. CR)**

**Mesa refrigerada pre-instalada /**  
**Remote undercounter refrigerator /**  
 Desserte dessus de comptoir groupe à distance

**Mesa refrigerada ensaladas /**  
**Salad prep refrigerator undercounter /**  
 Desserte dessus de comptoir posit. prép. salades



Ensaladas / Salad prep / Prép. salades



MODELO  
 MODÈLE  
 MODÈLE

BMPP 1500 GR

BMPP 2000 GR

BMPP 1500 GRBT

BMPP 2000 GRBT

BMPP 1500 EN

BMPP 2000 EN

Precio Price Prix						
Medidas Measures [mm] Mesures	1240 x 600 x 850 mm.	1732 x 600 x 850 mm.	1240 x 600 x 850 mm.	1732 x 600 x 850 mm.	1468 x 600 x 1100 mm.	1960 x 600 x 1100 mm.
Temperatura Temperature Température	0°C/+6°C		-18°C		0°C/+6°C	
Clase Climática Climatic class Classe climatique			-		4 / 38°C	
Tensión/Frecuencia Electrical data Tension électrique	230V/1ph/50Hz					
Controlador Controller Régulateur	Digital IP65					
Material Material [EXT/INT] Matériel	AISI 304					
Espesor Thickness Épaisseur	70					
Aislamiento Isolation Isolation	40kg/m <sup>3</sup> / Free CFC's / Zero ODP-GWP					
Capacidad Capacity Capacité	250	385	250	385	250+50	385+70
Puertas Doors Portes	2	3	2	3	2	3
Nº parrillas / Guías Nº shelves / Slides Nº de grilles / Glissière	2/2 [325x430]	3/3 [325x430]	2/2 [325x430]	3/3 [325x430]	2/2 [325x430]	3/3 [325x430]
Sistema de frío Cooling System Système de froid	Monoblock ventilado / Forced air monoblock / Monoblock ventilé					
Desescarche Defrost Dégivrage	Parada compresor / Compressor off / Arrêt du compresseur		Gas caliente / Hot gas / Gaz chaud		Parada compresor / Compressor off / Arrêt du compresseur	
Expansión Expansion Expansion	Opcional / Optional / Options				Capilar / Capillary / Capillaire	
Potencia Power Puissance			-		249	249
Potencia frig. Cooling capacity Puissance Frig.	Recom. 370	Recom. 370	Recom. 445	Recom. 445	370	370
Consumo Consumption Consommation	-					
Clase energética Energy class Classe Énerg.	-					
Refrigerante Refrigerant Gaz	-				R-290	
Opcional Optional Options	Juego de guías / Slides / Jeu de Glissières [GUIAC0115430, GUIAC0215430] Cerradura / Lock / Serrure [506X209; 506X210] Parrilla / Wire shelf / Grille [502X07]					
	Válvula expansión [especificar refrigerante] / Expansion valve [specify refrigerant] / Détendeur [spécifier le gaz] Puerta de cristal [unidad] / Glass door [unit] / Porte vitrée [unité] [PUE17IDGN-PUE17IIGN][GR]				Ruedas / Casters / Roulettes [705X16=2; 705X17=2] BMPP 1500 EN [501X16] = 8 BMPP 2000 EN [501X16] = 11	
	Kit cajones / Drawer Kit / Kit tiroirs BM 1/2 x 200 [JCAJ17BM1/2] BM 1/3 x 100 [JCAJ17BM1/3] BM 2/3 + BM 1/3 [JCAJ17BM2/3]		Kit cajones / Drawer Kit / Kit tiroirs Consultar / On request / À la demande 115V/1ph/60Hz 230V/1ph/60Hz		Kit cajones / Drawer Kit / Kit tiroirs BM 1/2 x 200 [JCAJ17BM1/2] BM 1/3 x 100 [JCAJ17BM1/3] BM 2/3 + BM 1/3 [JCAJ17BM2/3]	



Serie / Series / Série **600**

+Info: [www.infrico.com](http://www.infrico.com)

**Video del producto**

Product Video

Vidéo du produit



Infrico Youtube



Refuerzo con Omegas.  
Omega reinforcement.  
Renforcement avec Omegas.



**Posibilidad de acceso frontal y lateral para una mejor manipulación.**  
Front and lateral access for better handling  
Possibilité d'accès frontal et latéral pour une meilleure manipulation.



Refrigeración estática en la cuba  
Static cooling in the tank  
Refroidissement statique supérieur



BMPP 2000 EN

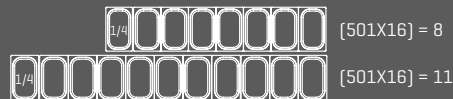

**Kit 2 cajones**  
2 drawers kit  
Kit 2 tiroirs

BM 1/2 x 200



**Kit 2 cajones**  
2 drawers kit  
Kit 2 tiroirs

BM 2/3x300 +  
BM 1/3x100



**Kit 3 cajones**  
3 drawers kit  
Kit 3 tiroirs

BM 1/3x100



1/2  
302 x 418 x 205

2/3  
302 x 418 x 307

1/3  
302 x 418 x 105



**KIT CAJONES / DRAWERS KIT / KIT TIROIRS (MOD. GR - EN)**

# Mesa baja refrigeración y congelación / Counter bases refrigerator and freezer / Soubassement gastronorme positif et negative



MODELO MODELE MODÈLE									
	MSG 1000	MSG 1400	MSG 1600	MSG 2000	MSG 2400	MSG 1000 BT	MSG 1400 BT	MSG 1600 BT	MSG 2000 BT
<b>Precio</b> Price Prix									
<b>Medidas</b> Measures [mm] Mesures	1000 x 700 x 650 mm.	1400 x 700 x 650 mm.	1600 x 700 x 650 mm.	2000 x 700 x 650 mm.	2400 x 700 x 650 mm.	1000 x 700 x 650 mm.	1400 x 700 x 650 mm.	1600 x 700 x 650 mm.	2000 x 700 x 650 mm.
<b>Temperatura</b> Temperature Température	<b>-2°C/+8°C</b>					<b>-18°C</b>			
<b>Clase Climática</b> Climatic class Classe climatique	5 / 40°C					4 / 38°C			
<b>Tensión/Frecuencia</b> Electrical data Tension électrique	230V/1ph/50Hz								
<b>Controlador</b> Controller Régulateur	Digital IP65								
<b>Material</b> Material [EXT/INT] Matériel	AISI 304								
<b>Espesor</b> Thickness Épaisseur	70								
<b>Aislamiento</b> Isolation Isolation	40kg/m <sup>3</sup> / Free CFC's / Zero ODP-GWP								
<b>Capacidad</b> Capacity Capacité	100	190	225	310	435	100	190	225	310
<b>Cajones</b> Drawers Tiroirs	2	4	4	6	8	2	4	4	6
<b>Nº parrillas / Guías</b> Nº shelves / Slides Nº de grilles / Glissière	-								
<b>Sistema de frío</b> Cooling System Système de froid	Monoblock ventilado / Forced air monoblock / Monoblock ventilé								
<b>Desescarche</b> Defrost Dégivrage	Parada compresor / Compressor off / Arrêt du compresseur					Gas caliente / Hot gas defrost / Gaz chaud			
<b>Expansión</b> Expansion Expansion	Capilar / Capillary / Capillaire					Válvula de expansión termostática / Thermostatic expansion valve / Détendeur thermostatique			
<b>Potencia</b> Power Puissance	205	210			368	443	443	472	561
<b>Potencia frig.</b> Cooling capacity Puissance Frig.	370				690	445	445	540	540
<b>Consumo</b> Consumption Consommation	0,98	1,23	1,33	1,61	1,77	4,02	4,02	6,57	6,78
<b>Clase energética</b> Energy class Classe Énerg.	<b>A</b>	<b>A</b>	<b>A</b>	<b>B</b>	<b>B</b>	<b>C</b>	<b>C</b>	<b>D</b>	<b>D</b>
<b>Refrigerante</b> Refrigerant Gaz	<b>R-290</b>								
<b>Opcional</b> Optional Options	Cerradura / Lock / Serrure [506X209; 506X210] Puerta [unidad] / Door [unit] / Porte [unité] [PUE17ISN] Cajón / Drawer / Tiroir 2/3x300 [JCAJ17SN2/3] <b>Sin incremento / Without supplement / Sans supplément</b>								
	115V/1ph/60Hz 230V/1ph/60Hz					115V/1ph/60Hz 230V/1ph/60Hz			

**NEW**

Serie / Series / Série **MSG GN1/1 700**

+Info: [www.infrico.com](http://www.infrico.com)

### MSG 2000



Refuerzo con Omegas.  
Omega reinforcement.  
Renforcement avec Omegas.



Controlador digital IP 65.  
Digital control IP65  
Contrôleur digital IP 65.



Opcional: Manejo control digital por WiFi o Bluetooth\*

Optional: Operating digital control by WiFi or Bluetooth\*

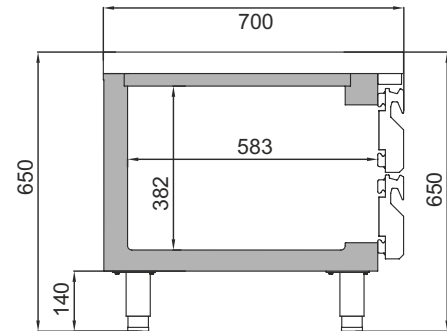

### MSG 1600

Puertas opcionales  
Optionals doors  
Portes en option



# Mesa refrigeración y congelación / Undercounter refrigerator and freezer / Desserte gastronomique positive et négative

MODELO  
MODELE  
MODÈLE



**BMGN 1470 II**

**BMGN 1960 II**

**BMGN 2450 II**

**BMGN 1470 BT**

**BMGN 1960 BT**

**BMGN 2450 BT**

<b>Precio</b> Price Prix						
<b>Medidas</b> Measures [mm] Mesures	1468 x 700 x 850 mm.	1960 x 700 x 850 mm.	2452 x 700 x 850 mm.	1468 x 700 x 850 mm.	1960 x 700 x 850 mm.	2452 x 700 x 850 mm.
<b>Temperatura</b> Temperature Température	<b>-2°C/+8°C</b>			<b>-18°C</b>		
<b>Clase Climática</b> Climatic class Classe climatique	5 / 40°C			4 / 38°C		
<b>Tensión/Frecuencia</b> Electrical data Tension électrique	230V/1ph/50Hz					
<b>Controlador</b> Controller Régulateur	Digital IP65					
<b>Material</b> Material [EXT/INT] Matériel	AISI 304					
<b>Espesor</b> Thickness Épaisseur	70					
<b>Aislamiento</b> Isolation Isolation	40kg/m <sup>3</sup> / Free CFC's / Zero ODP-GWP					
<b>Capacidad</b> Capacity Capacité	305	465	630	305	465	630
<b>Puertas</b> Doors Portes	2	3	4	2	3	4
<b>Nº parrillas / Guías</b> Nº shelves / Slides Nº de grilles / Glissière	2/10 {325x530}	3/15 {325x530}	4/20 {325x530}	2/10 {325x530}	3/15 {325x530}	4/20 {325x530}
<b>Sistema de frío</b> Cooling System Système de froid	Monoblock ventilado / Forced air monoblock / Monoblock ventilé					
<b>Desescarche</b> Defrost Dégivrage	Parada compresor / Compressor off / Arrêt du compresseur			Gas caliente / Hot gas defrost / Gaz chaud		
<b>Expansión</b> Expansion Expansion	Capilar / Capillary / Capillaire			Válvula de expansión termostática / Thermostatic expansion valve / Détendeur thermostatique		
<b>Potencia</b> Power Puissance	210	368		508	597	711
<b>Potencia frig.</b> Cooling capacity Puissance Frig.	570	690		445	540	640
<b>Consumo</b> Consumption Consommation	1,50	1,95	2,25	5,45	7,71	9,03
<b>Clase energética</b> Energy class Classe Énerg.	<b>A</b>			<b>C</b>	<b>D</b>	<b>D</b>
<b>Refrigerante</b> Refrigerant Gaz	<b>R-290</b>					
<b>Opcional</b> Optional Options	Sin peto trasero / Without backsplash / Sans dosseret Parrilla / Wire shelf / Grille [502X12] Juego de guías / Slides / Jeu de Glissières [GUIAC0115530, GUIAC0215530] Cerradura / Lock / Serrure [506X209; 506X210] Grupo lado contrario / Group opposite side / Groupe opposé [L]			Ruedas / Casters / Roulettes [705X16=2; 705X17=2]		
	Kit cajones / Drawer Kit / Kit tiroirs BMGN 1/2 x 200 [JCAJ176N1/2] BMGN 1/3 x 100 [JCAJ176N1/3] BMGN 2/3 + BMGN 1/3 [JCAJ176N2/3]			115V/1ph/60Hz 230V/1ph/60Hz		

Serie / Series / Série **GN1/1 700**

+Info: [www.infrico.com](http://www.infrico.com)

**BMGN 1470 II**



Refuerzo con Omegas.  
Omega reinforcement.  
Renforcement avec Omegas.

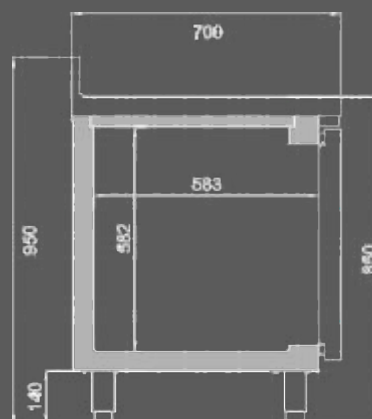

**Kit 2 cajones**  
2 drawers kit  
Kit 2 tiroirs

BM 1/2 x 200



**Kit 2 cajones**  
2 drawers kit  
Kit 2 tiroirs

BM 2/3x300 +  
BM 1/3x100



**Kit 3 cajones**  
3 drawers kit  
Kit 3 tiroirs

BM 1/3x100

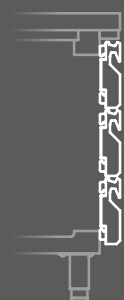

**1/2**  
302 x 518 x 205

**2/3**  
302 x 518 x 307

**1/3**  
302 x 518 x 105



**KIT CAJONES / DRAWERS KIT / KIT TIROIRS (MOD. II)**

# Mesa refrigeración y congelación / Undercounter refrigerator and freezer / Desserte gastronomique positive et négative

MODELO  
MODELE  
MODÈLE

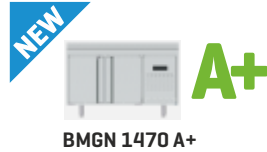

	BMGN 1470 A+	BMGN 1960 A+
<b>Precio</b> Price Prix		
<b>Medidas</b> Measures [mm] Mesures	1468 x 700 x 850 mm.	1960 x 700 x 850 mm.
<b>Temperatura</b> Temperature [°C] Température	<b>-2°C/+8°C</b>	
<b>Clase Climática</b> Climatic class [°C] Classe climatique	5 / 40°C	
<b>Tensión/Frecuencia</b> Electrical data Tension électrique	230V/1ph/50Hz	
<b>Controlador</b> Controller Régulateur	Digital IP65	
<b>Material</b> Material [EXT/INT] Matériel	AISI 304	
<b>Espesor</b> Thickness [mm] Épaisseur	70	
<b>Aislamiento</b> Isolation [mm] Isolation	40kg/m <sup>3</sup> / Free CFC's / Zero ODP-GWP	
<b>Capacidad</b> Capacity [L] Capacité	305	465
<b>Puertas</b> Doors Portes	2	3
<b>N° parrillas / Guías</b> N° shelves / Slides N° de grilles / Glissière	2/10 [325x530]	3/15 [325x530]
<b>Sistema de frío</b> Cooling System Système de froid	Monoblock ventilado / Forced air monoblock / Monoblock ventilé	
<b>Desescarche</b> Defrost Dégivrage	Parada compresor / Compressor off / Arrêt du compresseur	
<b>Expansión</b> Expansion Expansion	Capilar / Capillary / Capillaire	
<b>Potencia</b> Power [W] Puissance	210	368
<b>Potencia frig.</b> Cooling capacity [W A -10°C] Puissance Frig.	570	690
<b>Consumo</b> Consumption [kWh/ 24h] Consommation	0,82	1,01
<b>Clase energética</b> Energy class Classe Énerg.	<b>A+</b>	
<b>Refrigerante</b> Refrigerant Gaz	<b>R-290</b>	
<b>Opcional</b> Optional Options	Sin peto trasero / Without backsplash / Sans dossieret Parrilla / Wire shelf / Grille [502X12] Juego de guías / Slides / Jeu de Glissières [GUIAC0115530, GUIAC0215530] Cerradura / Lock / Serrure [506X209; 506X210] Grupo lado contrario / Group opposite side / Groupe opposé [L] 115V/1ph/60Hz 230V/1ph/60Hz Ruedas / Casters / Roulettes [705X16=2; 705X17=2]	

**NEW**

Serie / Series / Série **GN1/1 700**

+Info: [www.infrico.com](http://www.infrico.com)

Clase energ.  
Energy class  
Classe Énerg.

# A+

## INVERTER

BMGN 1960 A+



Refuerzo con Omegas.  
Omega reinforcement.  
Renforcement avec Omegas.









**Mesa refrigerada puertas cristal /**  
**Glass Door undercounter refrigerator /**  
 Desserte dessus de comptoir posit. portes vitrées

**Mesa refrigerada con fregadero /**  
**Sink undercounter refrigerator /**  
 Desserte dessus de comptoir posit. avec évier



F= Fregadero / Sink / Evier

MODELO MODELE MODÈLE						
	BMGN 1470 CR	BMGN 1960 CR	BMGN 2450 CR	BMGN 1470 F	BMGN 1960 F	BMGN 2450 F
Precio Price Prix						
Medidas Measures [mm] Mesures	1468 x 700 x 850 mm.	1960 x 700 x 850 mm.	2452 x 700 x 850 mm.	1468 x 700 x 850 mm.	1960 x 700 x 850 mm.	2452 x 700 x 850 mm.
Temperatura Temperature Température	+2°C/+6°C			-2°C/+8°C		
Clase Climática Climatic class Classe climatique	4 / 38°C			5 / 40°C		
Tensión/Frecuencia Electrical data Tension électrique	230V/1ph/50Hz					
Controlador Controller Régulateur	Digital IP65					
Material Material [EXT/INT] Matériel	AISI 304					
Espesor Thickness Épaisseur	70					
Aislamiento Isolation Isolation	40kg/m <sup>3</sup> / Free CFC's / Zero ODP-GWP					
Capacidad Capacity Capacité	305	465	630	305	465	630
Puertas Doors Portes	2	3	4	2	3	4
Nº parrillas / Guías Nº shelves / Slides Nº de grilles / Glissière	2/10 [325x530]	3/15 [325x530]	4/20 [325x530]	2/10 [325x530]	3/15 [325x530]	4/20 [325x530]
Sistema de frío Cooling System Système de froid	Monoblock ventilado / Forced air monoblock / Monoblock ventilé					
Desescarche Defrost Dégivrage	Parada compresor / Compressor off / Arrêt du compresseur					
Expansión Expansion Expansion	Capilar / Capillary / Capillaire					
Potencia Power Puissance	377	382	387	210	368	
Potencia frig. Cooling capacity Puissance Frig.	690	690	690	370	690	
Consumo Consumption Consommation		-		1,50	1,95	2,25
Clase energética Energy class Classe Énerg.		-		<b>A</b>	<b>A</b>	<b>A</b>
Refrigerante Refrigerant Gaz	<b>R-290</b>					
Opcional Optional Options	Juego de guías / Slides / Jeu de Glissières [GUIAC0115530, GUIAC0215530]					
	Parrilla doble tupida / Extradense wire shelf / Grille renforcée [502X62] Parrilla inoxidable / Stainless steel wire shelf / Grille Inox [502X46] Iluminación Led RGB con cambio de color [por puerta] / Led lighting RGB change of colour [per door] / LED RGB avec changement de couleur [par porte] Cerradura / Lock / Serrure [506X60]			Parrilla / Wire shelf / Grille [502X12] Cerradura / Lock / Serrure [506X209; 506X210] Grupo lado contrario / Group opposite side / Groupe opposé [L] Kit cajones / Drawer Kit / Kit tiroirs BMGN 1/2 x 200 [JCAJ17GN1/2] BMGN 1/3 x 100 [JCAJ17GN1/3] BMGN 2/3 + BMGN 1/3 [JCAJ17GN2/3]		



Serie / Series / Série **GN1/1 700**

+Info: [www.infrico.com](http://www.infrico.com)



F= Fregadero  
BMGN F

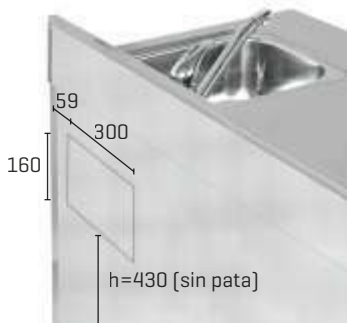

Opcional: Manejo control digital por WiFi o Bluetooth®

Optional: Operating digital control by WiFi or Bluetooth®

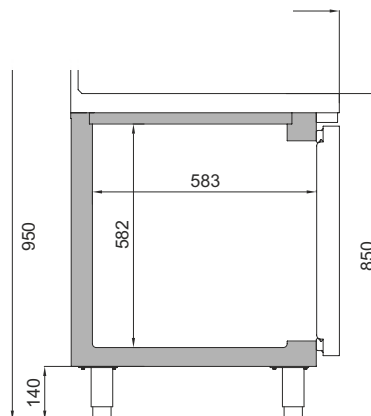

Kit 2 cajones  
2 drawers kit  
Kit 2 tiroirs

BM 1/2 x 200



Kit 2 cajones  
2 drawers kit  
Kit 2 tiroirs

BM 2/3x300 +  
BM 1/3x100

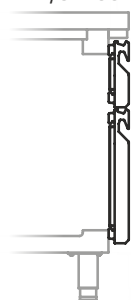

Kit 3 cajones  
3 drawers kit  
Kit 3 tiroirs

BM 1/3x100

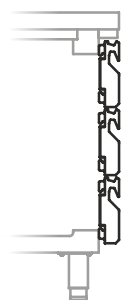

1/2                      2/3                      1/3  
302 x 518 x 205      302 x 518 x 307      302 x 518 x 105



KIT CAJONES / DRAWERS KIT / KIT TIROIRS (MOD. F)

**Mesa refrigerada pre-instalada /**  
**Remote undercounter refrigerator /**  
**Desserte dessus de comptoir groupe á distance**

**Mesa refrigerada central puertas a dos caras /**  
**Pass thru undercounter refrigerator /**  
**Desserte gastronomique positive traversante**



MODELO  
 MODELE  
 MODÈLE



Dos caras / Pass-thru / Traversante

**BMGN 1470 GR BMGN 1960 GR BMGN 2450 GR BMGN 1470 GRBT BMGN 1960 GRBT BMGN 2450 GRBT BMGN 1470 PDC BMGN 1960 PDC**

<b>Precio</b> Price Prix	<b>2.074 €</b>	<b>2.492 €</b>	<b>2.985 €</b>	<b>2.269 €</b>	<b>2.687 €</b>	<b>3.180 €</b>	<b>3.191 €</b>	<b>3.724 €</b>
<b>Medidas</b> Measures [mm] Mesures	1240 x 700 x 850 mm.	1732 x 700 x 850 mm.	2224 x 700 x 850 mm.	1240 x 700 x 850 mm.	1732 x 700 x 850 mm.	2224 x 700 x 850 mm.	1468 x 700 x 850 mm.	1960 x 700 x 850 mm.
<b>Temperatura</b> Temperature Température	<b>-2°C/+8°C</b>			<b>-18°C</b>			<b>-2°C/+8°C</b>	
<b>Clase Climática</b> Climatic class Classe climatique	-			-			5 / 40°C	
<b>Tensión/Frecuencia</b> Electrical data Tension électrique	230V/1ph/50Hz							
<b>Controlador</b> Controller Régulateur	Digital IP65							
<b>Material</b> Material [EXT/INT] Matériel	Inox AISI 304							
<b>Espesor</b> Thickness Épaisseur	70							
<b>Aislamiento</b> Isolation Isolation	40kg/m <sup>3</sup> / Free CFC's / Zero ODP-GWP							
<b>Capacidad</b> Capacity Capacité	305	465	630	305	465	630	290	440
<b>Puertas</b> Doors Portes	2	3	4	2	3	4	4	6
<b>Nº parrillas / Guías</b> Nº shelves / Slides Nº de grilles / Glissière	2/10 (325x530)	3/15 (325x530)	4/20 (325x530)	2/10 (325x530)	3/15 (325x530)	4/20 (325x530)	2/10 (325x530)	3/15 (325x530)
<b>Sistema de frío</b> Cooling System Système de froid	-						Monoblock ventilado / Forced air monoblock / Monoblock ventilé	
<b>Desescarche</b> Defrost Dégivrage	Parada compresor / Compressor off / Arrêt du compresseur			Gas caliente / Hot gas / Gaz chaud			Parada compresor / Compressor off / Arrêt du compresseur	
<b>Expansión</b> Expansion Expansion	-						Capilar / Capillary / Capillaire	
<b>Potencia</b> Power Puissance	-			-			210	368
<b>Potencia frig.</b> Cooling capacity Puissance Frig.	343	690	690	445	540	640	370	690
<b>Consumo</b> Consumption Consommation	-			-			1,50	1,95
<b>Clase energética</b> Energy class Classe Énerg.	-			-			<b>A</b>	<b>A</b>
<b>Refrigerante</b> Refrigerant Gaz	-						<b>R-290</b>	
<b>Opcional</b> Optional Options	Puerta de cristal / Glass door / Porte vitrée [PUE17IDGN-PUE17IIGN] Cerradura / Lock / Serrure [506X209; 506X210] Parrilla / Wire shelf / Grille [502X12]						<b>122 €</b>	
	Kit cajones / Drawer Kit / Kit tiroirs BMGN 1/2 x 200 [JCAJ17GN1/2] <b>643 €</b> BMGN 1/3 x 100 [JCAJ17GN1/3] <b>954 €</b> BMGN 2/3 + BMGN 1/3 [JCAJ17GN2/3] <b>711 €</b>			Kit cajones / Drawer Kit / Kit tiroirs Consultar / On request / À la demande 115V/1ph/60Hz <b>+ 3%</b> 230V/1ph/60Hz <b>Sin incremento / No increase / Sans supplément</b>			Juego de guías / Slides / Jeu de Glissières [GUIAC03505] <b>38 €</b>	
	Válvula de expansión (especificar refrigerante) Expansion valve (specify refrigerant) Détendeur d'expansion (spécifier le gaz souhaité) Juego de guías / Slides / Jeu de Glissières [GUIAC0115530, GUIAC0215530] <b>38 €</b>						Parrilla inoxidable / Stainless steel wire shelf / Grille Inox [502X46] <b>76 €</b>	

Serie / Series / Série **GN1/1 700**

+Info: [www.infrico.com](http://www.infrico.com)



**Possibilidad de acceso frontal y lateral para una mejor manipulación**

Front and lateral access for better handling

Possibilité d'accès frontal et latéral pour une meilleure manipulation.

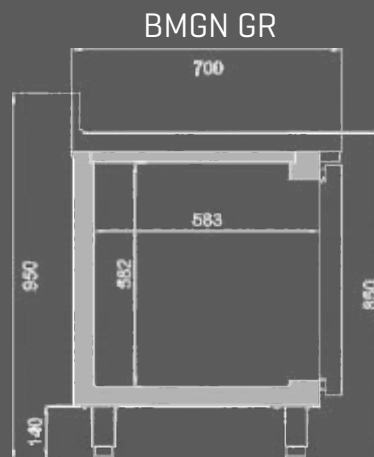
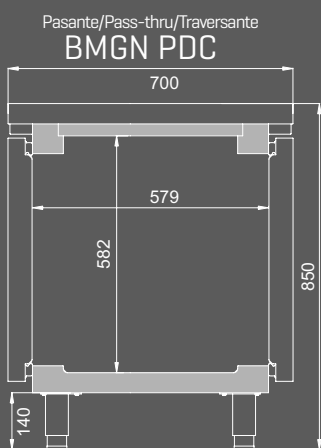

**Kit 2 cajones**  
2 drawers kit  
Kit 2 tiroirs

**Kit 2 cajones**  
2 drawers kit  
Kit 2 tiroirs

**Kit 3 cajones**  
3 drawers kit  
Kit 3 tiroirs

**1/2**  
**302 x 518 x 205**

**2/3**  
**302 x 518 x 307**

**1/3**  
**302 x 518 x 105**

BM 1/2 x 200

BM 2/3x300 +  
BM 1/3x100

BM 1/3x100

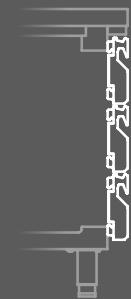

**KIT CAJONES / DRAWERS KIT / KIT TIROIRS (MOD. GR)**

**Mesa refrigerada ensaladas /**  
**Salad prep refrigerator table /**  
 Desserte gastronomique positive préparation salades

**Mesa refrigerada pizza /**  
**Pizza undercounter refrigerator /**  
 Desserte gastronomique positive préparation pizza

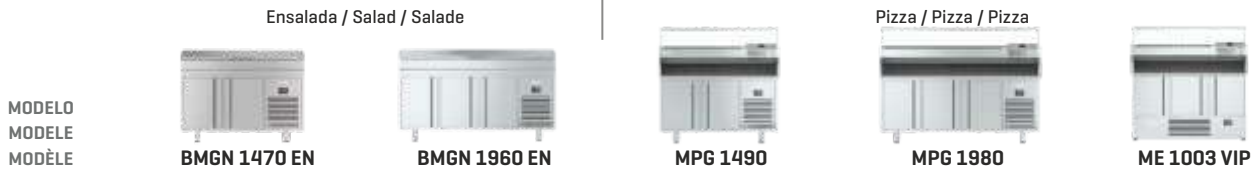

MODELO MODELE MODÈLE	BMGN 1470 EN	BMGN 1960 EN	MPG 1490	MPG 1980	ME 1003 VIP
<b>Precio</b> Price Prix					
<b>Medidas</b> Measures [mm] Mesures	1468 x 700 x 850/1100 mm.	1960 x 700 x 850/1100 mm.	1490 x 700 x 830/1417 mm.	1980 x 700 x 830/1417 mm.	1490 x 700 x 885/1417 mm.
<b>Temperatura</b> Temperature Température	0°/+6°C.		0°/+6°C. +4°C/+8°C.		
<b>Clase Climática</b> Climatic class Classe climatique	4 / 38°C				
<b>Tensión/Frecuencia</b> Electrical data Tension électrique	230V/1ph/50Hz				
<b>Controlador</b> Controller Régulateur	Digital IP65				
<b>Material</b> Material [EXT/INT] Matériel	Inox AISI 304				
<b>Espesor</b> Thickness Épaisseur	70				
<b>Aislamiento</b> Isolation Isolation	40kg/m <sup>3</sup> / Free CFC's / Zero ODP-GWP				
<b>Capacidad</b> Capacity Capacité	305+65	465+85	305+35	465+54	355+35
<b>Puertas</b> Doors Portes	2	3	2	3	3
<b>N° parrillas / Guías</b> N° shelves / Slides N° de grilles / Glissière	2/10 [325x530]	3/15 [325x530]	2/10 [325x530]	3/15 [325x530]	3/9 [325x530]
<b>Sistema de frío</b> Cooling System Système de froid	Monoblock ventilado / Forced air monoblock / Monoblock ventilé				
<b>Desescarche</b> Defrost Dégivrage	Parada compresor / Compressor off / Arrêt du compresseur				
<b>Expansión</b> Expansion Expansion	Capilar / Capillary / Capillaire				
<b>Potencia</b> Power Puissance	210	368	369	553	503
<b>Potencia frig.</b> Cooling capacity Puissance Frig.	370	690	370+170	690+170	690+170
<b>Consumo</b> Consumption Consommation	-	-	-	-	-
<b>Clase energética</b> Energy class Classe Énerg.	-	-	-	-	-
<b>Refrigerante</b> Refrigerant Gaz	R-290				
<b>Opcional</b> Optional Options	Parrilla / Wire shelf / Grille [502X12] Juego de guías / Slides / Jeu de Glissières [GUIAC0115530, GUIAC0215530] Cerradura / Lock / Serrure [506X209; 506X210] 230V/1ph/60Hz 115V/1ph/60Hz				
	[501X13] = 1 [501X11] = 6 [501X13] = 1 [501X11] = 9		[501X16] = 6 [501X13] = 1 [501X16] = 7		[501X16] = 6
	Ruedas / Casters / Roulettes [705X16=2; 705X17=2]				

Serie / Series / Série **GN1/1 700**

+Info: [www.infrico.com](http://www.infrico.com)

**IMPORTANT: Las bandejas deben contener producto previamente refrigerado.**  
**IMPORTANT: The trays should contain previously refrigerated product.**  
**IMPORTANT: Les plateaux doivent contenir des produits préalablement réfrigérés.**

**Refrigeración estática en la cuba**  
**Static cooling in the tank**  
**Refroidissement statique supérieur**

**BMGN 1960 EN**



**Granito**  
**Granite worktop**  
**Granit**

**Granito**  
**Granite worktop**  
**Granit**



**MPG 1980**



**ME 1003 VIP**

[501X16] = 6



[501X13] = 1 [501X16] = 7



[501X13] = 1 [501X11] = 6



[501X13] = 1 [501X11] = 9

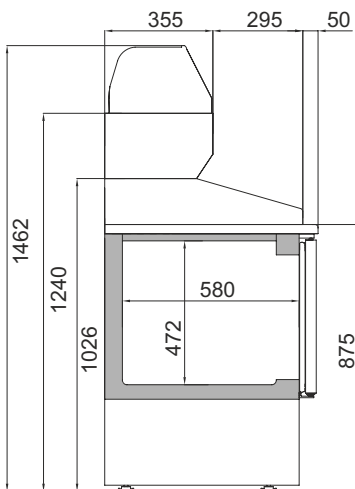

**ME VIP**

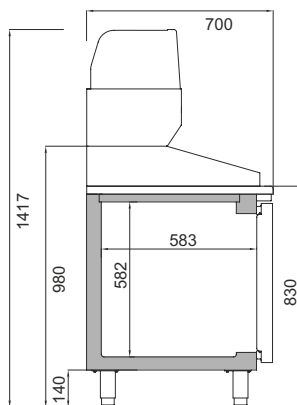



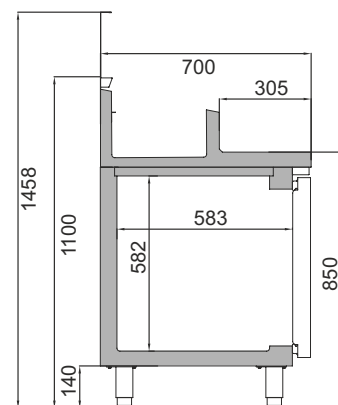

**MPG**



**BMGN EN**

# Mesa refrigerada ensaladas / Salad prep refrigerator table / Desserte gastronomique positive préparation salades



MODELO MODELE MODÈLE					
	ME 1000 BAN	ME 1000 EN	ME 1000 II	ME 1000 PIZZA	ME 1000 KB
<b>Precio</b> Price Prix					
<b>Medidas</b> Measures [mm] Mesures	978 x 700 x 890 mm.	978 x 700 x 895/1050 mm.	978 x 700 x 895 mm.	978 x 700 x 875/1140 mm.	978 x 700 x 865/1125 mm.
<b>Temperatura</b> Temperature Température	0°C/+6°C.				
<b>Clase Climática</b> Climatic class Classe climatique	4 / 38°C				
<b>Tensión/Frecuencia</b> Electrical data Tension électrique	230V/1ph/50Hz				
<b>Controlador</b> Controller Régulateur	Digital IP65				
<b>Material</b> Material [EXT/INT] Matériel	Inox AISI 304				
<b>Espesor</b> Thickness Épaisseur	55				
<b>Aislamiento</b> Isolation Isolation	40kg/m <sup>3</sup> / Free CFC's / Zero ODP-GWP				
<b>Capacidad</b> Capacity Capacité	230				
<b>Puertas</b> Doors Portes	2				
<b>Nº parrillas / Guías</b> Nº shelves / Slides Nº de grilles / Glissière	2/6 (325x530)				
<b>Sistema de frío</b> Cooling System Système de froid	Ventilado / Forced air / Ventilé				
<b>Desescarche</b> Defrost Dégivrage	Parada compresor / Compressor off / Arrêt du compresseur				
<b>Expansión</b> Expansion Expansion	Capilar / Capillary / Capillaire				
<b>Potencia</b> Power Puissance	210				
<b>Potencia frig.</b> Cooling capacity Puissance Frig.	370				
<b>Consumo</b> Consumption Consommation	-				
<b>Clase energética</b> Energy class Classe Énerg.	-				
<b>Refrigerante</b> Refrigerant Gaz	R-290				
<b>Opcional</b> Optional Options	Juego de guías / Slides / Jeu de Glissières [GUIACO115530; GUIACO215530] Kit 2 cajones 1x1/2 + 1x1/3 (Modelo II) / Drawers kit 1x1/2 + 1x1/3 (Model II) Kit tiroirs 1x1/2 + 1x1/3 (Modèle II) [JCAJ17ME1/2] Puerta de cristal / Glass door / Porte vitrée [PUE17IDME10-PUE17IIME10]		Parrilla / Wire shelf / Grille [502X12] Cerradura / Lock / Serrure [506X120; 506X121]		
	[501X11] = 6 [501X10] = 3	[501X16] = 5	-	[501X11] = 3 [501X10] = 1	[501X11] = 6 [501X10] = 3

Serie / Series / Série **GN1/1 700**

+Info: [www.infrico.com](http://www.infrico.com)



[501X11] = 6 [501X10] = 3

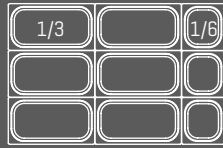

ME 1000 BAN



Opcional: Manejo control digital por WiFi o  Bluetooth®

Optional: Operating digital control by WiFi or  Bluetooth®



[501X16] = 5 

ME 1000 EN



Kit 2 cajones 1x1/2 + 1x1/3 [Modelo II] /  
Drawers kit 1x1/2 + 1x1/3 [Model II] /  
Kit tiroirs 1x1/2 + 1x1/3 [Modèle II] [JCAJ17ME1/2]

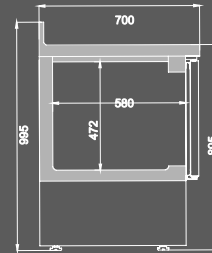

ME 1000 II



[501X11] = 3 [501X10] = 1 

ME 1000 PIZZA



[501X11] = 6 [501X10] = 3







ME 1000 KB



# Mesa refrigerada ensaladas / Salad prep refrigerator table / Desserte gastronomique positive préparation salades

2

MODELO MODELE MODÈLE					
	<b>ME 1003 BAN</b>	<b>ME 1003 EN</b>	<b>ME 1003 II</b>	<b>ME 1003 PIZZA</b>	<b>ME 1003 KB</b>
<b>Precio</b> Price Prix					
<b>Medidas</b> Measures [mm] Mesures	1460 x 700 x 890 mm.	1460 x 700 x 885/1050 mm.	1460 x 700 x 895 mm.	1460 x 700 x 875/1140 mm.	1460 x 700 x 865/1125 mm.
<b>Temperatura</b> Temperature Température	<b>0°C/+6°C.</b>				
<b>Clase Climática</b> Climatic class Classe climatique	4 / 38°C				
<b>Tensión/Frecuencia</b> Electrical data Tension électrique	230V/1ph/50Hz				
<b>Controlador</b> Controller Régulateur	Digital IP65				
<b>Material</b> Material [EXT/INT] Matériel	Inox AISI 304				
<b>Espesor</b> Thickness Épaisseur	40kg/m <sup>3</sup> / Free CFC's / Zero ODP-GWP				
<b>Aislamiento</b> Isolation Isolation	55				
<b>Capacidad</b> Capacity Capacité	355				
<b>Puertas</b> Doors Portes	3				
<b>Nº parrillas / Guías</b> Nº shelves / Slides Nº de grilles / Glissière	3/9 [325x530]				
<b>Sistema de frío</b> Cooling System Système de froid	Ventilado / Forced air / Ventilé				
<b>Desescarche</b> Defrost Dégivrage	Parada compresor / Compressor off / Arrêt du compresseur				
<b>Expansión</b> Expansion Expansion	Capilar / Capillary / Capillaire				
<b>Potencia</b> Power Puissance	368				
<b>Potencia frig.</b> Cooling capacity Puissance Frig.	690				
<b>Consumo</b> Consumption Consommation	-				
<b>Clase energética</b> Energy class Classe Énerg.	-				
<b>Refrigerante</b> Refrigerant Gaz	<b>R-290</b>				
<b>Opcional</b> Optional Options	Juego de guías / Slides / Jeu de Glissières [GUIACO115530; GUIACO215530] Kit 2 cajones 1x1/2 + 1x1/3 [Modelo II] / Drawers kit 1x1/2 + 1x1/3 [Model II] Kit tiroirs 1x1/2 + 1x1/3 [Modèle II] [JCAJ17ME1/2] Puerta de cristal / Glass door / Porte vitrée [PUE17IDME10-PUE17IIME10]			Parrilla / Wire shelf / Grille [502X12] Cerradura / Lock / Serrure [506X120; 506X121]	
	{501X11} = 9 {501X10} = 6	{501X16} = 8	-	{501X11} = 2 {501X10} = 4	{501X11} = 9 {501X10} = 6



Serie / Series / Série **GN1/1 700**

+Info: [www.infrico.com](http://www.infrico.com)



[501X11] = 9 [501X10] = 6

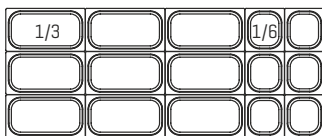

ME 1003 BAN

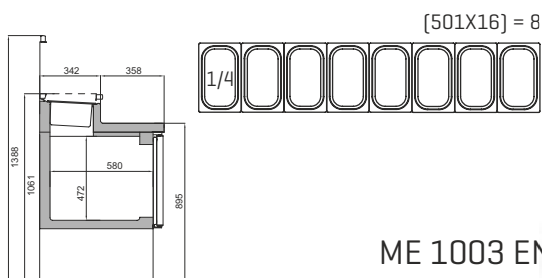

[501X16] = 8

ME 1003 EN



Kit 2 cajones 1x1/2 + 1x1/3 [Modelo II] /  
 Drawers kit 1x1/2 + 1x1/3 [Model II]  
 Kit tiroirs 1x1/2 + 1x1/3 [Modèle II]  
 [JCAJ17ME1/2]

1000 II

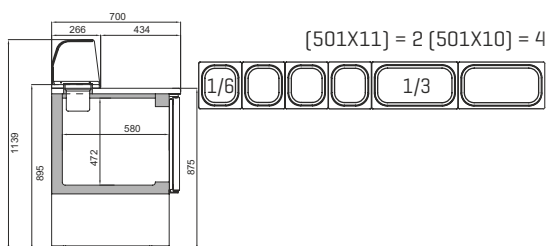

[501X11] = 2 [501X10] = 4

ME 1003 PIZZA



[501X11] = 9 [501X10] = 6

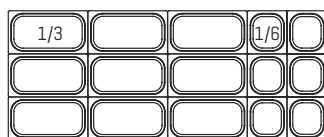

ME 1003 KB



# Mesa refrigerada cocktails / Cocktails refrigerator table / Desserte gastronomique positive préparation cocktails



MODELO  
MODELE  
MODÈLE



BST 1600 R



BST 2000 R



BST 1200 N



BST 1600 N



BST 2000 N

MODELO MODELE MODÈLE	BST 1600 R	BST 2000 R	BST 1200 N	BST 1600 N	BST 2000 N
<b>Precio</b> Price Prix					
<b>Medidas</b> Measures [mm] Mesures	1600 x 700 x 1059 mm.	2000 x 700 x 1059 mm.	1200 x 600 x 944 mm.	1600 x 600 x 944 mm.	2000 x 600 x 944 mm.
<b>Temperatura</b> Temperature Température	-2°C/+8°C.			-	
<b>Clase Climática</b> Climatic class Classe climatique	4 / 38°C			-	
<b>Tensión/Frecuencia</b> Electrical data Tension électrique	230V/1ph/50Hz			-	
<b>Controlador</b> Controller Régulateur	Digital IP65			-	
<b>Material</b> Material [EXT/INT] Matériel	Inox AISI 304				
<b>Aislamiento</b> Isolation Isolation	40kg/m <sup>3</sup> / Free CFC's / Zero ODP-GWP				
<b>Cuba para hielo</b> Ice tank Bac à glace	Inyectada y refrigerada Injected and refrigerated Injecté et réfrigéré		Inyectada / Injected / Injecté		
<b>Capacidad Snack</b> Capacity Snack Capacité Snack	255	310	-	-	-
<b>Cajones</b> Drawers Tiroirs	4	6	-	-	-
<b>Enchufe accesorios</b> Accessories Plug Prise pour accessoires	Sí / Yes / Oui			-	
<b>Sistema de frío</b> Cooling System Système de froid	Ventilado / Forced air / Ventilé			-	
<b>Desescarche</b> Defrost Dégivrage	Parada compresor / Compressor off / Arrêt du compresseur			-	
<b>Expansión</b> Expansion Expansion	Capilar / Capillary / Capillaire			-	
<b>Potencia</b> Power Puissance	210	368		-	
<b>Potencia frig.</b> Cooling capacity Puissance Frig.	370	690		-	
<b>Consumo</b> Consumption Consommation	1.61	1.77		-	
<b>Clase energética</b> Energy class Classe Énerg.	-				
<b>Refrigerante</b> Refrigerant Gaz	R-290			-	
<b>Opcional</b> Optional Options	Cerradura / Lock / Serrure (506X209; 506X210) Puerta (unidad) / Door (unit) / Porte (unité) (PUE17ISN) Ruedas / Casters / Roulettes Cubetas 1/9 / Bacs 1/9 / Cuves 1/9 Doble carril de botellas / Double speed rack / Double rail à bouteilles  115V/1ph/60Hz 230V/1ph/60Hz		Ruedas / Casters / Roulettes  Cubetas 1/9 / Bacs 1/9 / Cuves 1/9  Doble carril de botellas / Double bottle lane / Double rail à bouteilles	Ruedas / Casters / Roulettes  Cubetas 1/9 / Bacs 1/9 / Cuves 1/9  Doble carril de botellas / Double bottle lane / Double rail à bouteilles	

Serie / Series / Série **BARSTATION**

+Info: [www.infrico.com](http://www.infrico.com)



Los datos técnicos están sujetos a posibles variaciones que serán actualizadas periódicamente en las fichas técnicas del producto, disponibles en la web /  
The technical data are subject to possible variations that will be updated periodically in the technical data sheets of the product, which are available on the website /  
Les données techniques peuvent varier et seront actualisées dans les fiches techniques du produit, disponibles sur le site web.

# Mesa refrigeración y congelación Euronorma 600x400 pastelería / Euronorm 600x400 refrigerator and freezer counter / Tour pâtissier positif et négatif Euronorme 600x400

EURONORM 600x400

MODELO  
MODELE  
MODÈLE



MR 1620

MR 2190

MR 2750

MR 1620 BT

MR 2190 BT

Precio Price Prix						
Medidas Measures [mm] Mesures	1618 x 800 x 850 mm.	2185 x 800 x 850 mm.	2752 x 800 x 850 mm.	1618 x 800 x 850 mm.	2185 x 800 x 850 mm.	
Temperatura Temperature Température	-2°C/+8°C			-18°C		
Clase Climática Climatic class Classe climatique	5 / 40°C			4 / 38°C		
Tensión/Frecuencia Electrical data Tension électrique	230V/1ph/50Hz					
Controlador Controller Régulateur	Digital IP65					
Material Material [EXT/INT] Matériel	Inox AISI 304					
Espesor Thickness Épaisseur	70					
Aislamiento Isolation Isolation	40kg/m <sup>3</sup> / Free CFC's / Zero ODP-GWP					
Capacidad Capacity Capacité	420	635	850	420	635	
Puertas Doors Portes	2	3	4	2	3	
Nº parrillas / Guías Nº shelves / Slides Nº de grilles / Glissière	2/10 [600x400]	3/15 [600x400]	4/20 [600x400]	2/10 [600x400]	3/15 [600x400]	
Sistema de frío Cooling System Système de froid	Monoblock ventilado / Forced air monoblock / Monoblock ventilé					
Desescarche Defrost Dégivrage	Parada compresor / Compressor off / Arrêt du compresseur			Gas caliente / Hot gas defrost / Gaz chaud		
Expansión Expansion Expansion	Capilar / Capillary / Capillaire			Válvula de expansión termostática / Thermostatic expansion valve / Détendeur thermostatique		
Potencia Power Puissance	368			568	712	
Potencia frig. Cooling capacity Puissance Frig.	690			540	639	
Consumo Consumption Consommation	1,67	2,07	3,06	6,03	11,15	
Clase energética Energy class Classe Énerg.	A		B	C	D	
Refrigerante Refrigerant Gaz	R-290					
Opcional Optional Options	Granito / Granite-top / Granit MR1620 [1618X800X30] [606X35] Granito / Granite-top / Granit MR2190 [2185X800X30] [606X36] Granito / Granite-top / Granit MR2750 [2752X800X30] [606X37] Bandeja Inox/ Stainless Steel Tray / Bac Inox 600x400 [A850P41] Cerradura / Lock / Serrure [506X209; 506X210]			Parrilla / Wire shelf / Grille [502X26] Juego de guías / Slides / Jeu de Glissières [GUAL0120641, GUAL0220641] Ruedas / Casters / Roulettes [705X16=2; 705X17=2]		
	115V/1ph/60Hz 230V/1ph/60Hz			115V/1ph/60Hz 230V/1ph/60Hz		

Serie / Series / Série **800**

+Info: [www.infrico.com](http://www.infrico.com)

MR 2750



MR 2190 BT

Opcional  
Optional  
Option



Controlador digital IP 65.  
Digital control IP65  
Contrôleur digital IP 65.

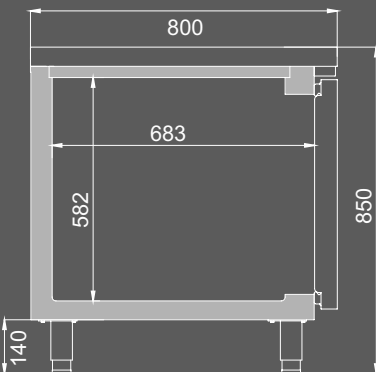

**Frío Ventilado con efecto estático para pastelería profesional**  
Ventilated cooling with static effect for professional patisseries  
Refroidissement ventilé avec effet statique pour les pâtisseries professionnelles

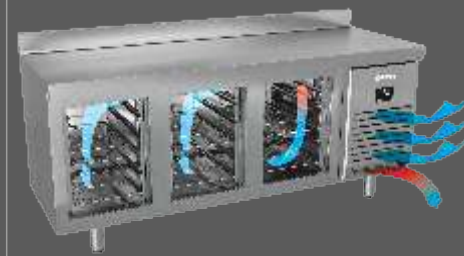



Opcional: Manejo control digital por WiFi o Bluetooth  
Optional: Operating digital control by WiFi or Bluetooth

Opcional granito  
Optional granite worktop  
Option granite



**Mesa refrigeración 600x400 puerta cristal /**  
**600x400 glass door counter refrigerator /**  
 Tour pâtissier positif 600x400 porte vitrée

**Mesa refrigeración 600x400 remota /**  
**600x400 remote counter refrigerator /**  
 Tour pâtissier positif 600x400 groupe à distance

Grupo remoto / Remote / Groupe à distance

MODELO  
 MODELE  
 MODÈLE



MR 1620 CR



MR 2190 CR



MR 2750 CR



MR 1620 GR



MR 2190 GR



MR 2750 GR

Precio Price Prix						
Medidas Measures [mm] Mesures	1618 x 800 x 850 mm.	2185 x 800 x 850 mm.	2752 x 800 x 850 mm.	1390 x 800 x 850 mm.	1957 x 800 x 850 mm.	2524 x 800 x 850 mm.
Temperatura Temperature Température	+2°C/+6°C.			-2°C/+8°C.		
Clase Climática Climatic class Classe climatique	4 / 38°C.			5 / 40°C.		
Tensión/Frecuencia Electrical data Tension électrique	230V/1ph/50Hz					
Controlador Controller Régulateur	Digital IP65					
Material Material [EXT/INT] Matériel	Inox AISI 304					
Espesor Thickness Épaisseur	70					
Aislamiento Isolation Isolation	40kg/m <sup>3</sup> / Free CFC's / Zero ODP-GWP					
Capacidad Capacity Capacité	420	635	850	420	635	850
Puertas Doors Portes	2	3	4	2	3	4
Nº parrillas / Guías Nº shelves / Slides Nº de grilles / Glissière	2/10 (600x400)	3/15 (600x400)	4/20 (600x400)	2/10 (600x400)	3/15 (600x400)	4/20 (600x400)
Sistema de frío Cooling System Système de froid	Monoblock ventilado / Forced air monoblock / Monoblock ventilé			-		
Desescarche Defrost Dégivrage	Parada compresor / Compressor off / Arrêt du compresseur					
Expansión Expansion Expansion	Capilar / Capillary / Capillaire			Válvula expansión opcional [especificar refrig.] Expansion valve optional [specify refrigerant] Détendeur options [spécifier le gaz]		
Potencia Power Puissance	378	383	389	368		
Potencia frig. Cooling capacity Puissance Frig.	690			Recom. 690		
Consumo Consumption Consommation	-			-		
Clase energética Energy class Classe Énerg.	-			-		
Refrigerante Refrigerant Gaz	R-290			-		
Opcional Optional Options	Juego de guías / Slides / Jeu de Glissières [GUALO120641, GUALO220641]					
	Parrilla doble tupida / Extradense wire shelf / Grille renforcée [502X64] Granito / Granite-top / Granit MR1620 [1618X800X30] [606X35] Granito / Granite-top / Granit MR2190 [2185X800X30] [606X36] Granito / Granite-top / Granit MR2750 [2752X800X30] [606X37] Cerradura / Lock / Serrure [506X60] Parrilla Inox / Stainless steel wire shelf / Grille inox [502X47] Bandeja Inox / Stainless Steel Tray / Bac Inox 600x400 [A850P41] Iluminación Led RGB con cambio de color [por puerta] / Led lighting RGB change of colour [per door] / LED RGB avec changement de couleur [par porte]			Parrilla / Wire shelf / Grille [502X26] Puerta de cristal / Glass door / Porte vitrée [PUE17IDMR-PUE17IIMR] Cerradura / Lock / Serrure [506X209; 506X210] Bandeja Inox / Stainless Steel Tray / Bac Inox 600x400 [A850P41] Válvula expansión opcional [especificar refrig.] Expansion valve optional [specify refrigerant] Détendeur options [spécifier le gaz]		

Serie / Series / Série **800**

+Info: [www.infrico.com](http://www.infrico.com)



**Posibilidad de acceso frontal y lateral para una mejor manipulación**  
 Front and lateral access for better handling  
 Possibilité d'accès frontal et latéral pour une meilleure manipulation.

**Aumentan en su largo 8 cm. para una mejor manipulación.**  
 They increase in their length 8 cm. for better handling.  
 8 cm. de long en plus pour une meilleure manipulation.



MR 2190 GR

**Doble cristal templado bajo emisivo más carga Argón 4-27-4**  
 Double tempered glass low-e + Argón 4-27-4  
 Double vitrage trempé à faible émissivité avec Argón 4-27-4



**Opcional granito**  
 Optional granite worktop  
 Option granite

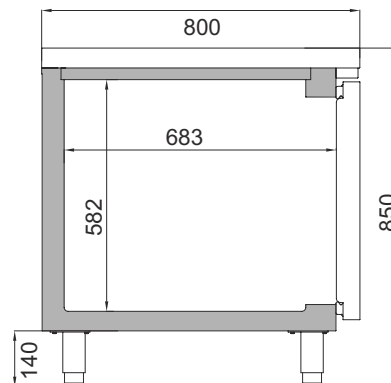

**Mesa refrigerada central  
600x400 puerta dos caras /  
600x400 pass thru counter refrigerator /  
Tour pâtissier positif 600x400 traversante**

**Mesa refrigerada 600x400 para ensaladas,  
pizza y pastelería / 600x400 salads, pizza and  
pastry prep counter refrigerator / Table positive  
600x400 préparation salades, pizzas et pâtisseries**

EURONORM 600x400

Pasante/Pass-thru/Traversante

EURONORM 600x400  
Ensalada, pizza y pastelería  
Salads, pizza & pastry  
Salade, pizza et pâtisserie

MODELO  
MODELE  
MODÈLE



MR 1620 PDC

MR 2190 PDC

MR 1620 PDCR

MR 2190 PDCR

MR 1620 EN

MR 2190 EN

Precio Price Prix						
Medidas Measures [mm] Mesures	1618 x 800 x 850 mm.	2185 x 800 x 850 mm.	1618 x 800 x 850 mm.	2185 x 800 x 850 mm.	1618 x 800 x 850/1050 mm.	2185 x 800 x 850/1050 mm.
Temperatura Temperature Température	<b>-2°C/+8°C</b>		<b>+2°C/+6°C</b>		<b>0°C/+6°C</b>	
Clase Climática Climatic class Classe climatique	5 / 40°C		4 / 38°C		4 / 38°C	
Tensión/Frecuencia Electrical data Tension électrique	230V/1ph/50Hz					
Controlador Controller Régulateur	Digital IP65					
Material Material [EXT/INT] Matériel	Inox AISI 304					
Espesor Thickness Épaisseur	70					
Aislamiento Isolation Isolation	40kg/m <sup>3</sup> / Free CFC's / Zero ODP-GWP					
Capacidad Capacity Capacité	420	635	420	635	420+55	635+80
Puertas Doors Portes	4	6	4	6	2	3
Nº parrillas / Guías Nº shelves / Slides Nº de grilles / Glissière	2/10 {600x400}	3/15 {600x400}	2/10 {600x400}	3/15 {600x400}	2/10 {600x400}	3/15 {600x400}
Sistema de frío Cooling System Système de froid	Monoblock ventilado / Forced air monoblock / Monoblock ventilé					
Desescarche Defrost Dégivrage	Parada compresor / Compressor off / Arrêt du compresseur					
Expansión Expansion Expansion	Capilar / Capillary / Capillaire					
Potencia Power Puissance	368		387	398	368	
Potencia frig. Cooling capacity Puissance Frig.	690					
Consumo Consumption Consommation	1,67	2,07	-			
Clase energética Energy class Classe Énerg.	<b>A</b>		<b>A</b>		-	
Refrigerante Refrigerant Gaz	<b>R-290</b>					
Opcional Optional Options	Parrilla / Wire shelf / Grille [502X26] Bandeja Inox/ Stainless Steel Tray / Bac Inox 600x400 [A850P41] Juego de guías / Slides / Jeu de Glissières [GUIAL0120641, GUIAL0220641]			Cerradura / Lock / Serrure [506X209; 506X210]		
	Parrilla doble tupida / Extradense wire shelf / Grille renforcée [502X64] Granito / Granite-top / Granit MR1620 [1618X800X30] [606X35] Granito / Granite-top / Granit MR2190 [2185X800X30] [606X36] Cerradura / Lock / Serrure [506X60] [PDCR] Parrilla Inox / Stainless steel wire shelf / Grille inox [502X47]				Parrilla de trabajo / Garnish rack / Grille travail [PTMP] Ruedas / Casters / Roulettes [705X16=2; 705X17=2]	
					[501X16] = 9	[501X16] = 13



Serie / Series / Série 800

+Info: [www.infrico.com](http://www.infrico.com)

Opcional  
Optional  
Option

Pasante/Pass-thru/Traversante  
MR 2190 PDC



Pasante/Pass-thru/Traversante  
MR PDC

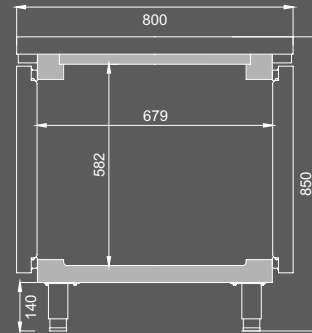

[501X16] = 9



[501X16] = 13

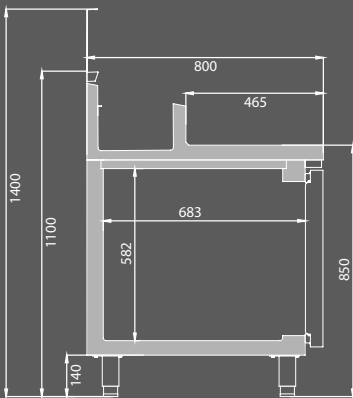

MR 1620 EN

Refrigeración estática en la cuba  
Static cooling in the tank  
Refrroidissement statique



# Mesa refrigerada ventilada con control de humedad / Ventilated refrigerated table with humidity control / Table réfrigérée ventilée avec contrôle de l'humidité

MODELO  
MODELE  
MODÈLE



MR 1620 H

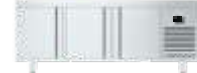

MR 2190 H

Precio Price Prix		
Medidas Measures [mm] Mesures	1618 x 800 x 850 mm.	2185 x 800 x 850 mm.
Temperatura Temperature Température	+2°C/+8°C Humedad / humidity / humidité 45% HR / 85% HR	
Clase Climática Climatic class Classe climatique	4 / 38°C	
Tensión/Frecuencia Electrical data Tension électrique	230V/1ph/50Hz	
Controlador Controller Régulateur	Digital IP65 con control de humedad / Digital IP65 with humidity control / Digital IP65 avec contrôle de l'humidité	
Material Material [EXT/INT] Matériel	Inox AISI 304	
Espesor Thickness Épaisseur	70	
Aislamiento Isolation Isolation	40kg/m <sup>3</sup> / Free CFC's / Zero ODP-GWP	
Capacidad Capacity Capacité	420	635
Puertas Doors Portes	2	3
Nº parrillas / Guías Nº shelves / Slides Nº de grilles / Glissière	2/10 [600x400]	3/15 [600x400]
Sistema de frío Cooling System Système de froid	Monoblock ventilado / Forced air monoblock / Monoblock ventilé	
Desescarche Defrost Dégivrage	Parada compresor / Compressor off / Arrêt du compresseur	
Expansión Expansion Expansion	Capilar / Capillary / Capillaire	
Potencia Power Puissance	868	
Potencia frig. Cooling capacity Puissance Frig.	690	
Consumo Consumption Consommation	-	-
Clase energética Energy class Classe Énerg.	-	
Refrigerante Refrigerant Gaz	<b>R-290</b>	
Opcional Optional Options	<p>Granito / Granite-top / Granit MR1620 [1618X800X30] [606X35] Granito / Granite-top / Granit MR2190 [2185X800X30] [606X36] Bandeja Inox/ Stainless Steel Tray / Bac Inox 600x400 [A850P41] Cerradura / Lock / Serrure [506X209; 506X210] 115V/1ph/60Hz 230V/1ph/60Hz</p>	<p>Parrilla / Wire shelf / Grille [502X26] Juego de guías / Slides / Jeu de Glissières [GUIAL0120641, GUIAL0220641] Ruedas / Casters / Roulettes [705X16=2; 705X17=2]</p>

Serie / Series / Série **MR H**

+Info: [www.infrico.com](http://www.infrico.com)

**Control electrónico de Temperatura y Humedad**  
**Electronic Temperature and Humidity control**  
**Contrôle électronique de la Température et de l'humidité**



**Opcional granito**  
**Optional granite worktop**  
**Option granite**



MR 1620 H



MR 2190 H



**Mesa refrigerada  
pizza Lucena /  
Pizza prep table Lucena /  
Table positive et fast  
food Lucena  
(MPL)**

**Mesa refrigerada pizza /  
Pizza prep table /  
Table positive pizza  
(MP)**

MODELO  
MODELE  
MODÈLE



MPL 1740



MPL 2300



MP 1740



MP 2300



MP 1740 CN



MP 2300 CN

MODELO MODELE MODÈLE	MPL 1740	MPL 2300	MP 1740	MP 2300	MP 1740 CN	MP 2300 CN
<b>Precio</b> Price Prix						
<b>Medidas</b> Measures [mm] Mesures	1693 x 800 x 850/1010 mm.	2260 x 800 x 850/1010 mm.	1738 x 800 x 830/980 mm.	2305 x 800 x 830/980 mm.	1738 x 800 x 830/980 mm.	2305 x 800 x 830/980 mm.
<b>Temperatura</b> Temperature Température	+2°C/+6°C					
<b>Clase Climática</b> Climatic class Classe climatique	4 / 38°C			5 / 40°C		
<b>Tensión/Frecuencia</b> Electrical data Tension électrique	230V/1ph/50Hz					
<b>Controlador</b> Controller Régulateur	Digital IP65					
<b>Material</b> Material [EXT/INT] Matériel	Inox AISI 304					
<b>Espesor</b> Thickness Épaisseur	55					
<b>Aislamiento</b> Isolation Isolation	40kg/m <sup>3</sup> / Free CFC's / Zero ODP-GWP					
<b>Capacidad</b> Capacity Capacité	485	700	485+48	700+70	[R] 235 [V] 48 [N] 175	[R] 485 [V] 70 [N] 175
<b>Puertas</b> Doors Portes	2	3	2	3	1 + Neutro	2 + Neutro
<b>Nº parrillas / Guías</b> N° shelves / Slides N° de grilles / Glissière	2/10 [600x400]	3/15 [600x400]	7 [600x400]	10 [600x400]	8 [600x400]	11 [600x400]
<b>Sistema de frío</b> Cooling System Système de froid	Ventilado / Forced air / Ventilé					
<b>Desescarche</b> Defrost Dégivrage	Parada compresor / Compressor off / Arrêt du compresseur					
<b>Expansión</b> Expansion Expansion	Capilar / Capillary / Capillaire					
<b>Potencia</b> Power Puissance	368		553		350	553
<b>Potencia frig.</b> Cooling capacity Puissance Frig.	690		690		370	690
<b>Refrigerante</b> Refrigerant Gaz	<b>R-290</b>					
<b>Opcional</b> Optional Options	Parrilla/Wire shelf/Grille [502X26] Juego de guías/Slides/Jeu de Glissières [GUAL0120641; GUAL0220641] Parrilla de trabajo / Garnish rack / Grille travail [PTMT] [MPL1740-3UD] [MPL2300-4UD] Cerradura / Lock / Serrure [506X209; 506X210] Ruedas / Casters / Roulettes [705X16=2; 705X17=2]		Parrilla/Wire shelf/Grille [502X26] Juego de guías/Slides/Jeu de Glissières [GUAL0120641; GUAL0220641] Opción neutro 6 cajones / Optional 6 drawers dry store / En option kit 6 tiroirs neutres [JCAJ17MP6] [Sólo / Only / Seulement MP2300CN] Contenedor polipropileno / Polypropylene container / Container polypropylène [501X08] Cerradura / Lock / Serrure [506X209; 506X210] 115V/1ph/60Hz 230V/1ph/60Hz			
	[501X14] = 1 [501X11] = 5 [501X10] = 4	[501X14] = 1 [501X11] = 8 [501X10] = 4	[501X13] = 1 [501X16] = 5	[501X13] = 1 [501X16] = 9	[501X13] = 1 [501X16] = 5	[501X13] = 1 [501X16] = 9

Serie / Series / Série **800**

+Info: [www.infrico.com](http://www.infrico.com)

**IMPORTANTE:** Las bandejas deben contener producto previamente refrigerado.  
**IMPORTANT:** The trays should contain previously refrigerated product.  
**IMPORTANT:** Les plateaux doivent contenir des produits préalablement réfrigérés.

[501X14] = 1 [501X11] = 8 [501X10] = 4



[501X14] = 1 [501X11] = 5 [501X10] = 4

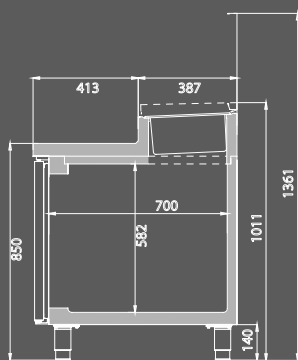

**MPL 2300**

Parrillas de trabajo  
Garnish racks  
Grilles de travail



Cajón refrigerado de serie  
Refrigerated drawer standard  
Tiroir réfrigéré de série

[501X13] = 1 [501X16] = 9



[501X13] = 1 [501X16] = 5



**Video del producto**

Product Video  
Vidéo du produit



Infrico Youtube

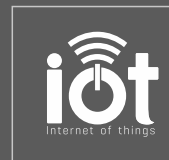

Opcional: Manejo control digital por WiFi o Bluetooth®  
Optional: Operating digital control by WiFi or Bluetooth®



Vitrina de ingredientes incluida  
Included ingredients display  
De série vitrine avec couvercle vitré

**MP 2300 CN**

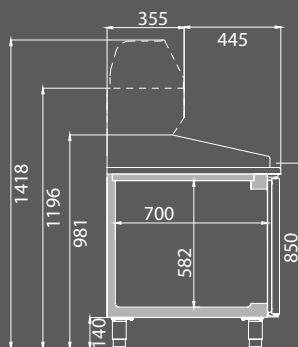

Opcional kit neutro 6 cajones  
Optional 6 neutral drawers  
En option kit 6 tiroirs neutres



Cajón refrigerado de serie  
Refrigerated drawer standard  
Tiroir réfrigéré de série

**Frente mostrador /**  
**Back-bar counter refrigerator /**  
**Desserte arrière bar positive cafétéria**

**Frente mostrador refrigerado preinstalado /**  
**Remote back-bar counter refrigerator /**  
**Desserte arrière bar groupe à distance cafétéria**



MODELO  
 MODELE  
 MODÈLE



Preinstalado / Remote / À distance

	FMPP1500 II	FMPP2000 II	FMPP2500 II	FMPP1500 CR	FMPP2000 CR	FMPP2500 CR	FMPP1500 GR	FMPP2000 GR	FMPP2500 GR
Precio Price Prix									
Medidas Measures [mm] Mesures	1468 x 600 x 1050 mm.	1960 x 600 x 1050 mm.	2452 x 600 x 1050 mm.	1468 x 600 x 1050 mm.	1960 x 600 x 1050 mm.	2452 x 600 x 1050 mm.	1240 x 600 x 1050 mm.	1732 x 600 x 1050 mm.	2224 x 600 x 1050 mm.
Temperatura Temperature Température	<b>-2°C/+8°C</b>			<b>+2°C/+6°C</b>			<b>0°C/+6°C</b>		
Clase Climática Climatic class Classe climatique	5 / 40°C			4 / 38°C			-		
Tensión/Frecuencia Electrical data Tension électrique	230V/1ph/50Hz								
Controlador Controller Régulateur	Digital IP65								
Material Material [EXT/INT] Matériel	Inox AISI 304								
Espesor Thickness Épaisseur	70								
Aislamiento Isolation Isolation	40kg/m <sup>3</sup> / Free CFC's / Zero ODP-GWP								
Capacidad Capacity Capacité	340	520	690	340	520	690	340	520	690
Puertas Doors Portes	2	3	4	2	3	4	2	3	4
Nº parrillas / Guías Nº shelves / Slides Nº de grilles / Glissière	4/4 [325x430]	6/6 [325x430]	8/8 [325x430]	4/4 [325x430]	6/6 [325x430]	8/8 [325x430]	4/4 [325x430]	6/6 [325x430]	8/8 [325x430]
Sistema de frío Cooling System Système de froid	Monoblock ventilado / Forced air monoblock / Monoblock ventilé						-		
Desescarche Defrost Dégivrage	Parada compresor / Compressor off / Arrêt du compresseur								
Expansión Expansion Expansion	Capilar / Capillary / Capillaire						Válvula expansión opcional (especificar refrigerante) Expansion valve optional (specify refrigerant) Détendeur options (spécifier le gaz)		
Potencia Power Puissance	209	308		377	382	387	-		
Potencia frig. Cooling capacity Puissance Frig.	370	690				Recom. 370		Recom. 690	
Consumo Consumption Consommation	1,55	2,06	2,35	-					
Clase energética Energy class Classe Énerg.	<b>A</b>	<b>A</b>	<b>A</b>	-					
Refrigerante Refrigerant Gaz	<b>R-290</b>								
Opcional Optional Options	Juego de guías / Slides / Jeu de Glissières [GUIAC0115430, GUIAC0215430] Parrilla doble tupida / Extradense wire shelf / Grille renforcée [502X43] Parrilla inoxidable / Stainless steel wire shelf / Grille Inox [502X49] Iluminación Led RGB con cambio de color (por puerta) / Led lighting RGB change of colour (per door) / LED RGB avec changement de couleur (par porte)					Parrilla / Wire shelf / Grille [502X07] Cerradura / Lock / Serrure [506X209; 506X210] Cerradura / Lock / Serrure [506X60] [Mod. CR]			
	Kit cajones / Drawer Kit / Kit tiroirs FM 350 + FM 250 [JCAJ17FM3525] BM 2 x 1/2x200 + 1 x 1/3x100 [JCAJ17FM1/2] BM 2/3 x 300 [JCAJ17FM2/3]					-			
	Tolva / Coffe grounds hopper / Tiroir marc à café [TOL17FM] Grupo lado contrario / Group opposite side / Groupe opposé [L]					Válvula expansión opcional (especificar refrigerante) Expansion valve optional (specify refrigerant) Détendeur options (spécifier le gaz)			

Serie / Series / Série **600**

+Info: [www.infrico.com](http://www.infrico.com)

FMPP 2000 GR



22cm

**Posibilidad de acceso frontal y lateral para una mejor manipulación.**

Front and lateral access for better handling.  
Possibilité d'accès frontal et latéral pour une meilleur manipulation.

**Controlador digital IP 65.**  
Digital control IP65  
Contrôleur digital IP 65.



FMPP 2000 CR



**Tolva Opcional**  
Coffe grounds hopper Optional  
Tiroir marc à café Options

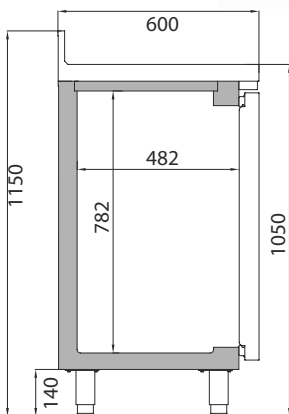

<b>FM 250</b> 302 x 418 x 255	<b>1/3</b> 302 x 418 x 105	
<b>FM 350</b> 302 x 418 x 352	<b>1/2</b> 302 x 418 x 205	<b>2/3</b> 302 x 418 x 307

<b>Kit 2 cajones</b> 2 drawers kit Kit 2 tiroirs	<b>Kit 3 cajones</b> 3 drawers kit Kit 3 tiroirs	<b>Kit 2 cajones</b> 2 drawers kit Kit 2 tiroirs
FM 350 + FM 250	2 x BM 1/2 x 200 1 x BM 1/3 x 100	BM 2 x 2/3 x 300

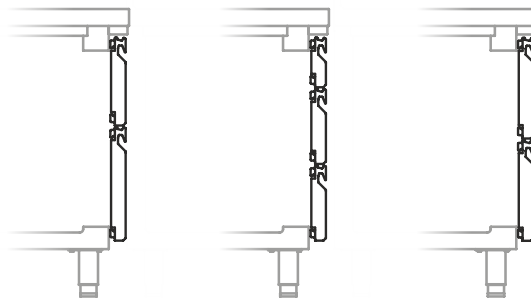

**KIT CAJONES / DRAWERS KIT / KIT TIROIRS (MOD. II - GR)**

**Mueble mesa cafetera /**  
Coffe unit /  
Meuble caf  teria

Serie / Series / S  rie **MCAF**

2

MODELO MODELE MOD��LE	MCAF 820	MCAF 1000 CD	MCAF 1000 CI	MCAF 1500	MCAF 2000	MCAF 2500
Precio Price Prix						
Medidas Measures Mesures [mm]	820 x 600 x 1050 mm.	1000 x 600 x 1050 mm.	1000 x 600 x 1050 mm.	1468 x 600 x 1050 mm.	1960 x 600 x 1050 mm.	2450 x 600 x 1050 mm.
Material Material Mat��riel [EXT/INT]	Inox AISI 304					
Opcional Optional Options	Posibilidad de fabricar a medida sin modificar fondo ni cuerpo central. Possibility of custom-made manufacturing without modifying the depth or central body. Possibilit�� de fabriquer sur mesure sans modifier ni la profondeur ni la partie centrale.					

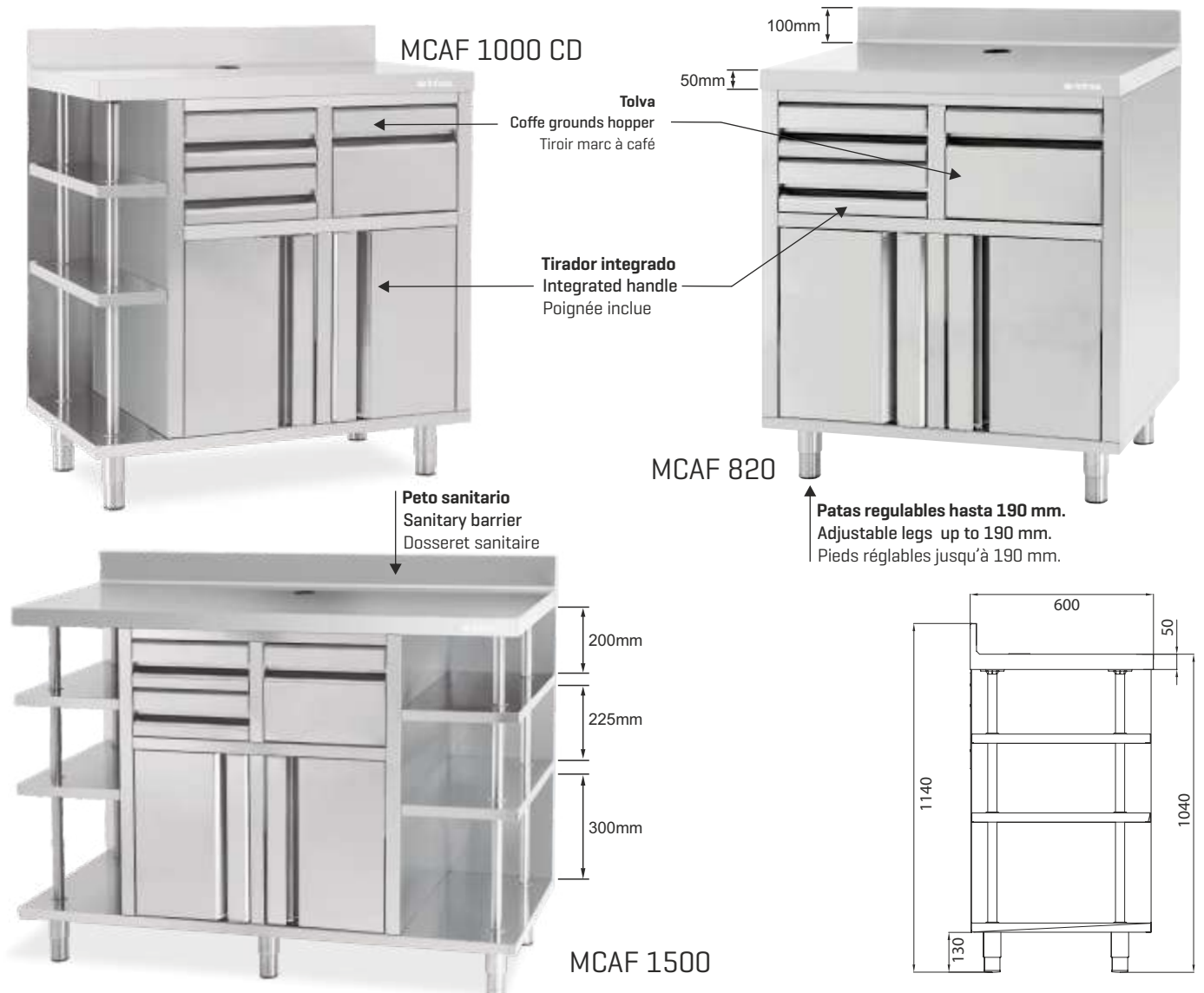

















**Mueble estantería y mesa de trabajo /**  
**Shelf unit and working table /**  
**Meuble étagère et table de travail**

+Info: [www.infrico.com](http://www.infrico.com)

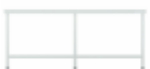
**Serie / Series / Série ME / MT**

MUEBLE ESTANTERÍA / SHELF UNIT / MEUBLE ÉTAGÈRE

MODELO MODELE MODÈLE								
MODELO MODELE MODÈLE	ME 30/1000	ME 30/1500	ME 30/2000	ME 30/2500	ME 60/1000	ME 60/1500	ME 60/2000	ME 60/2500
Precio Price Prix								
Medidas Measures (mm) Mesures	1000 x 300 x 1050mm.	1468 x 300 x 1050mm.	1960 x 300 x 1050mm.	2452 x 300 x 1050mm.	1000 x 600 x 1050mm.	1468 x 600 x 1050mm.	1960 x 600 x 1050mm.	2452 x 600 x 1050mm.
MESA DE TRABAJO / WORKING TABLE / TABLE DE TRAVAIL								
MODELO MODELE MODÈLE								
MODELO MODELE MODÈLE	MT 60/1000	MT 60/1500	MT 60/2000	MT 70/1000	MT 70/1500	MT 70/2000		
Precio Price Prix								
Medidas Measures (mm) Mesures	1000 x 600 x 850mm.	1500 x 600 x 850mm.	2000 x 600 x 850mm.	1000 x 700 x 850mm.	1500 x 700 x 850mm.	2000 x 700 x 850mm.		
Material Material (EXT/INT) Matériel	Inox AISI 304							
Optional Options	Cajón auxiliar / Additional drawer / Tiroir 600 [CAJMT60] <b>137 €</b> Cajón auxiliar / Additional drawer / Tiroir 700 [CAJMT70] <b>147 €</b> Incremento peto mural / Increase for splash blak / Supplément dossieret mod. 1000 <b>54 €</b> Incremento peto mural / Increase for splash blak / Supplément dossieret mod. 1500 <b>79 €</b> Incremento peto mural / Increase for splash blak / Supplément dossieret mod. 2000 <b>96 €</b>							
Modelos ME / ME Models / Modèles ME: Medidas especiales consultar con fábrica / Special length measurements consult our factory / Dimensions spéciales en longueur consulter l'usine.								

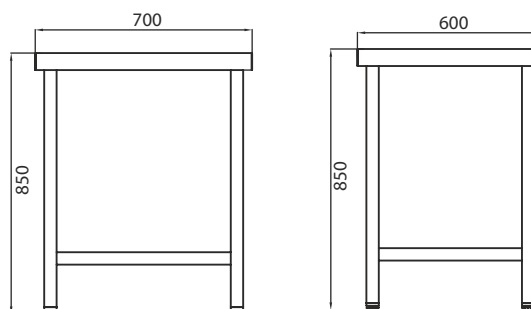
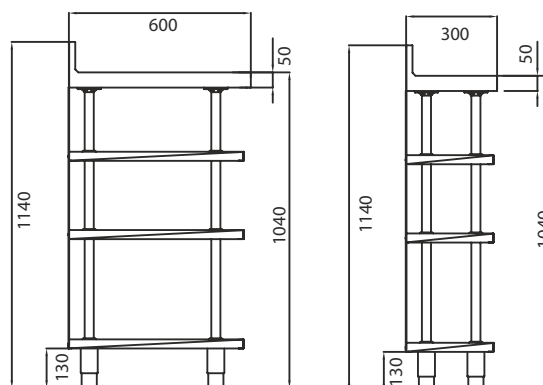



+Info: [www.infrico.com](http://www.infrico.com)



# Armarrios

Reach Ins / Armoires

3

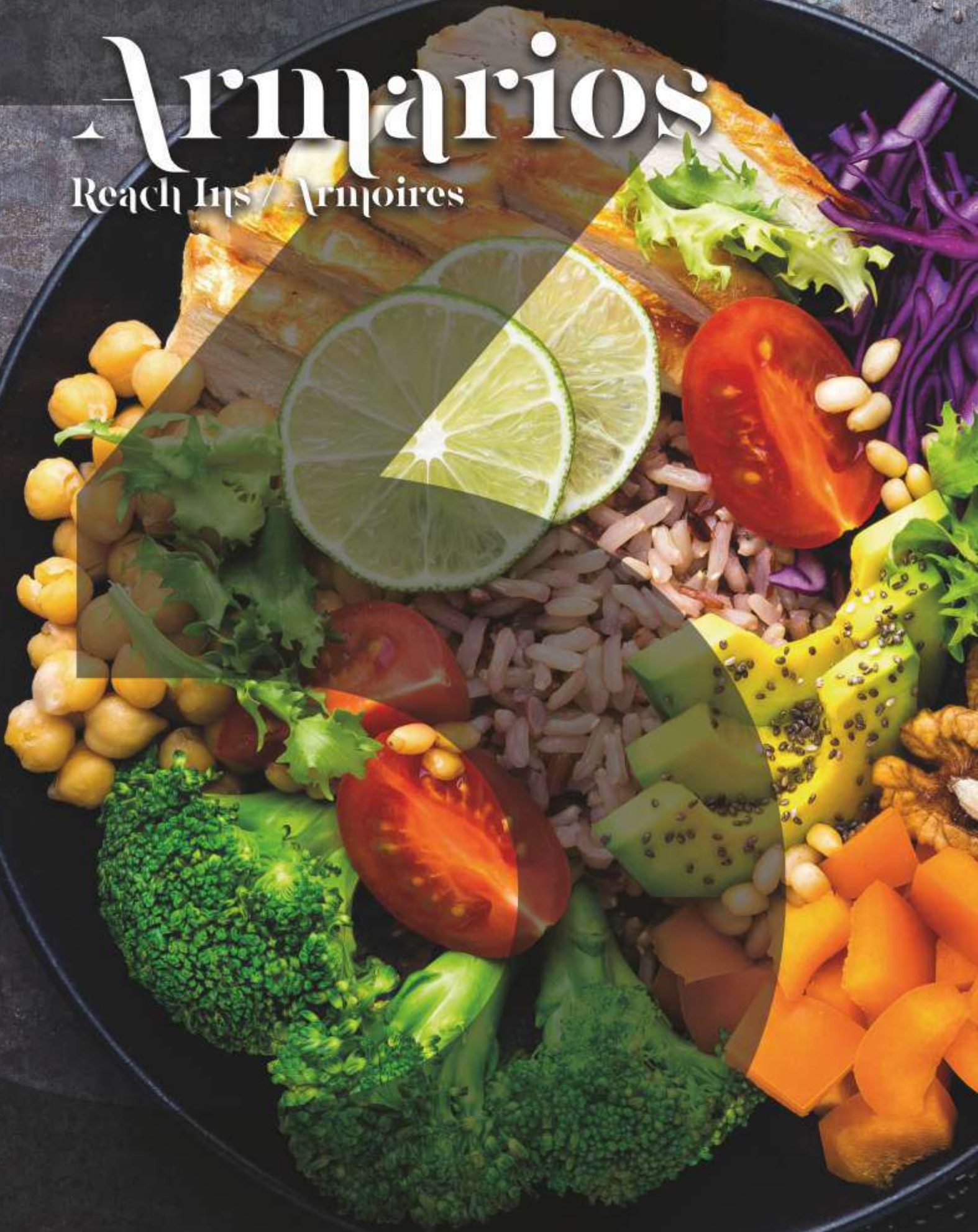



Infrico

4.0



Serie / Series / Série

# NACIONAL 400/900L

AN T/F  
AN BT  
AN CR  
AP T/F



106-109

Serie / Series / Série

# NACIONAL 500/1000L

AN T/F  
AN BT  
AN MX  
AN DP TF/G  
AN DP TF  
AEX T/F  
AN BT CR



110-115

Serie / Series / Série

# NACIONAL 1600L

AN T/F



116-117

Serie / Series / Série

# SLIM LINE 300/600L

AGN  
AGN BT  
AGN MX  
AGN CR



118-119

Serie / Series / Série

# AGB GN2/1 600/1300L

AGB  
AGB BT



120-121

Serie / Series / Série

# AGB GN2/1 700/1400L

AGB  
AGB BT  
AGB MX  
AGB CR  
AGB CR BT  
AGB PESC  
AGB A  
AGB PAST  
AGB BT PAST



122-127

Serie / Series / Série

# EURONORM 60/40-60/80 AGB900L

AGB  
AGB BT



128-129

Serie / Series / Série

# CATERING AC600L

AC R  
AC BT



128-129

Serie / Series / Série

# PROOFING FC900BT

FC BT  
FC BT CR



130-131

Serie / Series / Série

# ROLLING RIC

RIC  
RIC TH



132-133



### 3. Armarios Reach Ins / Armoires

Controlador digital táctil e intuitivo IP 65.

Digital control easy and intuitive-touch screen IP65 protection.

Contrôleur digital tactile e intuitif IP 65.



Doble acristalamiento templado, bajo emisor con carga de Argón [4-27-4].

Double tempered glass, low-e with argon charge [4-27-4].

Double vitrage et verre trempé [4-27-4].



3



#### Iluminación / Lighting / Éclairage

Incorporación de iluminación LED, llegando a reducir el consumo energético entre un 80% y 90%, respecto a una bombilla tradicional. RGB opcional.

LED lighting incorporated, reducing energetic consumption between 80% and 90% respect to a traditional lighth bulb. RGB optional.

Éclairage LED, réduisant la consommation énergétique entre 80% et 90%, par rapport à une ampoule traditionnelle. RGB optionnel.





+Info: [www.infrico.com](http://www.infrico.com)



Puertas con tirador de doble agarre y burlete plano desmontable "cleanless".  
 Double handle doors and flat gasket easily removable "cleanless".  
 Portes avec double poignée et joint plat facilement démontable "cleanless".



Opcional: Manejo del control digital por WiFi o  Bluetooth®  
 Optional: Operating digital control by WiFi or  Bluetooth®  
 Optionnel: Fonctionnement de la commande numérique par WiFi ou  Bluetooth®

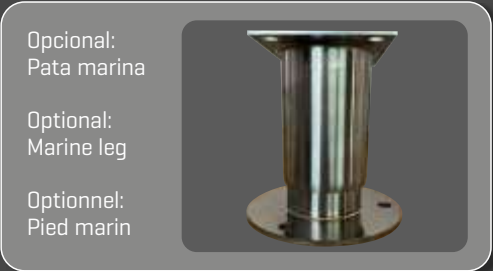

# Armarios de refrigeración y congelación Euronorm 600x400 / Euronorm 600x400 reach in refrigerator and freezer / Armoire Euronorme 600x400 positive et négative

REFRIG / REFRIG / POSIT

CONGEL / FREEZ / NÉGAT

REFRIG / REFRIG / POSIT

MODELO  
MODELE  
MODÈLE

AN 401 T/F

AN 902 T/F

AN 904 T/F

AN 401 BT

AN 902 BT

AN 401 CR

AN 902 CR

Precio Price Prix							
Medidas Measures [mm] Mesures	557 x 775 x 2060	1124 x 775 x 2060	1124 x 775 x 2060	557 x 775 x 2060	1124 x 775 x 2060	557 x 775 x 2060	1124 x 775 x 2060
Temperatura Temperature Température	-2°C/+8°C			-18°C		-2°C/+8°C	
Clase Climática Climatic class Classe climatique	5 / 40°C			4 / 38°C		5 / 40°C	
Tensión/Frecuencia Electrical data Tension électrique	230V/1ph/50Hz						
Controlador Controller Régulateur	Digital IP65						
Material Material [EXT/INT] Matériel	AISI 304						
Espesor Thickness Épaisseur	55						
Aislamiento Isolation Isolation	40kg/m <sup>3</sup> / Free CFC's / Zero ODP-GWP						
Capacidad Capacity Capacité	395	895	895	395	895	395	895
Puertas Doors Portes	1	2	4	1	2	1	2
Nº parrillas / Guías Nº shelves / Slides Nº de grilles / Glissière	3/3 [600x400]	6/6 [600x400]		3/3 [600x400]	6/6 [600x400]	3/3 [600x400]	6/6 [600x400]
Sistema de frío Cooling System Système de froid	Forzado / Forced air / Ventilé						
Desescarche Defrost Dégivrage	Parada de compresor / Compresor off / Arrêt du compresseur			Gas caliente / Hot gas / Gaz chaud		Parada de compresor / Compresor off / Arrêt du compresseur	
Expansión Expansion Expansion	Capilar / Capillary / Capillaire			Válvula termostática / Expansion valve / Détendeur thermostatique		Capilar / Capillary / Capillaire	
Potencia Power Puissance	250	410		607	771	250	410
Potencia frig. Cooling capacity Puissance Frig.	370	690		540	720	370	690
Consumo Consumption Consommation	1,55	1,90		5,10	9,51	-	-
Clase energética Energy class Classe Énerg.	<b>C</b>	<b>B</b>		<b>D</b>		-	-
Refrigerante Refrigerant Gaz	<b>R-290</b>						
Opcional Optional Options	Parrilla / Wire shelf / Grille [502X26] Juego de guías / Slides / Jeu de Glissières [GUIALO120595; GUIALO220595] Cerradura / Lock / Serrure [506X209; 506X210] Manejo control digital por bluetooth / Operating digital control by bluetooth / Trait. de contrôle digital par bluetooth						
	115V/1ph/60Hz 230V/1ph/60Hz			115V/1ph/60Hz 230V/1ph/60Hz		115V/1ph/60Hz 230V/1ph/60Hz	

**NEW**

Serie / Series / Série **NACIONAL 400/900L**

+Info: [www.infrico.com](http://www.infrico.com)

AN 904 T/F



AN 401 CR



AN 401 T/F



AN 902 BT

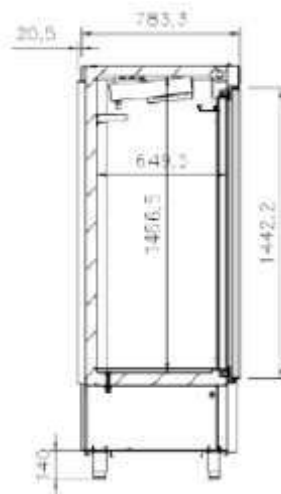

Controlador digital IP 65.  
Digital control IP65  
Contrôleur digital IP 65.



# Armarios de refrigeración y congelación Pastelería y Pescado Euronorm 600x400 / Pastry and Fish Euronorm 600x400 reach in refrigerator and freezer / Armoire Euronorme 600x400 positive et négative pour la Pâtisserie et le Poisson

PASTELERÍA / PASTRY / PÂTISSERIE

PESCADO / FISH / POISSON



MODELO  
MODELE  
MODÈLE

AN 401 PAST

AN 902 PAST

AN 401 BT PAST

AN 902 BT PAST

AP 401 T/F

AP 902 T/F

Precio Price Prix						
Medidas Measures [mm] Mesures	557 x 775 x 2060	1124 x 775 x 2060	557 x 775 x 2060	1124 x 775 x 2060	557 x 775 x 2060	1124 x 775 x 2060
Temperatura Temperature Température	<b>-2°C/+8°C</b>		<b>-18°C</b>		<b>-2°C/+2°C</b>	
Clase Climática Climatic class Classe climatique	5 / 40°C		4 / 38°C		5 / 40°C	
Tensión/Frecuencia Electrical data Tension électrique	230V/1ph/50Hz					
Controlador Controller Régulateur	Digital IP65					
Material Material [EXT/INT] Matériel	AISI 304					
Espesor Thickness Épaisseur	55					
Aislamiento Isolation Isolation	40kg/m <sup>3</sup> / Free CFC's / Zero ODP-GWP					
Capacidad Capacity Capacité	395	895	395	895	395	895
Puertas Doors Portes	1	2	1	2	1	2
Nº parrillas / Guías Nº shelves / Slides Nº de grilles / Glissière	0/18	0/36	0/18	0/36	7	14
Sistema de frío Cooling System Système de froid	Forzado / Forced air / Ventilé					
Desescarche Defrost Dégivrage	Parada de compresor / Compresor off / Arrêt du compresseur		Gas caliente / Hot gas / Gaz chaud		Parada de compresor / Compresor off / Arrêt du compresseur	
Expansión Expansion Expansion	Capilar / Capillary / Capillaire		Válvula termostática / Expansion valve / Détendeur thermostatique		Capilar / Capillary / Capillaire	
Potencia Power Puissance	250	410	607	771	250	410
Potencia frig. Cooling capacity Puissance Frig.	370	690	540	720	370	690
Consumo Consumption Consommation	1,55	1,90	5,10	9,51	1,55	1,90
Clase energética Energy class Classe Énerg.	<b>C</b>	<b>B</b>	<b>D</b>		<b>C</b>	<b>B</b>
Refrigerante Refrigerant Gaz	<b>R-290</b>					
Opcional Optional Options	Parrilla / Wire shelf / Grille [502X26] Juego de guías / Slides / Jeu de Glissières [GUAL0120595; GUAL0220595] Cerradura / Lock / Serrure [506X209; 506X210] Manejo control digital por bluetooth / Operating digital control by bluetooth / Trait. de contrôle digital par bluetooth					
	Bandeja / Tray / Plateau 600x400 [A850P41]				Contenedor polipropileno / Polypropylene container / Container polypropylène [501X08]	
	115V/1ph/60Hz 230V/1ph/60Hz		115V/1ph/60Hz 230V/1ph/60Hz		115V/1ph/60Hz 230V/1ph/60Hz	

Serie / Series / Série **NACIONAL 400/900L**  
 Serie / Series / Série **AP T/F**

+Info: [www.infrico.com](http://www.infrico.com)

AP 401 T/F



**Contenedor polipropileno**  
 Polypropylene container  
 Container polypropylène



600mm x 400mm x 150mm

AN 902 PAST



**Bandeja pastelería [opcional]**  
 Pasty tray [optional]  
 Plateau Pâtisserie [optionnel]



AN 400 PAST



Opcional: Manejo control digital por WiFi o Bluetooth®  
 Optional: Operating digital control by WiFi or Bluetooth®

**Controlador digital IP 65.**  
 Digital control IP65  
 Contrôleur digital IP 65.

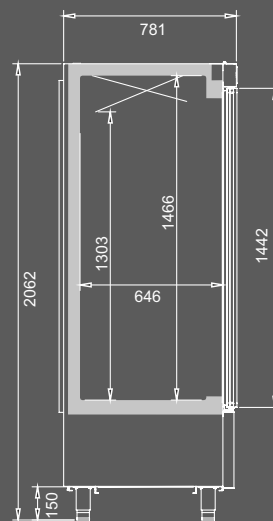

# Armarios de refrigeración y congelación / Reach in refrigerator and freezer / Armoire positive et négative

REFRIG / REFRIG / POSIT

CONGEL / FREEZ / NÉGAT

REFRIG-CONGEL / REFRIG-FREEZER / POSIT-NÉGATIVE



MODELO  
MODELE  
MODÈLE

AN 501 T/F

AN 1002 T/F

AN 501 BT

AN 1002 BT

AN 502 T/F

AN 1003 T/F

AN 1004 T/F

Precio Price Prix							
Medidas Measures [mm] Mesures	687 x 700 x 2060	1385 x 700 x 2060	687 x 700 x 2060	1385 x 700 x 2060	687 x 700 x 2060	1385 x 700 x 2060	1385 x 700 x 2060
Temperatura Temperature Température	<b>-2°C/+8°C</b>		<b>-18°C</b>		<b>-2°C/+8°C</b>		
Clase Climática Climatic class Classe climatique	5 / 40°C		4 / 38°C		5 / 40°C		
Tensión/Frecuencia Electrical data Tension électrique	230V/1ph/50Hz						
Controlador Controller Régulateur	Digital IP65						
Material Material [EXT/INT] Matériel	AISI 304						
Espesor Thickness Épaisseur	55						
Aislamiento Isolation Isolation	40kg/m <sup>3</sup> / Free CFC's / Zero ODP-GWP						
Capacidad Capacity Capacité	500	1110	500	1110	500	1110	1110
Puertas Doors Portes	1	2	1	2	2	3	4
N° parrillas / Guías N° shelves / Slides N° de grilles / Glissière	3/3 [530x460]	6/6 [530x510]	3/3 [530x460]	6/6 [530x510]	3/3 [530x460]	6/6 [530x510]	6/6 [530x510]
Sistema de frío Cooling System Système de froid	Forzado / Forced air / Ventilé						
Desescarche Defrost Dégivrage	Parada de compresor / Compresor off / Arrêt du compresseur		Gas caliente / Hot gas / Gaz chaud		Parada de compresor / Compresor off / Arrêt du compresseur		
Expansión Expansion Expansion	Capilar / Capillary / Capillaire			Válv. Expansión/ Expansion valve/ Valve d'expansion	Capilar / Capillary / Capillaire		
Potencia Power Puissance	250	415	610	795	250	420	
Potencia frig. Cooling capacity Puissance Frig.	370	690	540	720	370	690	
Consumo Consumption Consommation	1,45	2,53	5,72	10,70	1,45	2,53	
Clase energética Energy class Classe Énerg.	<b>C</b>	<b>B</b>	<b>D</b>		<b>C</b>	<b>B</b>	
Refrigerante Refrigerant Gaz	<b>R-290</b>						
Opcional Optional Options	Parrilla / Wire shelf / Grille AN 500 [502X04] Parrilla / Wire shelf / Grille AN 1000 [502X02] Juego de guías / Slides AN 500 [GUIAC0315470] Juego de guías / Slides GUIAC0115520; GUIAC0215520 Ruedas / Casters / Roulettes [705X16=2; 705X17=2]			Cerradura / Lock / Serrure Manejo control digital wifi/ Operating digital control wifi / Trait. de contrôle digital wifi Barra carnicera / Meat bar set / Barre à viande [BCAN]			
	115V/1ph/60Hz 230V/1ph/60Hz		115V/1ph/60Hz 230V/1ph/60Hz		115V/1ph/60Hz 230V/1ph/60Hz		

Serie / Series / Série **NACIONAL 500/1000L**

+Info: [www.infrico.com](http://www.infrico.com)

AN 1003 T/F



AN 501 BT



AN 1002 T/F

**Nuevo Controlador digital IP 65.**  
New Digital control IP65  
Contrôleur digital IP 65.



**Bisagra reforzada**  
Reinforced hinge  
Charnière renforcée

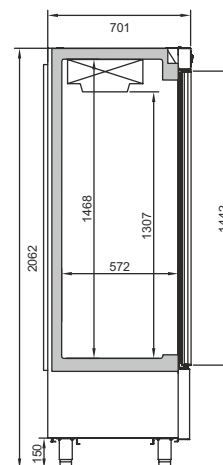
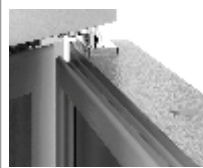

# Armarios de refrigeración, congelación y mixtos / Reach in refrigerator, freezer and dual temperature / Armoires positives, négatives et mixtes

CONGELACIÓN / FREEZER / NÉGATIVE

MIXTO / DUAL TEMP / MIXTE

PESCADO / FISH / POISSON



MODELO  
MODELE  
MODÈLE

AN502 BT

AN1003 BT

AN1004 BT

AN502 MX

AN1002 MX

ANDP1003 TF/G

ANDP1004 TF/G

ANDBT1003 TF

ANDBT1004 TF

Precio Price Prix									
Medidas Measures [mm] Mesures	687 x 700 x 2060	1385 x 700 x 2060	1385 x 700 x 2060	687 x 700 x 2060	1385 x 700 x 2060	1385 x 700 x 2060	1385 x 700 x 2060	1385 x 700 x 2060	1385 x 700 x 2060
Temperatura Temperature Température	-18°C			-2°C/+8°C -18°C		-2°C/+8°C -2°C/+2°C		-2°C/+8°C -18°C	
Clase Climática Climatic class Classe climatique	4 / 38°C					5 / 40°C		4 / 38°C	
Tensión/Frecuencia Electrical data Tension électrique	230V/1ph/50Hz								
Controlador Controller Régulateur	Digital IP65								
Material Material [EXT/INT] Matériel	AISI 304								
Espesor Thickness Épaisseur	55								
Aislamiento Isolation Isolation	40kg/m <sup>3</sup> / Free CFC's / Zero ODP-GWP								
Capacidad Capacity Capacité	500	1110		240/240	540/540	245/855			
Puertas Doors Portes	2	3	4	2		3	4	3	4
N° parrillas / Guías N° shelves / Slides N° de grilles / Glissière	3/3 (530x460)	6/6 (530x510)	6/6 (530x510)	3/3 (530x460)	6/6 (530x510)	3 Cont. 4 Parr./Shel./Gril.		6 Parr./Shel./Gril.	
Sistema de frío Cooling System Système de froid	Forzado / Forced air / Ventilé								
Desescarche Defrost Dégivrage	Gas caliente / Hot gas / Gaz chaud			Parada comp(+)/Gas caliente(-) Compresor off(+)/Hot gas(-) Arrêt compres(+)/Gaz chaud(-)		Parada de compresor / Compresor off / Arrêt du compresseur		Parada comp(+)/Gas caliente(-) Compresor off(+)/Hot gas(-) Arrêt compres(+)/Gaz chaud(-)	
Expansión Expansion Expansion	Capilar / Capillary / Capillaire	Válv. Expansión/ Expansion valve/ Détendeur thermostatique		Capilar / Capillary / Capillaire					
Potencia Power Puissance	610	795		1003	1090	589		1050	
Potencia frig. Cooling capacity Puissance Frig.	540	720		370 / 445	370 / 540	690 / 370		690 / 445	
Consumo Consumption Consommation	5,72	10,70		4,84	7,91	-	-	-	-
Clase energética Energy class Classe Énerg.	D			-	-	-	-	-	-
Refrigerante Refrigerant Gaz	R-290								
Opcional Optional Options	Parrilla / Wire shelf / Grille AN 500 [502X04] Parrilla / Wire shelf / Grille AN 1000 [502X02] Juego de guías / Slides AN 500 [GUIAC0315470] Juego de guías / Slides AN 1000 [GUIAC0115520; GUIAC0215520] Barra carnicera / Meat bar set / Barre à viande [BCAN]					Cerradura / Lock / Serrure Manejo control digital wifi / Operating digital control wifi / Trait. de contrôle digital wifi Ruedas / Casters / Roulettes [705X16=2; 705X17=2]			
	115V/1ph/60Hz 230V/1ph/60Hz					115V/1ph/60Hz 230V/1ph/60Hz		115V/1ph/60Hz 230V/1ph/60Hz	



Serie / Series / Série **NACIONAL 500/1000L**

+Info: [www.infrico.com](http://www.infrico.com)

AN 1003 BT



ANDP 1004 TF/G 

De serie: 3 contenedores de polipropileno en departamento de pescado  
Standard: 3 polypropylene containers in fish department  
Standard : 3 conteneurs en polypropylène au rayon poisson

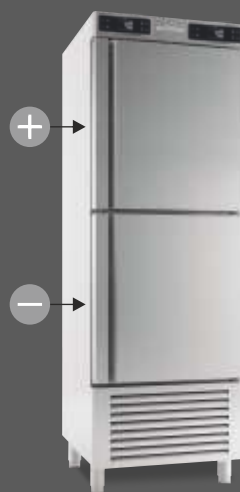

AN 502 MX

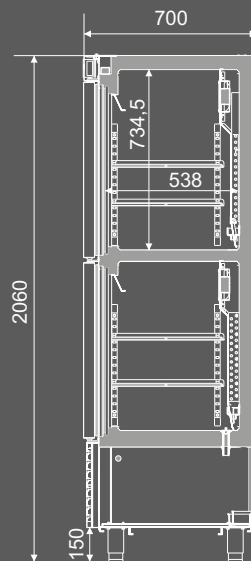

# Armarios expositores refrigeración y congelación / Bottom mounted refrigerator and freezer glass door reach in / Armoires positives et négatives portes vitrées

REFRIGERACIÓN / REFRIGERATOR / POSITIVE

CONGELACIÓN / FREEZER / NÉGATIVE

MODELO  
MODELE  
MODÈLE



AEX500 T/F



AEX1000 T/F



AEX1600 T/F



AN501 BT CR



AN1002 BT CR

Precio Price Prix					
Medidas Measures [mm] Mesures	687 x 700 x 2060 mm.	1385 x 700 x 2060 mm.	2081 x 700 x 2060 mm.	687 x 700 x 2060 mm.	1385 x 700 x 2060 mm.
Temperatura Temperature Température	+2°C/+6°C			-18°C	
Clase Climática Climatic class Classe climatique	4 / 38°C				
Tensión/Frecuencia Electrical data Tension électrique	230V/1ph/50Hz				
Controlador Controller Régulateur	Digital IP65				
Material Material [EXT/INT] Matériel	AISI 304				
Espesor Thickness Épaisseur	55				
Aislamiento Isolation Isolation	40kg/m <sup>3</sup> / Free CFC's / Zero ODP-GWP				
Capacidad Capacity Capacité	500	1110	1730	500	1110
Puertas Doors Portes	1	2	3	1	2
N° parrillas / Guías N° shelves / Slides N° de grilles / Glissière	4/4 [530x460]	8/8 [530x510]	12/12 [530x510]	4/4 [530x460]	8/8 [530x510]
Consumo Consumption Consommation [kWh/ 24h]	-	-	-	8,60	16,05
Sistema de frío Cooling System Système de froid	Forzado / Forced air / Ventilé				
Desescarche Defrost Dégivrage	Parada de compresor / Compresor off / Arrêt du compresseur			Gas caliente / Hot gas / Gaz chaud	
Expansión Expansion Expansion	Capilar / Capillary / Capillaire			Válvula de Expansión Termostática / Thermostatic expansion valve / Valve d'expansion Thermostatique	
Potencia Power Puissance [W]	270	455	615	755	1130
Potencia frig. Cooling capacity Puissance Frig. [W A -10°C]	390	690	950	723	1010
Refrigerante Refrigerant Gaz	R-290				
Opcional Optional Options	<p>Juego de guías / Slides AN 500 [GUIAC0315470]                      Juego de guías / Slides AN 1000 [GUIAC0115520; GUIAC0215520]                      Parrilla doble tupida / Dense wire shelf / Grilles AN 500 [502X90]                      Parrilla doble tupida / Dense wire shelf / Grilles AN 1000 [502X89]                      Cerradura / Lock / Serrure [506X60]                      Manejo control digital wifi / Operating digital control wifi /                      Trait. de contrôle digital wifi</p> <p>Iluminación Led RGB con cambio de color [por puerta] / Led lighting RGB                      change of colour [per door] / LED RGB avec changement de couleur [par porte]</p>				
	115V/1ph/60Hz 230V/1ph/60Hz			115V/1ph/60Hz 230V/1ph/60Hz	

Serie / Series / Série **NACIONAL 500/1000L**

+Info: [www.infrico.com](http://www.infrico.com)

**AEX 1000 T/F**



**AN 501 BT CR**

**Triple acristalamiento templado, bajo emisivo con carga de Argón [4-12-3-12-4]**  
**Triple tempered glass, low emission with Argon charge [4-12-3-12-4]**  
**Triple vitrage trempé à faible émissivité avec Argon [4-12-3-12-4]**

**Parrilla reforzada**  
**Reinforced shelves**  
**Grille renforcée**



**Nuevo Controlador digital IP 65.**  
**New Digital control IP65**  
**Contrôleur digital IP 65.**

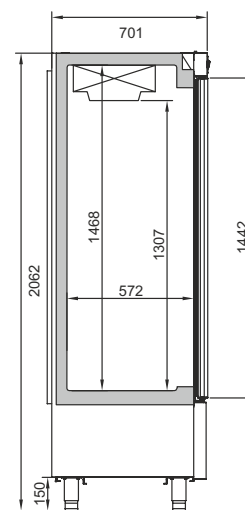

# Armario de refrigeración / Bottom mounted refrigerator / Armoire positive

# Armario de refrigeración GN1/1 / GN1/1 Reach in refrigerator / Armoire positive GN1/1

Serie / Series / Série **NACIONAL 1600L**

Serie / Series / Série **SLIM LINE 300/600L**

MODELO  
MODELE  
MODÈLE



AN1603 T/F



AN1605 T/F



AN1606 T/F



AGN301



AGN602

Precio Price Prix					
Medidas Measures [mm] Mesures	↔ ↕	2081 x 700 x 2060 mm.	2081 x 700 x 2060 mm.	2081 x 700 x 2060 mm.	482 x 695 x 2100 mm.
Temperatura Temperature Température	[°C]	-2°C/+8°C			-2°C/+8°C
Clase Climática Climatic class Classe climatique	[°C]	5 / 40°C			5 / 40°C
Tensión/Frecuencia Electrical data Tension électrique		230V/1ph/50Hz			
Controlador Controller Régulateur		Digital IP65			
Material Material [EXT/INT] Matériel		AISI 304			
Espesor Thickness Épaisseur	[mm]	55			
Aislamiento Isolation Isolation	[mm]	40kg/m <sup>3</sup> / Free CFC's / Zero ODP-GWP			
Capacidad Capacity Capacité	[L]	1730		325	745
Puertas Doors Portes		3	5	6	1
N° parrillas / Guías N° shelves / Slides N° de grilles / Glissière		9/9 (530x510)		3/3 (325x530)	6/6 (325x530)
Sistema de frío Cooling System Système de froid		Forzado / Forced air / Ventilé			
Desescarche Defrost Dégivrage		Parada de compresor / Compresor off / Arrêt du compresseur			
Expansión Expansion Expansion		Capilar / Capillary / Capillaire			
Potencia Power Puissance	[W]	420		237	402
Potencia frig. Cooling capacity Puissance Frig.	[W A -10°C]	690		370	690
Consumo Consumption Consommation	[kWh/ 24h]	3,60		1,40	1,85
Clase energética Energy class Classe Énerg.		B		C	
Refrigerante Refrigerant Gaz		R-290			
Opcional Optional Options		Juego de guías / Slides / Jeu de Glissières [GUIAC0115520; GUIAC0215520] Cerradura / Lock / Serrure [506X209; 506X210]		Manejo control digital bluetooth o wifi / Operating digital control bluetooth or wifi / Trait. de contrôle digital bluetooth ou wifi Ruedas/Casters/Roulettes [705X16=2; 705X17=2]	
		Parrilla / Wire shelf / Grille AN 1600 [502X04] Barra carnicera / Meat bar set / Barre à viande [BCAN]		Parrilla / Wire shelf / Grille [502X12]	
		115V/1ph/60Hz 230V/1ph/60Hz			

Serie / Series / Série **NACIONAL 1600L**  
 Serie / Series / Série **SLIM LINE 300/600L**

+Info: [www.infrico.com](http://www.infrico.com)



AN 1606 T/F

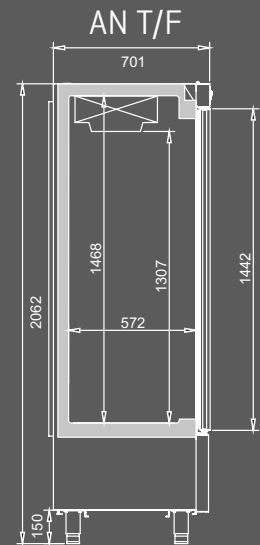

AGN 301



AGN 602

Controlador digital IP 65.  
 Digital control IP65  
 Contrôleur digital IP 65.



Opcional: Manejo control digital por WiFi o  Bluetooth®  
 Optional: Operating digital control by WiFi or  Bluetooth®

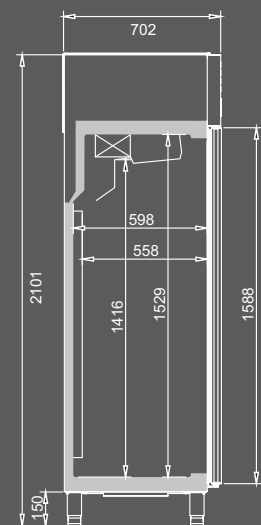

# Armarios de refrigeración y congelación GN1/1 / GN1/1 Refrigerator and freezer reach in / Armoires positives et négatives GN1/1

CONGELACIÓN / FREEZER / NÉGATIVE

REFRIGERACIÓN / REFRIGERATOR / POSITIVE

REFRIG/REFRIG/POSIT



MODELO  
MODELE  
MODÈLE

AGN301 BT

AGN602 BT

AGN602 MX

AGN302

AGN603

AGN604

AGN300 CR

AGN600 CR

Precio Price Prix								
Medidas Measures [mm] Mesures	482 x 695 x 2100 mm.	974 x 695 x 2100 mm.	974 x 695 x 2100 mm.	482 x 695 x 2100 mm.	974 x 695 x 2100 mm.	974 x 695 x 2100 mm.	482 x 695 x 2100 mm.	974 x 695 x 2100 mm.
Temperatura Temperature Température	<b>-18°C</b>		<b>-2°C/+8°C -18°C</b>	<b>-2°C/+8°C</b>			<b>+2°C/+6°C</b>	
Clase Climática Climatic class Classe climatique	4 / 38°C			5 / 40°C			4 / 38°C	
Tensión/Frecuencia Electrical data Tension électrique	230V/1ph/50Hz							
Controlador Controller Régulateur	Digital IP65							
Material Material [EXT/INT] Matériel	AISI 304							
Espesor Thickness Épaisseur	55							
Aislamiento Isolation Isolation	40kg/m <sup>3</sup> / Free CFC's / Zero ODP-GWP							
Capacidad Capacity Capacité	325	745	325+325	325	745		325	745
Puertas Doors Portes	1	2		2	3	4	1	2
Nº parrillas / Guías Nº shelves / Slides Nº de grilles / Glissière	3/3 (325x530)	6/6 (325x530)		3/3 (325x530)	6/6 (325x530)		4/4 (325x530)	8/8 (325x530)
Sistema de frío Cooling System Système de froid	Forzado / Forced air / Ventilé							
Desescarche Defrost Dégivrage	Gas caliente / Hot gas / Gaz chaud		Parada comp[+] Gas caliente[-] Compresor off[+] Hot gas[-] Arrêt compres[+] Gaz chaud[-]	Parada de compresor / Compressor off / Arrêt du compresseur				
Expansión Expansion Expansion	Válv. Expansión/ Expansion valve/ Détendeur thermostatique		Capilar[+] V. Exp[-] Cap[+] Exp. valve[-] Cap[+] V. d'exp[-]	Capilar / Capillary / Capillaire				
Potencia Power Puissance	550	725	772	237	406		252	456
Potencia frig. Cooling capacity Puissance Frig.	445	720	370 / 445	370	690		370	690
Consumo Consumption Consommation	4,83	9,22	-	1,40	1,85		-	
Clase energética Energy class Classe Energ.	<b>D</b>		-	<b>C</b>			-	
Refrigerante Refrigerant Gaz	<b>R-290</b>							
Opcional Optional Options	230V/1ph/60Hz		Manejo control digital bluetooth o wifi / Operating digital control bluetooth or wifi / Trait. de contrôle digital bluetooth ou wifi			Juego de guías / Slides / Jeu de Glissières (GUIACO115550; GUIACO215550)		
	115V/1ph/60Hz			115V/1ph/60Hz				
	Parrilla / Wire shelf / Grille (502X12) Ruedas / Casters / Roulettes (705X16=2; 705X17=2) Cerradura / Lock / Serrure (506X209; 506X210)		Parrilla inoxidable / Stainless steel wire shelf / Grille Inox (502X46) Cerradura / Lock / Serrure (506X209; 506X210) Parrilla tupida / Extradense wire shelf / Grille renforcée (502X62) Ruedas / Casters / Roulettes (705X16=2; 705X17=2)			Parrilla tupida / Extradense wire shelf / Grille renforcée (502X62) Parrilla inox / Stainless steel wire shelf / Grille Inox (502X46) Cerradura/Lock/Serrure (506X60) Iluminación Led RGB con cambio de color (por puerta) / Led lighting RGB change of colour [per door] / LED RGB avec change- ment de couleur [par porte]		

Serie / Series / Série **SLIM LINE 300/600L**

+Info: [www.infrico.com](http://www.infrico.com)

AGN 301 BT



AGN 604



AGN 600 CR

**Doble acristalamiento templado, bajo emisivo con carga de Argón [4-27-4]**  
 Double tempered glass, low emission with Argon charge [4-27-4]  
 Double vitrage trempé à faible émissivité avec Argon [4-27-4]

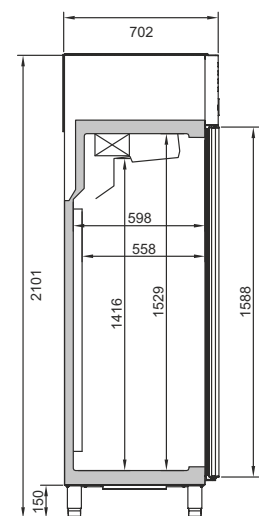

# Armarios de refrigeración y congelación GN2/1 / GN2/1 Refrigerator and freezer reach in / Armoires positives et négatives GN2/1



AGB651



AGB1302



AGB651 BT



AGB1302 BT

MODELO MODELE MODÈLE	AGB651	AGB1302	AGB651 BT	AGB1302 BT
Precio Price Prix				
Medidas Measures [mm] Mesures	687 x 794 x 1989 mm.	1385 x 794 x 1989 mm.	687 x 794 x 1989 mm.	1385 x 794 x 1989 mm.
Temperatura Temperature Température	<b>-2°C/+8°C</b>		<b>-18°C</b>	
Clase Climática Climatic class Classe climatique	5 / 40°C		4 / 38°C	
Tensión/Frecuencia Electrical data Tension électrique	230V/1ph/50Hz			
Controlador Controller Régulateur	Digital IP65			
Material Material [EXT/INT] Matériel	AISI 304			
Espesor Thickness Épaisseur	75			
Aislamiento Isolation Isolation	40kg/m <sup>3</sup> / Free CFC's / Zero ODP-GWP			
Capacidad Capacity Capacité	505	1120	505	1120
Puertas Doors Portes	1	2	1	2
N° parrillas / Guías N° shelves / Slides N° de grilles / Glissière	3 [530x650]	6 [530x650]	3 [530x650]	6 [530x650]
Sistema de frío Cooling System Système de froid	MONOBLOCK Forzado / Forced air / Ventilé			
Desescarche Defrost Dégivrage	Parada compres./ Compresor off/ Arrêt compres.		Gas caliente / Hot gas / Gaz chaud	
Expansión Expansion Expansion	Capilar/ Capillary / Capillaire		Válv. Expansión/ Expansion valve/ Détendeur thermostatique	
Potencia Power Puissance	210	374	664	1054
Potencia frig. Cooling capacity Puissance Frig.	370	690	583	1010
Consumo Consumption Consommation	1,41	2,40	7,12	13,11
Clase energética Energy class Classe Énerg.	<b>C</b>	<b>C</b>	<b>D</b>	<b>D</b>
Refrigerante Refrigerant Gaz	<b>R-290</b>			
Opcional Optional Options	Manejo control digital bluetooth o wifi / Operating digital control bluetooth or wifi / Trait. de contrôle digital bluetooth ou wifi Parrilla tupida / Extradense wire shelf / Grille renforcée [502X91] Ruedas / Casters / Roulettes [705X16=2; 705X17=2]			
	115V/1ph/60Hz		115V/1ph/60Hz	
	230V/1ph/60Hz		230V/1ph/60Hz	



Serie / Series / Série **AGB 600/1300L**

+Info: [www.infrico.com](http://www.infrico.com)

AGB 1302 BT



Medida para pasar bajo puertas estándar  
Measurement to pass under standard doors  
Mesure pour passer sous les portes standard

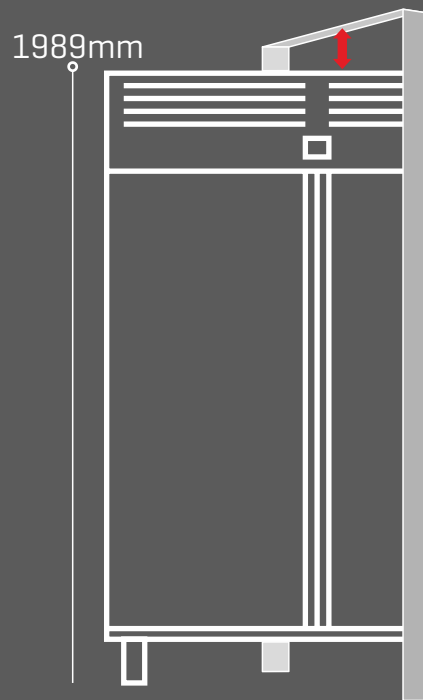

AGB 651

**Cerradura de serie**  
Door lock included  
Serrure de série

**Costados con guías embutidas**  
End pannels with embedded rails  
Joues avec rails emboutis



**Monoblock**

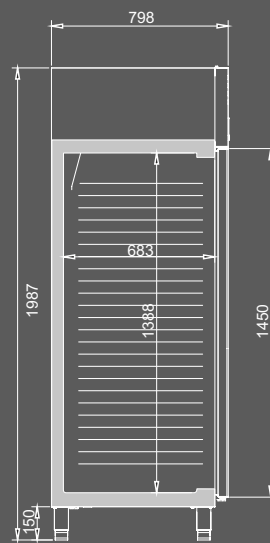

# Armarios de refrigeración y congelación GN2/1 / GN2/1 Refrigerator and freezer reach in / Armoires positives et négatives GN2/1

REFRIGERACIÓN-CONGELACIÓN / REFRIGERATOR-FREEZER / POSITIVE-NÉGATIVE



MODELO  
MODELE  
MODÈLE

AGB701

AGB1402

AGB701 BT

AGB1402 BT

AGB702

AGB702 BT

AGB1403

AGB1404

Precio Price Prix								
Medidas Measures [mm] Mesures	687 x 794 x 2130 mm.	1385 x 794 x 2130 mm.	687 x 794 x 2130 mm.	1385 x 794 x 2130 mm.	687 x 794 x 2130 mm.	687 x 794 x 2130 mm.	1385 x 794 x 2130 mm.	1385 x 794 x 2130 mm.
Temperatura Temperature Température	<b>-2°C/+8°C</b>		<b>-18°C</b>		<b>-2°C/+8°C</b>		<b>-18°C</b>	
Clase Climática Climatic class Classe climatique	5 / 40°C		4 / 38°C		5 / 40°C		4 / 38°C	
Tensión/Frecuencia Electrical data Tension électrique	230V/1ph/50Hz							
Controlador Controller Régulateur	Digital IP65							
Material Material [EXT/INT] Matériel	AISI 304							
Espesor Thickness Épaisseur	75							
Aislamiento Isolation Isolation	40kg/m <sup>3</sup> / Free CFC's / Zero ODP-GWP							
Capacidad Capacity Capacité	560	1240	560	1240	560		1240	
Puertas Doors Portes	1	2	1	2	2		3	4
N° parrillas / Guías N° shelves / Slides N° de grilles / Glissière	3 [530x650]	6 [530x650]	3 [530x650]	6 [530x650]	3 [530x650]		6 [530x650]	
Sistema de frío Cooling System Système de froid	MONOBLOCK Forzado / Forced air / Ventilé							
Desescarche Defrost Dégivrage	Parada compres./ Compresor off/ Arrêt compres.		Gas caliente / Hot gas / Gaz chaud		Parada compres./ Compresor off/ Arrêt compres.		Gas caliente / Hot gas / Gaz chaud	
Expansión Expansion Expansion	Capilar/ Capillary / Capillaire		Válv. Expansión/ Expansion valve/ Détendeur thermostatique		Capilar/ Capillary / Capillaire		Válv. exp. Termostát./ Thermost. exp. valve/ Détendeur thermos.	
Potencia Power Puissance	210	374	664	1054	210	664	371	
Potencia fríg. Cooling capacity Puissance Frig.	370	690	583	1010	370	583	690	
Consumo Consumption Consommation	1,54	2,55	7,80	13,92	1,54	7,80	2,55	
Clase energética Energy class Classe Énerg.	<b>C</b>	<b>B</b>	<b>D</b>		<b>C</b>	<b>D</b>	<b>B</b>	
Refrigerante Refrigerant Gaz	<b>R-290</b>							
Opcional Optional Options	Parrilla tupida / Extradense wire shelf / Grille renforcée [502X91] Barra carnicera / Meat bar set / Barre à viande [BCAN] Ruedas / Casters / Roulettes [705X16=2; 705X17=2] Manejo control digital bluetooth o wifi/ Operating digital control bluetooth or wifi / Trait. de contrôle digital bluetooth ou wifi							
	115V/1ph/60Hz 230V/1ph/60Hz		115V/1ph/60Hz 230V/1ph/60Hz		115V/1ph/60Hz 230V/1ph/60Hz	115V/1ph/60Hz 230V/1ph/60Hz	115V/1ph/60Hz 230V/1ph/60Hz	

Serie / Series / Série **AGB 700/1400L**

+Info: [www.infrico.com](http://www.infrico.com)

AGB 1404



**Nuevo Controlador digital IP 65.**  
New Digital control IP65  
Contrôleur digital IP 65.



AGB 701



AGB 702 BT



Opcional: Manejo control digital por WiFi o Bluetooth

Optional: Operating digital control by WiFi or Bluetooth



**Monoblock**



**Costados embutidos**  
Stamped inner sides  
Intérieurs emboutis



**Parrillas reforzadas**  
Reinforced wire shelves  
Grilles renforcées

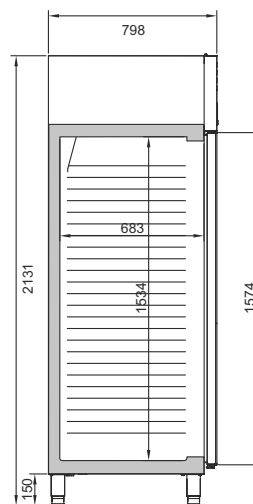

**Armarios de refriger. congel. y mixtos GN2/1 /**  
**GN2/1 Refrig, freezer and dual temp. reach in /**  
**Armoires positives, négatives et mixtes GN2/1**

**Armarios de refriger. pescado 600x400 /**  
**600x400 Fish refrigerator reach in /**  
**Armoire positives 600x400 poisson**

MIXTO / DUAL TEMP / MIXTE

REFRIG-CONGEL / REFRIG-FREEZER / POSIT-NÉGATIVE

PESCADO / FISH / POISSON



MODELO  
 MODELE  
 MODÈLE

AGN702 MX

AGB1402 MX

AGB701 CR

AGB1402 CR

AGB701 BT CR

AGB1402 BT CR

AGB701 PESC

AGB1402 PESC

Precio Price Prix									
Medidas Measures [mm] Mesures	687 x 794 x 2130 mm.	1385 x 794 x 2130 mm.	687 x 794 x 2130 mm.	1385 x 794 x 2130 mm.	687 x 794 x 2130 mm.	1385 x 794 x 2130 mm.	687 x 794 x 2130 mm.	1385 x 794 x 2130 mm.	
Temperatura Temperature Température	<b>-2°C/+8°C</b> <b>-18°C</b>		<b>-2°C/+6°C</b>		<b>-18°C</b>		<b>-2°C/+2°C</b>		
Clase Climática Climatic class Classe climatique	4 / 38°C						5 / 40°C		
Tensión/Frecuencia Electrical data Tension électrique	230V/1ph/50Hz								
Controlador Controller Régulateur	Digital IP65								
Material Material [EXT/INT] Matériel	AISI 304								
Espesor Thickness Épaisseur	75								
Aislamiento Isolation Isolation	40kg/m <sup>3</sup> / Free CFC's / Zero ODP-GWP								
Capacidad Capacity Capacité	260/260	560/560	560	1240	560	1240	560	1240	
Puertas Doors Portes	2	2	1	2	1	2	1	2	
Nº parrillas / Guías Nº shelves / Slides Nº de grilles / Glissière	3 [530x650]	6 [530x650]	4 [530x650]	8 [530x650]	4 [530x650]	8 [530x650]	Nº contenedores / Containers 7	Nº contenedores / Containers 14	
Sistema de frío Cooling System Système de froid	Forzado / Forced air / Ventilé	MONOBLOCK Forzado / Forced air / Ventilé							
Desescarche Defrost Dégivrage	Parada compres. (+) Gas caliente (-) Compressor off (+) Hot gas (-) Arrêt compres. (+) Gaz chaud (-)	Parada de compresor / Compressor off / Arrêt du compresseur		Gas caliente / Hot gas / Gaz chaud		Parada compres./ Compressor off/ Arrêt compres.			
Expansión Expansion Expansion	Capilar(+)/ V. Exp(-) Cap(+)/ Exp. valve(-) Cap(+)/ Dét. Th.(-)	Capilar / Capillary / Capillaire				Válv. Expansión/ Expansion valve/ Détendeur thermostatique		Capilar/ Capillary / Capillaire	
Potencia Power Puissance	680	910	372	420	699	1550	210	374	
Potencia frig. Cooling capacity Puissance Frig.	370 / 445	370 / 583	690		723	1446	370	690	
Consumo Consumption Consommation							-	1,54	2,55
Clase energética Energy class Classe Énerg.							-	<b>C</b>	<b>B</b>
Refrigerante Refrigerant Gaz	<b>R-290</b>								
Opcional Optional Options	Manejo control digital bluetooth o wifi / Operating digital control bluetooth or wifi / Trait. de contrôle digital bluetooth ou wifi				115V/1ph/60Hz				
	Ruedas / Casters / Roulettes (705X16=2; 705X17=2)				230V/1ph/60Hz				
	Parrilla / Wire shelf / Grille [502X91]		Parrilla / Wire shelf / Grille [502X91]				Juego de guías / Slides / Jeu de Glissières [GUIAL0125641; GUIAL0225641]		
	Ruedas / Casters / Roulettes (705X16=2; 705X17=2)		Parrilla inoxidable / Stainless steel wire shelf / Grille Inox [502X58]				Contenedor polipropileno / Polypropylene container / Conteneur de polypropylène [501X08] [501X08]		
	Juego de guías / Slides [GUIAL0320603]		Iluminación Led RGB con cambio de color [por puerta] / Led lighting RGB change of colour [per door] / LED RGB avec changement de couleur [par porte]						
	Barra carnicera / Meat bar set / Barre à viande [BCAN]								

Serie / Series / Série **AGB 700/1400L**

+Info: [www.infrico.com](http://www.infrico.com)

**AGB 1402 BT CR**



**Controlador digital IP 65.**  
Digital control IP65  
Contrôleur digital IP 65.



**Parrillas reforzadas**  
Reinforced shelves  
Grilles renforcées

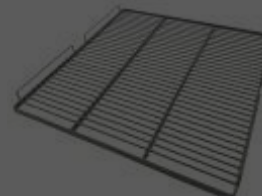

**Triple acristalamiento templado,**  
bajo emisor con carga de Argón  
(4-12-3-12-4)

Triple tempered glass, low  
emission with Argon charge  
(4-12-3-12-4)

Triple vitrage trempé à faible  
émissivité avec Argon  
(4-12-3-12-4)



**AGB PESC**

**Contenedor polipropileno**  
Polypropylene container  
Conteneur de polypropylène



**600mm x 400mm x 150mm**



**AGB 701 PESC**



## Armario refrig. GN2/1 GN2/1 refrigerator reach in / Armoire posit. GN2/1

## Armario refrig. Euronorm 600x400 Pastelería / Euronorm 600x400 pastry reach in refig. / Armoire posit. Euronorme 600x400 pâtisserie

AGB 700L INVERTER

PASTELERÍA / PASTRY / PÂTISSERIE



**A+**  
INVERTER



MODELO  
MODELE  
MODÈLE

AGB 701 A

AGB701 PAST

AGB1402 PAST

AGB701 BT PAST

AGB1402 BT PAST

Precio Price Prix					
Medidas Measures [mm] Mesures	687 x 794 x 2130 mm.	687 x 794 x 2130 mm.	1385 x 794 x 2130 mm.	687 x 794 x 2130 mm.	1385 x 794 x 2130 mm.
Temperatura Temperature Température	<b>-2°C/+8°C</b>		<b>-2°C/+8°C</b>		<b>-18°C</b>
Clase Climática Climatic class Classe climatique	5 / 40°C		5 / 40°C		4 / 38°C
Tensión/Frecuencia Electrical data Tension électrique	230V/1ph/50Hz				
Controlador Controller Régulateur	Digital IP65				
Material Material [EXT/INT] Matériel	AISI 304				
Espesor Thickness Épaisseur	75				
Aislamiento Isolation Isolation	40kg/m <sup>3</sup> / Free CFC's / Zero ODP-GWP				
Capacidad Capacity Capacité	560	560	1240	560	1240
Puertas Doors Portes	1	1	2	1	2
Nº parrillas / Guías Nº shelves / Slides Nº de grilles / Glissière	3 [530x650]	0/18	0/36	0/18	0/36
Sistema de frío Cooling System Système de froid	MONOBLOCK		Forzado / Forced air / Ventilé		
Desescarche Defrost Dégivrage	Parada compres./ Compressor off/ Arrêt compres.	Parada de compresor / Compressor off / Arrêt du compresseur		Gas caliente / Hot gas / Gaz chaud	
Expansión Expansion Expansion	Válv. de expans. Electrónica / Electronic expansion valve / Valve d'expans. Electronique	Capilar / Capillary / Capillaire		Válv. Expansión/ Expansion valve/ Détendeur thermostatique	
Potencia Power Puissance	110	210	420	683	1054
Potencia frig. Cooling capacity Puissance Frig.	334	370	690	644	1010
Consumo Consumption Consommation	0,94	1,54	2,55	7,80	13,92
Clase energética Energy class Classe Énerg.	<b>A</b>	<b>C</b>	<b>B</b>	<b>D</b>	<b>D</b>
Refrigerante Refrigerant Gaz	<b>R-600a</b>	<b>R-290</b>			
Opcional Optional Options	Manejo control digital bluetooth o wifi / Operating digital control bluetooth or wifi / Trait. de contrôle digital bluetooth ou wifi Ruedas / Casters / Roulettes [705X16=2; 705X17=2] Parrilla / Wire shelf / Grille [502X26] Juego de guías / Set of Slides / Jeu de Glissières [GUAL0120641; GUAL0220641] Bandeja / Tray / Plateau 600x400 [A850P41] Cerradura / Lock / Serrure [506X209; 506X210]				
		115V/1ph/60Hz 230V/1ph/60Hz		115V/1ph/60Hz 230V/1ph/60Hz	

+Info: [www.infrico.com](http://www.infrico.com)

AGB 701 A

Clase energ.  
Energy class  
Classe Énerg.

**A+**  
**INVERTER**



**Compresor de velocidad variable**  
Variable-capacity compressor  
Compresseur vitesse variable



**Costados embutidos**  
Stamped inner sides  
Intérieurs emboutis



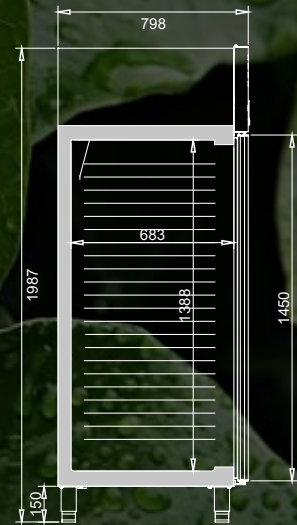

**Parrillas reforzadas**  
Reinforced wire shelves  
Grilles renforcées



36 bandejas 600x400 [no incluidas]  
36 trays 600x400 [not included]  
36 plateaux 600x400 [non inclus]

AGB 1402 BT PAST 



Opcional: Manejo control digital por WiFi o  Bluetooth®  
Optional: Operating digital control by WiFi or  Bluetooth®

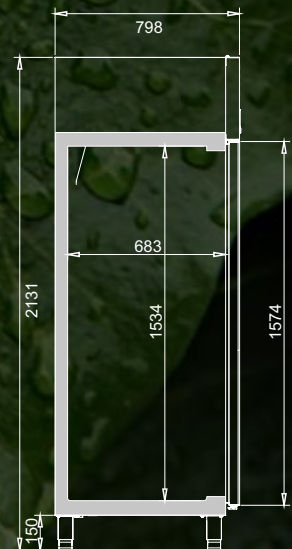

# Armarios Euronorm 800x600 pastelería-heladería / Armario Cátering

## Euronorm 800x600 pastry-ice cream reach in / Catering reach in

### Armoire Euronorme 800x600 pâtisserie-glace / Armoire traiteur catering

HELADERÍA-PASTELERÍA / ICE CREAM-PASTRY / GLACE-PÂTISSERIE

Cátering / Catering / Catering



AGB901



AGB901BT



AC600 R



AC600 BT

MODELO  
MODELE  
MODÈLE

Precio Price Prix				
Medidas Measures [mm] Mesures	796 x 960 x 2130 mm.	796 x 960 x 2130 mm.	750 x 752 x 1887 mm.	750 x 752 x 1887 mm.
Temperatura Temperature Température	-2°C/+8°C		-22°C/-25°C	
Clase Climática Climatic class Classe climatique	5 / 40°C		4 / 38°C	
Tensión/Frecuencia Electrical data Tension électrique	230V/1ph/50Hz			
Controlador Controller Régulateur	Digital IP65			
Material Material [EXT/INT] Matériel	AISI 304		AISI 430	
Espesor Thickness Épaisseur	75		60	
Aislamiento Isolation Isolation	40kg/m <sup>3</sup> / Free CFC's / Zero ODP-GWP			
Capacidad Capacity Capacité	785		542	
Puertas Doors Portes	1			
Nº parrillas / Guías Nº shelves / Slides Nº de grilles / Glissière	6/6 (600X800)		3 (600X500)	12+1 contenedores / containers / containers
Sistema de frío Cooling System Système de froid	MONOBLOCK Forzado / Forced air / Ventilé		Forzado / Forced air / Ventilé	Estático / Static / Statique
Desescarche Defrost Dégivrage	Parada compresor / Compresor off / Arrêt compresseur.	Gas caliente / Hot gas / Gaz chaud	Parada compresor / Compresor off / Arrêt compresseur.	
Expansión Expansion Expansion	Capilar/ Capillary / Capillaire	Válv. expans. Termostática / Thermostatic expans. valve/ Valv. d'expans. Thermostatique	Capilar / Capillary / Capillaire	
Potencia Power Puissance	370	680	240	230
Potencia frig. Cooling capacity Puissance Frig.	690	742	370	304
Consumo Consumption Consommation	1,60	7,95	-	
Clase energética Energy class Classe Énerg.	B		D	
Refrigerante Refrigerant Gaz	R-290			
Opcional Optional Options	115V/1ph/60Hz 230V/1ph/60Hz	115V/1ph/60Hz 230V/1ph/60Hz	115V/1ph/60Hz 230V/1ph/60Hz	115V/1ph/60Hz 230V/1ph/60Hz
	Manejo control digital bluetooth o wifi / Operating digital control bluetooth or wifi / Trait. de contrôle digital bluetooth ou wifi Parrilla / Wire shelf / Grille [502X94] Bandeja / Tray / Plateau 600x400 [A850P41] Cubeta helados 5 L. / 5 L. ice cream tray / Bacs à glace 5 L. [501X32] Cerradura / Lock / Serrure [506X209]		Parrilla / Wire shelf / Grille [502X76] Ruedas / Casters / Roulettes (705X16; 705X17 =2) Contenedor / Container / Container 500x300x180mm [501X44] Contenedor / Container 600x400x220mm [501X45]	



Serie / Series / Série **AGB 900L**  
 Serie / Series / Série **AC 600L**

+Info: [www.infrico.com](http://www.infrico.com)

AGB 901 BT



Capacidad 54 cubetas de helado de 5 L. [no incluidas]  
 Capacity 54 ice-cream 5 L. Trays [not included]  
 Capacité 54 bacs à glace 5 L. [non inclus]

AC 600 BT



Contenedor 600 x 400 mm de serie  
 Container 600 x 400 mm standard  
 Container 600 x 400 mm de série

Contenedor 500 x 300 mm de serie  
 Container 500 x 300 mm standard  
 Container 500 x 300 mm de série



AGB 901

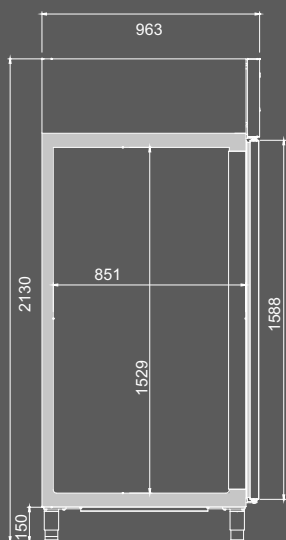

AC 600 BT

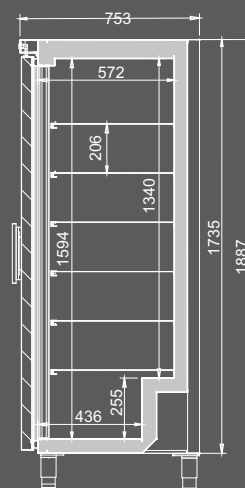

# Armario Fermentación 600x800

## Retarder proofer cabinet 600x800

### Armoire de fermentation 600x800



FC900BT



FC900BT CR

MODELO  
MODELE  
MODÈLE

Precio Price Prix		
<b>Medidas</b> Measures [mm] Mesures	↔ ↕	796 x 960 x 2130 mm.
<b>Temperatura</b> Temperature Température	[°C]	<b>-18°C/+35°C</b>
<b>Clase Climática</b> Climatic class Classe climatique	[°C]	4 / 38°C
<b>Tensión/Frecuencia</b> Electrical data Tension électrique		230V/1ph/50Hz
<b>Controlador</b> Controller Régulateur		Digital IP65
<b>Material</b> Material [EXT/INT] Matériel		AISI 304
<b>Espesor</b> Thickness Épaisseur	[mm]	75
<b>Aislamiento</b> Isolation Isolation	[mm]	40kg/m <sup>3</sup> / Free CFC's / Zero ODP-GWP
<b>Capacidad</b> Capacity Capacité	[L]	785
<b>Puertas</b> Doors Portes		1
<b>Nº parrillas / Guías</b> Nº shelves / Slides Nº de grilles / Glissière		0/20
<b>Sistema de frío</b> Cooling System Système de froid		Forzado / Forced air / Ventilé
<b>Desescarche</b> Defrost Dégivrage		Gas caliente / Hot gas / Gaz chaud
<b>Expansión</b> Expansion Expansion		Válv. expans. Termostática / Thermostatic expans. valve/ Valv. d'expans. Thermostatique
<b>Potencia</b> Power Puissance	[W]	1762
<b>Potencia frig.</b> Cooling capacity Puissance Frig.	[W A -10°C]	Frío / Cool / Froid 1600 Calor / Heat / Chauffé 750
<b>Consumo</b> Consumption Consommation	[kWh/ 24h]	-
<b>Clase energética</b> Energy class Classe Énerg.		-
<b>Refrigerante</b> Refrigerant Gaz		<b>R-290</b>
<b>Opcional</b> Optional Options		115V/1ph/60Hz 230V/1ph/60Hz
		Manejo control digital bluetooth o wifi / Operating digital control bluetooth or wifi / Trait. de contrôle digital bluetooth ou wifi Parrilla / Grate / Grille 800X600 [502X94] Parrilla / Grate / Grille 600X400 [502X26] Juego guías/Slides/Jeu Glissières [GUIAL0120806; GUIAL0220806] Cerradura/Lock/Serrure [506X209] KIT Filtro agua / Water filter / Filtre à eau [4600x0018] Bandeja 600x400/ Tray 600x400 / Plateau 600x400

Serie / Series / Série **FC 900 BT**

+Info: [www.infrico.com](http://www.infrico.com)

FC 900 BT CR



**Humidificador**  
Humidifier  
Humidificateur

**Puerto USB**  
USB Connection  
USB

**Diseño interior con cremallera y guías**  
Interior design with zip and guides  
Design intérieur avec serrure et glissières

**Resistencia aleteada en acero inox**  
Stainless steel finned heater  
Resistance à ailettes en Inox

FC 900 BT



**Opción Kit filtro de agua**  
Option Kit water filter  
Optionel Kit filtre à eau



**Video del producto**

Product Video  
Vidéo du produit



Infrico Youtube

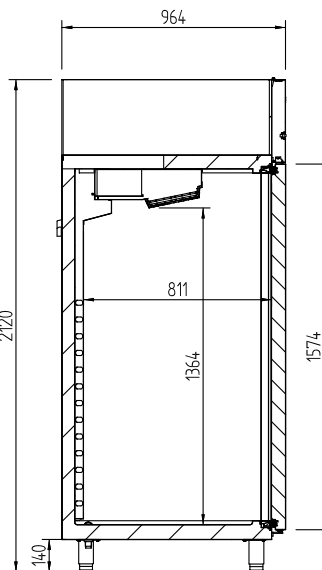

**Cambiar tiempo de fin de ciclo**  
Change end of cycle time  
Modifier la durée de fin de cycle



**Cambiar valor de temperatura**  
Change temperature setpoint  
Modifier la température de consigne



**Cambiar valor de humedad**  
Change humidity setpoint  
Modifier la valeur de l'humidité



**Armarios para carros GN2/1, 600x400, 650x450, 800x600, 1300/2700L /**  
**GN2/1, 600x400, 650x450, 800x600, 1300/2700L roll-in /**  
 Armoire à chariot GN2/1, 600x400, 650x450, 800x600, 1300/2700L



RIC1P



RIC1P BT



RIC2P



RIC1P TH  
Pasante/Pass-thru/Traversante

MODELO MODELE MODÈLE	RIC1P	RIC1P BT	RIC2P	RIC1P TH
<b>Precio</b> Price Prix				
<b>Medidas</b> Measures [mm] Mesures	876 x 1090 x 2414 mm.	876 x 1090 x 2414 mm.	2000 x 1090 x 2414 mm.	940 x 1180 x 2414 mm.
<b>Temperatura</b> Temperature Température	0°C/+8°C	-18°C	0°C/+8°C	
<b>Clase Climática</b> Climatic class Classe climatique	5 / 40°C	4 / 30°C	5 / 40°C	
<b>Tensión/Frecuencia</b> Electrical data Tension électrique	230V/1ph/50Hz			
<b>Controlador</b> Controller Régulateur	Digital IP65			
<b>Material</b> Material [EXT/INT] Matériel	AISI 304			
<b>Espesor</b> Thickness Épaisseur	80			
<b>Aislamiento</b> Isolation Isolation	40kg/m <sup>3</sup> / Free CFC's / Zero ODP-GWP			
<b>Capacidad</b> Capacity Capacité	1224	1224	2937	1245
<b>Puertas</b> Doors Portes	1	1	2	1
<b>Nº parrillas / Guías</b> Nº shelves / Slides Nº de grilles / Glissière	-			
<b>Sistema de frío</b> Cooling System Système de froid	MONOBLOCK Ventilado / Forced Air / Ventilé			
<b>Desescarche</b> Defrost Dégivrage	Parada compresor / Compresor off / Arrêt compresseur.	Gas caliente/ Hot Gas / Gaz Chaude	Parada compresor / Compresor off / Arrêt compresseur.	
<b>Expansión</b> Expansion Expansion	Capilar/ Capillary / Capillaire	Válv. expans. Termostática / Thermostatic expans. valve/ Valv. d'expans. Thermostatique	Capilar/ Capillary / Capillaire	
<b>Potencia</b> Power Puissance	380	870	760	380
<b>Potencia frig.</b> Cooling capacity Puissance Frig.	687	1011	1374	687
<b>Consumo</b> Consumption Consommation	3,90	15,6	7,4	4,86
<b>Clase energética</b> Energy class Classe Énerg.	-			
<b>Refrigerante</b> Refrigerant Gaz	R-290			
<b>Tamaño máximo Carro</b> Size maximum Rack Dimensions max. Chariot	700 x 1880 x 880 mm			
<b>Opcional</b> Optional Options	Manejo control digital bluetooth o wifi / Operating digital control bluetooth or wifi / Trait. de contrôle digital bluetooth ou wifi  Carro / Rack / Chariot (455x635x1787) GN 1/1 [CBGN2011] Carro / Rack / Chariot (660x755x1787) GN2/1 [CBGN2021] Carro / Rack / Chariot (530x705x1787) 600x400 mm [CBE20]			

Serie / Series / Série **RIC**

+Info: [www.infrico.com](http://www.infrico.com)



**RIC1PTH**  
Pasante / Pass-thru / Traversante

Nuevo Controlador digital IP 65.  
New Digital control IP65  
Contrôleur digital IP 65.



**RIC2P**



**RIC 1P BT**

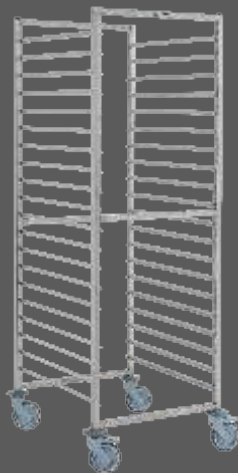

**CBGN 2011**  
**CBGN 2021**

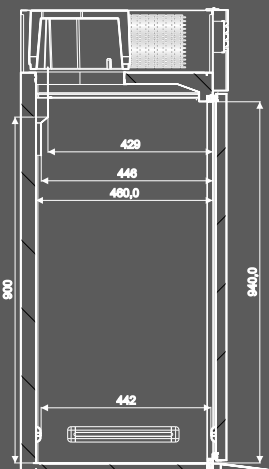

**RIC 1P/2P**

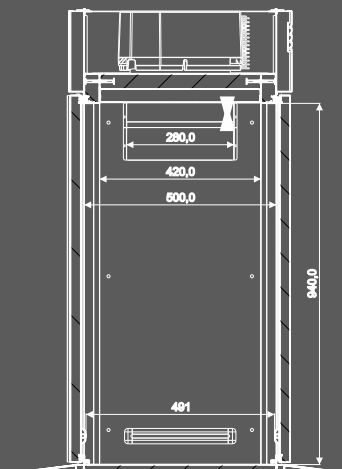

**RIC1PTH**  
Pasante/Pass-thru/Traversante





+Info: [www.infrico.com](http://www.infrico.com)



# Abatidores

Blast Chillers / Cellules de Réfrigérissement

4







## Función & Ciclos Work & Cycles Fonction et cycles

142-143

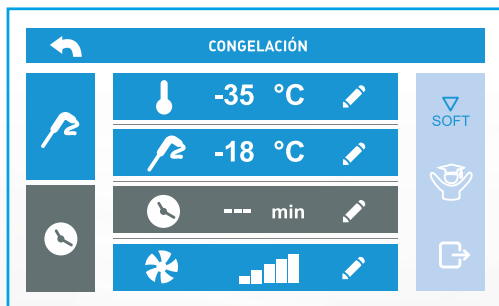

Serie / Series / Série

## 3, 5, 6, 7, 10, 14 NIVELES / LEVELS / NIVEAUX



ABT 144-145

Serie / Series / Série

## 20 NIVELES / LEVELS / NIVEAUX



ABT 146-147

Serie / Series / Série

## 20 DOBLES / DOUBLES / DOUBLES

Serie / Series / Série

## MODULAR / MODULAR / MODULAIRE



ABT 148-151

+Info: [www.infrico.com](http://www.infrico.com)



# 4. Abatidores

## Blast Chillers / Cellules de Refroidissement

Controlador táctil integrado en la puerta.  
Diseño innovador.  
USB integrado en el lateral.

Contrôleur tactile intégré dans la porte. Conception innovante.  
USB intégré sur le côté.

Touch controller integrated in the door.  
Innovative design.  
USB integrated in the side.



Refrigeración / Refrigeration / Réfrigération



**ABT5L**



**ABT71M**



**ABT101L**

Compatibles con diferentes tipos de carro.  
Compatible with different types of trolleys.  
Compatible avec différents types de chariots.

[Rational, Unox, Convothem, etc]



Rampa opcional en los modelos ABT20 [excepto S].

Optional ramp on ABT20 models [except S].

Rampe en option sur les modèles ABT20 [sauf S].



+Info: [www.infrico.com](http://www.infrico.com)

Nuevo tirador en los modelos ABT20.

New handle on ABT20 models.

Nouvelle poignée sur les modèles ABT20.



**ABT20 1CBI**



**ABT20 2P**

Nueva cuba recoge aguas en ABT20.

New water collecting tank in ABT20 model.

Nouveau bac de rétention d'eau dans le modèle ABT20.



# Función del abatidor y ciclos de trabajo

## How blast chillers work & cycle functions

## Fonction de la cellule de refroidissement et cycles de travail

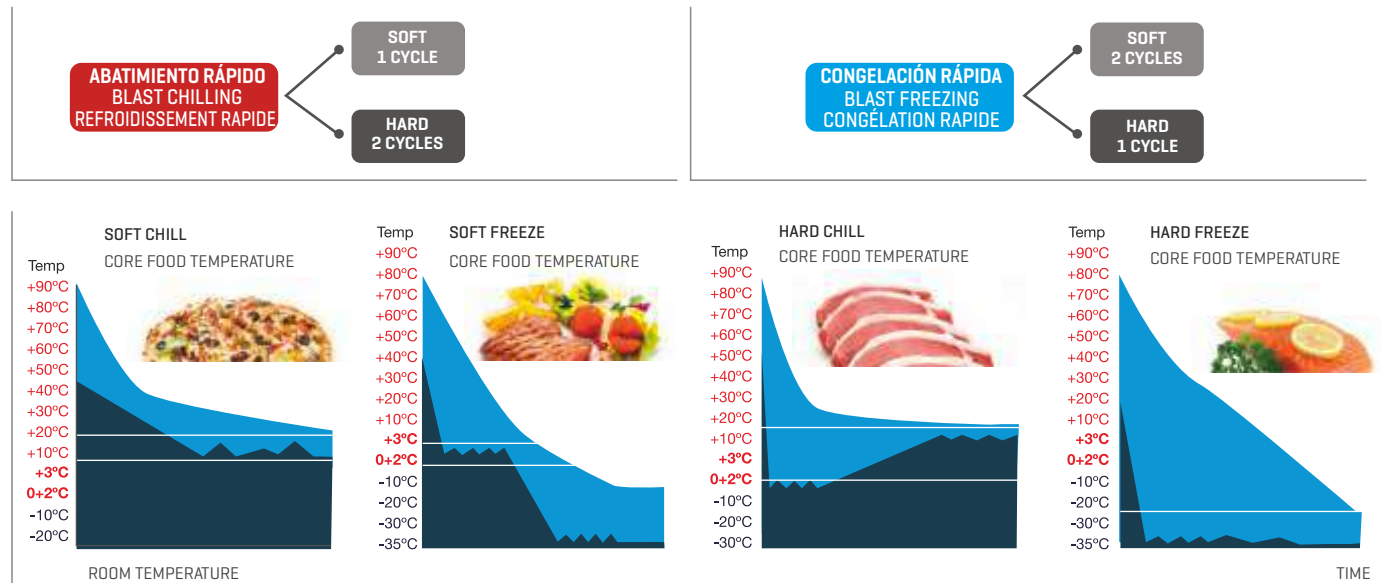

### Función de abatidor

Los abatidores permiten reducir en un tiempo muy breve la temperatura en el corazón de los alimentos, sean cocinados o frescos, conservando sus características de frescura, higiene y calidad, disminuyendo los riesgos de proliferación bacteriana.

- La manera tradicional de conservar los alimentos cocinados ha sido dejar enfriar los alimentos al aire libre hasta que la temperatura del alimento alcance una temperatura ideal para su conservación en el refrigerador.

- La fase de enfriamiento entre +65°C y +10°C es un intervalo de tiempo que compromete las características naturales del producto [humedad, consistencia, aroma, color] y lo somete a la agresión y a la consecuente proliferación bacteriana.

- Con los ABATIDORES INFRICO se persigue reducir al máximo la permanencia de los alimentos en este intervalo crítico de temperaturas.

### How blast chillers work

Blast chillers quickly reduce the core temperature of the products, whether they are cooked or fresh, conserving their fresh texture, hygiene and quality, whilst reducing the risk of bacteria generation.

- The traditional method of storing cooked food has always been to leave it to cool naturally until it reaches a suitable temperature to store in the refrigerator.

- During the period when the core temperature falls from +65°C and +10°C, the food will lose a lot of its natural characteristics, such as moisture, consistency, aroma and colour. Furthermore, this is when bacteria begin to grow.

- INFRICO BLAST CHILLERS are designed to reduce the time period for this critical change in temperature.

### Fonction cellule de ref.

Les cellules de refroidissement permettent de réduire très rapidement la température au cœur des aliments, qu'ils soient cuits ou frais, tout en conservant leurs caractéristiques de fraîcheur, d'hygiène et de qualité, et en réduisant le risque de prolifération bactérienne.

- La manière traditionnelle de conserver les aliments cuisinés est de les laisser refroidir à l'air libre jusqu'à ce que leur température atteigne une valeur idéale pour leur conservation au réfrigérateur.

- La phase de refroidissement de +65°C à +10°C est un espace de temps qui compromet les caractéristiques naturelles du produit [humidité, consistance, arôme et couleur] et l'expose à l'agression ainsi qu'à la prolifération bactérienne qui peut en suivre.

- Les CELLULES DE REFOUDDISSEMENT INFRICO, sont conçues pour réduire au maximum la permanence des aliments dans cet intervalle critique de températures.

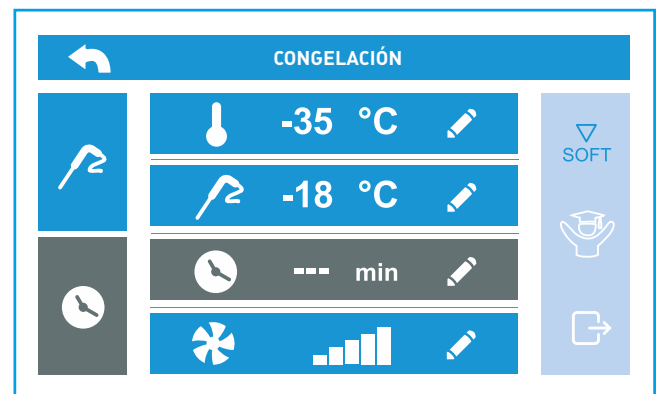
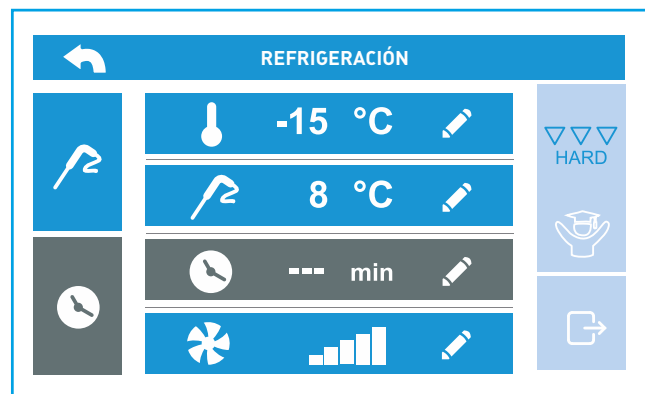

+Info: [www.infrico.com](http://www.infrico.com)

### CARACT. PRINCIPALES



Diseño elegante, ausencia de espesor y facilidad de uso.



Opción ciclos personalizados con 3 fases de regulación.



Grado de protección de la interfaz del usuario IP65.



Gestión de ciclos de abatimiento y sobrecongelación, por temperatura y por tiempo, con función "hard/soft" y gestión de la intensidad.



Gestión del test para comprobar que la sonda pincho se ha colocado correctamente [incluidas las sondas de tipo "multipoint"].



Representación gráfica en tiempo real del ciclo de abatimiento/sobrecongelación en curso.

### MAIN FEATURES

Stylish design, flush mounted, user-friendly.

Option personalized cycles with 3 regulation phases.

User interface with IP65 protection.

Management of blast chilling and freezing cycles, both temperature and time controlled, with hard/soft and intensity management functions.

Runs a test to check that the needle probe is correctly inserted [including multipoint probes].

Real-time graphic display for blast chilling/freezing cycle in progress.

### CARACT. PRINCIPALES

Lignes élégantes et faciles d'utilisation.

Option cycles personnalisés avec 3 phases de régulation.

Haute protection de l'interface de l'utilisateur IP65.

Gestion des cycles de refroidissement et de surgélation, par température et durée, avec la fonction « hard/soft » et gestion de l'intensité.

Test pour vérifier si la sonde est correctement mise [inclues les sondes de type « multipoint »].

Représentation graphique en temps réel du cycle de refroidissement et surgélation en cours.



### VENTAJAS



Sonda calefactada.



Gestión de ciclos especiales [higienización pescado, descongelación, endurecimiento helado, etc...]



Possibilidad de personalizar 99 programas.

### ADVANTAGES

Heated probe.

Management of special cycles [fish sanitation, thawing, ice cream hardening, etc.]

Possibility to personalize 99 programs

### AVANTAGES

Sonde chauffée.

Gestion des cycles spéciaux [hygiénisation du poisson, décongélation, durcissement de la glace, etc...]

Possibilité de personnaliser 99 programmes.

**Nuevos ciclos especiales como:**  
**Higienización pescado,**  
**descongelación,**  
**endurecimiento helado, etc...**

**New special cycles:**  
**Fish sanitation, ice cream**  
**hardening, etc...**

**Nouveaux cycles spéciaux**  
**comme:**  
**hygiénisation du poisson,**  
**décongélation,**  
**durcissement de la glace, etc...**

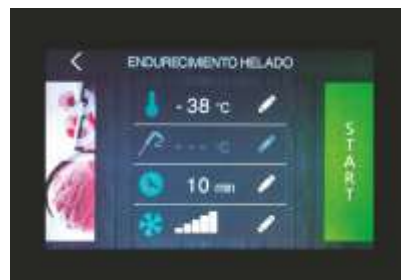
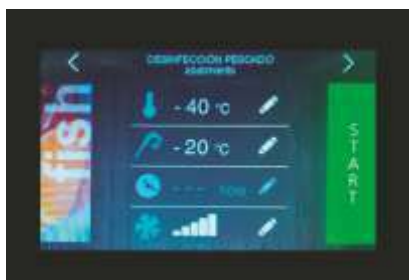

# Abatidores y congeladores de temperatura / Blast chillers and freezers / Cellule de refroidissement et surgélation

3 - 5 Niveles / Levels / Niveaux

6 - 7 Niveles / Levels / Niveaux

10 - 14 Niveles / Levels / Niveaux

MODELO  
MODELE  
MODÈLE



ABT3 1S

ABT5 1L

ABT5 1C

ABT6 1C

ABT7 1L

ABT7 1M

ABT10 1L

ABT14 1L

ABT10 2S

Precio Price Prix									
Medidas Measures [mm] Mesures	721 x 711 x 536 mm.	837 x 870 x 950 mm.	837 x 724 x 800 mm.	508 x 863 x 1059 mm.	837 x 870 x 1120 mm.	1468 x 700 x 940 mm.	837 x 870 x 1730 mm.	837 x 870 x 1730 mm.	1072 x 1076 x 1950 mm.
Temperatura Temperature Température	+3°C / -38°C								
Clase Climática Climatic class Classe climatique	4 / 38°C								
Tensión/Frecuencia Electrical data Tension électrique	220V/1ph/50Hz						380V/3ph/50Hz		
Controlador Controller Régulateur	Táctil / Touch-screen / Tactile IP65								
Material Material [EXT/INT] Matériel	AISI 304								
Espesor Thickness Épaisseur	35	65				65	65	65	
Aislamiento Isolation Isolation	40kg/m <sup>3</sup> / Free CFC's / Zero ODP-GWP								
Capacidad Capacity Capacité	68	125	95	85	160	120	315	315	640
Compresor Compressor Compresseur	1/2	1		1	1 1/4		2	2 1/2	4
Capacidad refrig./cong. Freezing capacity [Kg.] Rendement refroid./cong.	10/5*	20/12*		20/12*	30/18*		40/25*	50/30*	80/50*
Distancia entre bandejas Distance between trays Distance entre bacs	65								80
Nº Bandejas (Opcional) Trays (Optional) Nº Bacs (Option)	3 GN 1/1	5 GN 1/1 600x400	5 GN 1/1	6 GN 1/1	7 GN 1/1 600x400	7 GN 1/1	10 GN 1/1 600x400	14 GN 1/1 600x400	10 GN 2/1 800x600
Sistema de frío Cooling System Système de froid	Forzado / Forced-air / Forcé								
Desescarche Defrost Dégivrage	Parada compresor / Compressor off / Arrêt du compresseur								
Expansión Expansion Expansion	Válvula de expansión termostática / Thermostatic expansion valve / Détendeur thermostatique								
Potencia Power Puissance	761	1205	1412	1125	2409	2393	2250	2824	3517
Potencia frig. Cooling capacity Puissance Frig.	1296	1805			2609		3723	5445	9766
Opcional Optional Options	Esterilizador/Sterilizer/Stérilisateur (407x26) Registador/Recorder/Enregistreur (308x59) Bandejas inox GN 1/1 / Stainless Steel GN1/1 / Bacs Inox GN 1/1 (501x23)					Bandeja 600x400 / 600x400 trays / Bac 600x400 (A850P41) Manejo control digital bluetooth o wifi / Operating digital control bluetooth or wifi / Trait. de contrôle digital bluetooth ou wifi			
	115V/1ph/60Hz 230V/1ph/60Hz					220V/1ph/50Hz 220V/1ph/60Hz 380V/3ph/60Hz 440V/1ph/60Hz			
	Entrada bandeja / Trays entry / Entrée bac				1S 1C		1L		GN 1/1 600x400

\*Rendimientos probados según la norma EN17032  
\*Capacity tested according to EN17032 standard  
\*Rendement prouvé selon la norme EN17032



Serie / Series / Série **3 - 5 - 6 - 7 - 10 - 14**

+Info: [www.infrico.com](http://www.infrico.com)

ABT7 1M



ABT6 1C



ABT5 1L

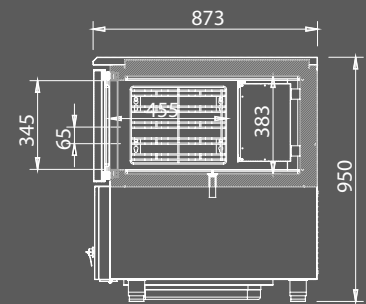

ABT10 1L



ABT10 1L

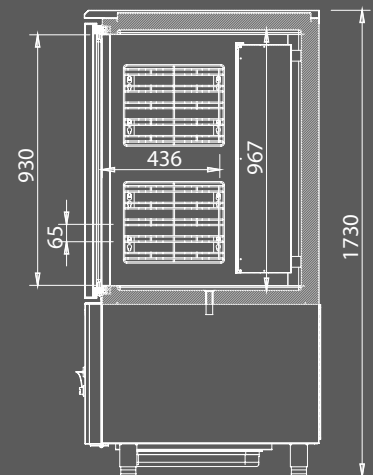

# Abatidores y congeladores de temperatura / Blast chillers and freezers / Cellule de refroidissement et surgélation



MODELO  
MODELE  
MODÈLE

ABT20 1CBI ABT20 1C ABT20 2C ABT20 1S ABT20 2S ABT20 1P ABT20 2P ABT20 2CP ABT20 2SP ABT20 2PP

Precio Price Prix										
Medidas Measures [mm] Mesures	1200 x 1125 x 2465 mm.	1200 x 1125 x 2280 mm.	1400 x 1325 x 2280 mm.	1200 x 1125 x 2280 mm.	1400 x 1325 x 2280 mm.	1200 x 1120 x 2280 mm.	1400 x 1420 x 2280 mm.	1400 x 1325 x 2280 mm.	1400 x 1325 x 2280 mm.	1400 x 1420 x 2280 mm.
Temperatura Temperature Température	+3°C / -40°C									
Clase Climática Climatic class Classe climatique	4 / 38°C									
Tensión/Frecuencia Electrical data Tension électrique	380V/3ph/50Hz									
Controlador Controller Régulateur	Táctil / Touch-screen / Tactile IP65									
Material Material [EXT/INT] Matériel	AISI 304									
Espesor Thickness Épaisseur	80									
Aislamiento Isolation Isolation	40kg/m <sup>3</sup> / Free CFC's / Zero ODP-GWP									
Capacidad Capacity Capacité	1704	1861	2747	1686	2489	1861	2747	2747	2489	2747
Capacidad refrig./cong. Freezing capacity [Kg.] Rendement refroid./cong.	110 / 60*							230 / 130*		
Tamaño máximo Carro Size maximum Rack Dimensions max. Chariot	700 x 1835 870 mm	700 x 1900 870 mm	830 x 1900 1070 mm	700 x 1700 870 mm	830 x 1700 1070 mm	700 x 1900 870 mm	830 x 1900 1070 mm	830 x 1900 1070 mm	830 x 1700 1070 mm	700 x 1900 1070 mm
Sistema de frío Cooling System Système de froid	Forzado / Forced-air / Forcé									
Desescarche Defrost Dégivrage	Parada compresor / Compressor off / Arrêt du compresseur									
Expansión Expansion Expansion	Válvula de expansión termostática / Thermostatic expansion valve / Détendeur thermostatique									
Potencia Power Puissance	6502	9773	9773	9693		9943		15343	15387	15443
Potencia frig. Cooling capacity Puissance Frig.	10073 [-10°C] / 5387 [-25°C]							20869 [-10°C] / 11411 [-25°C]		
Opcional Optional Options	Rampa / Ramp / Rampe [RAMABT21] Manejo control digital bluetooth o wifi / Operating digital control bluetooth or wifi / Trait. de contrôle digital bluetooth o wifi					Carro / Rack / Chariot [455x635x1787] GN 1/1 [CBGN2011] Carro / Rack / Chariot [660x755x1787] GN2/1 [CBGN2021] Carro / Rack / Chariot [530x705x1787] 600x400 mm [CBE20]				
	-	220V/1ph/50Hz 220V/1ph/60Hz 380V/3ph/60Hz 440V/1ph/60Hz				Opcional Condensadora ventilado axial o ventilado centrifugo o por agua Optional Condensing unit axial ventilated or centrifugal ventilated or water ventilated Options Unité de condensation à ventilation axiale ou centrifuge ou à ventilation par eau				

Motocondensadora incluida  
Condensing unit included  
Unité de condensation de série

\*Rendimientos probados según la norma EN17032  
\*Capacity tested according to EN17032 standard  
\*Rendement prouvé selon la norme EN17032

Entrada carro / Car entry / Entrée chariot

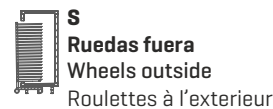
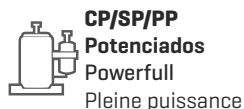

Serie / Series / Série **20**

+Info: [www.infrico.com](http://www.infrico.com)

ABT20 1S



ABT20 1CBI



Pantalla táctil de 7"  
Tactil 7" screen  
Écran tactile de 7"

**Abatimiento rápido: +90°C a +3°C en menos de 90 minutos.**  
**Congelación rápida: +90°C a -18°C en menos de 270 minutos.**  
Blas chilling: +90°C to +3°C in less than 90 minutes.  
Blast freezing: +90°C to -18°C in less than 270 minutes.  
Refroidissement rapide: +90°C à +3°C en moins de 90 minutes.  
Congélation rapide: +90°C à -18°C en moins de 270 minutes.



Modelos S compatible con carro Rational  
Models S compatible with Rational trolley  
Modèles S compatible avec chariot Rational



CBGN 2011  
CBGN 2021



ABT20 2P

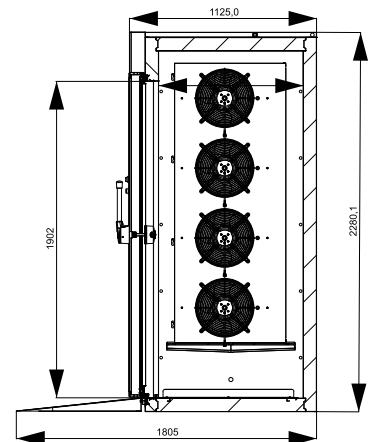

ABT20 1P



# Abatidores y congeladores de temperatura / Blast chillers and freezers / Cellule de refroidissement et surgélation



MODELO  
MODELE  
MODÈLE

ABT20 3C ABT20 4C ABT20 3P ABT20 4P ABT20 3CP ABT20 4CP ABT20 3PP ABT20 4PP

Precio Price Prix								
Medidas Measures [mm] Mesures	1200 x 2025 x 2280 mm.	1400 x 2425 x 2280 mm.	1200 x 2120 x 2280 mm.	1400 x 2520 x 2280 mm.	1200 x 2025 x 2280 mm.	1400 x 2425 x 2280 mm.	1200 x 2120 x 2280 mm.	1400 x 2520 x 2280 mm.
Temperatura Temperature Température	+3°C / -38°C							
Clase Climática Climatic class Classe climatique	4 / 38°C							
Tensión/Frecuencia Electrical data Tension électrique	380V/3ph/50Hz							
Controlador Controller Régulateur	Táctil / Touch-screen / Tactile IP65							
Material Material [EXT/INT] Matériel	AISI 304							
Espesor Thickness Épaisseur	80							
Aislamiento Isolation Isolation	40kg/m <sup>3</sup> / Free CFC's / Zero ODP-GWP							
Capacidad Capacity Capacité	3633	5388	3633	5388	3633	5388	3633	5388
Capacidad refrig./cong. Freezing capacity [Kg.] Rendement refroid./cong.	200 / 130*				400 / 260*			
Tamaño máximo Carro Size maximum Rack Dimensions max. Chariot	700 x 1900 1770 mm	830 x 1900 2170 mm	700 x 1900 1770 mm	830 x 1900 2170 mm	700 x 1900 1770 mm	830 x 1900 2170 mm	700 x 1900 1770 mm	830 x 1900 2170 mm
Sistema de frío Cooling System Système de froid	Forzado / Forced-air / Forcé							
Desescarche Defrost Dégivrage	Parada compresor / Compressor off / Arrêt du compresseur							
Expansión Expansion Expansion	Válvula de expansión termostática / Thermostatic expansion valve / Detendeur thermostatique							
Potencia Power Puissance	19546				30886			
Potencia frig. Cooling capacity Puissance Frig.	20146 [-10°C] / 11411 [-25°C]				41738 [-10°C] / 22822 [-25°C]			
Opcional Optional Options	Rampa / Ramp / Rampe [RAMABT21] Manejo control digital bluetooth o wifi / Operating digital control bluetooth or wifi / Trait. de contrôle digital bluetooth ou wifi				Carro / Rack / Chariot [660x755x1787] GN2/1 [CBGN2021] Carro / Rack / Chariot [530x705x1787] 600x400 mm [CBE20]			
	220V/1ph/50Hz 220V/1ph/60Hz 380V/3ph/60Hz 440V/1ph/60Hz				Opcional Condensadora ventilado axial o ventilado centrifugo o por agua Optional Condensing unit axial ventilated or centrifugal ventilated or water ventilated Options Unité de condensation à ventilation axiale ou centrifuge ou à ventilation par eau			

Motocondensadora incluida  
Condensing unit included  
Unité de condensation de série

\*Rendimientos probados según la norma EN17032  
\*Capacity tested according to EN17032 standard  
\*Rendement prouvé selon la norme EN17032

Entrada carro / Car entry / Entrée chariot  
**3C / 4C**  
Ruedas dentro  
Casters inside  
Roulettes à l'intérieur

**3CP / 3PP / 4CP / 4PP**  
Potenciados  
Powerfull  
Plaine puissance

**3P / 4P**  
Pasante  
Pass-throw  
Traversante

Serie / Series / Série **20 (Doble / Double / Double)**

+Info: [www.infrico.com](http://www.infrico.com)



**Pantalla táctil de 7"**  
Tactil 7" screen  
Écran tactile de 7"



ABT20 4PP



**Abatimiento rápido: +90°C a +3°C en menos de 90 minutos.**  
**Congelación rápido: +90°C a -18°C en menos de 270 minutos.**

Blast chilling: +90°C to +3°C in less than 90 minutes.

Blast freezing: +90°C to -18°C in less than 270 minutes.

Refroidissement rapide: +90°C à +3°C en moins de 90 minutes.

Congélation rapide: +90°C à -18°C en moins de 270 minutes.

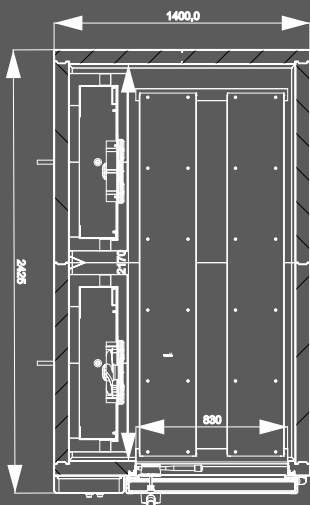

Planta / Floor plan / Plan d'étage

ABT20 4P

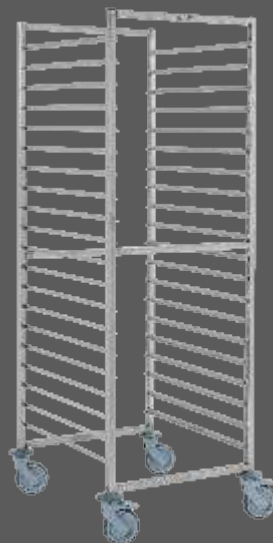

CBGN 2021 / CBGN 2011

**Motocondensadora incluida**  
Condensing unit included  
Unité de condensation de série



## Abatidores tunel modular / Modular Blast chillers / Modulaires Cellule de refroidissement et surgélation

### Abatidores Modulares

- Panel acero inox AISI 304 multiplicando por 2, 3, 4, etc, el número de carros de producto.
- Configuración de puertas pasantes en los extremos, y efecto túnel en el interior.
- Disponibles con unidades potenciadas a medida, o motocondensadoras por agua.
- Consultar proyectos a medida.

### Modular Blast Chillers

- AISI 304 stainless steel panel increasing by 2, 3, 4, etc., the number of product trolleys.
- Configuration of through doors at the entry and exit, and tunnel effect inside.
- Available with customised powered units or water condensing units.
- Consult customised projects

### Cellules de refroidissement modulaires

- Panneau en acier inoxydable AISI 304 multipliant par 2, 3, 4, etc, le nombre de chariots de produits.
- Configuration de portes traversantes à l'entrée et à la sortie, et effet tunnel à l'intérieur.
- Disponible avec des unités motorisées personnalisées ou des unités de condensation à eau.
- Consulter les projets personnalisés

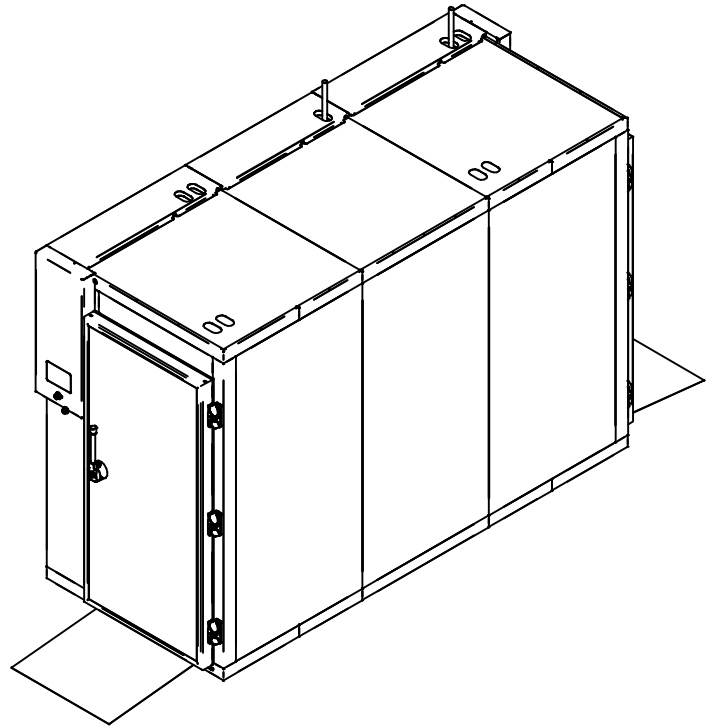

+Info: [www.infrico.com](http://www.infrico.com)



# i-line

5







Serie / Series / Série

# IABT



IABT3 1S  
IABT5 1L  
IABT10 1L \_\_\_\_\_ 158-159

Serie / Series / Série

# IEB



IEB \_\_\_\_\_ 160-161

Serie / Series / Série

# IM600



IM P  
IM PN  
IM PCR \_\_\_\_\_ 162-163

Serie / Series / Série

# IM700



IM P  
IM PN  
IM PCR \_\_\_\_\_ 164-165

Serie / Series / Série

# IF600



IF P  
IF PCR \_\_\_\_\_ 166-167

Serie / Series / Série

# IMC / IEST



IMC  
IEST \_\_\_\_\_ 168-169

Serie / Series / Série

# IAN 500/1000L



IAN  
IAN N  
IAN CR \_\_\_\_\_ 170-171

Serie / Series / Série

# IAG 700/1400L



IAG  
IAG N  
IAG CR \_\_\_\_\_ 172-173





# 5. i-Line

## Refrigeración / Refrigeration / Réfrigération

Sistemas de frío ventilado. Bandejas evaporativas sin resistencia eléctrica para una mayor eficiencia energética. Sistemas de evaporación forzada. Evaporadores tratados con Epoxi de poliéster anticorrosión. Unidades sobredimensionadas y eficientes. Válvulas de expansión termostáticas y desescarches por gas caliente en baja temperatura. Marcos de puerta calefactados para evitar acumulación de hielo.

Forced air cooling systems. Energy-saving non-electric condensate pans. Forced evaporation systems. Evaporators treated with anti-corrosion polyester Epoxy. Oversized and efficient units. Expansion valves. Hot gas defrost. Heating door frames to prevent ice build-up.

Systèmes de froid ventilé. Bacs d'évaporation sans résistances électriques pour une meilleure efficacité énergétique. Systèmes d'évaporation forcé. Évaporateurs traités avec un époxy polyester anticorrosion. Unités efficaces et surdimensionnées. Valves d'expansion thermostatiques. Dégivrache par gaz chaud. Cadres de portes chauffés pour empêcher l'accumulation de glace.



5

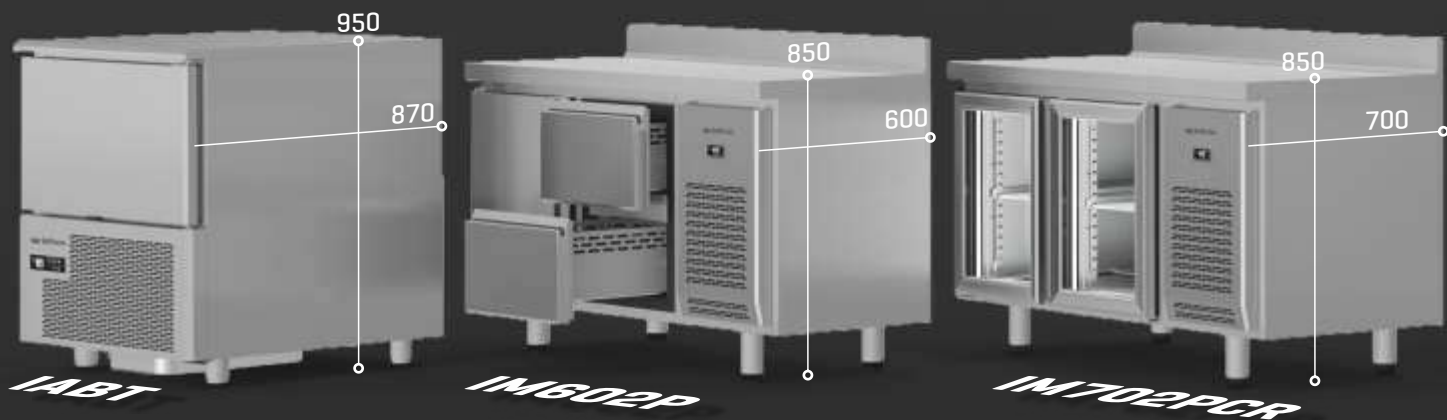

Cajones con guías telescópicas.

Drawers with telescopic guides.

Tiroirs avec glissières télescopiques.



Encimera reforzada con Omegas de serie [series 600/700].  
Reinforced worktop with Omegas as standard [600/700 series].  
Plan de travail renforcé avec Omegas en standard [séries 600/700].



+Info: [www.infrico.com](http://www.infrico.com)

Soporte de cremallera para guías.

Rack and pinion support for guides.

Support de crémaillère pour guides.



Nuevo tirador en puertas de cristal /  
New handle for glass doors /  
Nouvelle poignée sur les portes en verre

Tirador de aluminio ergonómico completo,  
integrado en el marco de puerta de cristal.

Ergonomic aluminium handle, fully integrated in  
the glass door frame.

Poignée ergonomique en aluminium,  
entièrement intégrée dans le cadre de la porte  
en verre.



Puertas con tirador embutido y burlete plano desmontable "cleanless".

Inlay doors handle and flat gasket easily removable "cleanless".

Poignée de porte encastrée et joint plat facilement démontable "cleanless".



# Abatidores y congeladores de temperatura 3, 5 y 10 niveles / Blast chillers and freezers 3, 5 & 10 levels / Cellule de refroidissement et surgélation 3, 5 et 10 niveaux

MODELO  
MODELE  
MODÈLE



IABT3 1S



IABT5 1L



IABT10 1L

Precio Price Prix			
Medidas Measures [mm] Mesures	↔ ↕	721 x 711 x 536 mm.	837 x 870 x 950 mm.  837 x 724 x 800 mm.
Temperatura Temperature Température	[°C]	<b>+3°C / -38°C</b>	
Clase Climática Climatic class Classe climatique	[°C]	4 / 38°C	
Tensión/Frecuencia Electrical data Tension électrique		220V/2ph/50Hz	380V/3ph/50Hz
Controlador Controller Régulateur		Tácti / Touch-screen / Tactile IP65	
Material Material [EXT/INT] Matériel		AISI 430	
Espesor Thickness Épaisseur	[mm]	35	65  60
Aislamiento Isolation Isolation	[mm]	40kg/m <sup>3</sup> / Free CFC's / Zero ODP-GWP	
Capacidad Capacity Capacité	[L]	68	125  485
Compresor Compressor Compresseur	[HP]	1/2	1  2
Blast chilling Freezing capacity [Kg.] Rendement refroid./cong.		10/5*	20/12*  40/25*
Distancia entre bandejas Distance between trays Distance entre bacs		65	
Nº Bandejas (Opcional) Trays (Optional) Nº Bacs (Option)		3 GN 1/1	5 GN 1/1 600x400  10 GN 1/1 600x400
Sistema de frío Cooling System Système de froid		Forzado / Forced-air / Forcé	
Desescarche Defrost Dégivrage		Parada compresor / Compressor off / Arrêt du compresseur	
Expansión Expansion Expansion		Válvula de expansión termostática / Thermostatic expansion valve / Détendeur thermostatique	
Potencia Power Puissance	[W]	761	1205  3498
Potencia frig. Cooling capacity Puissance Frig.	[W A -10°C]	1296	1805  4299
Opcional Optional Options		Esterilizador/Sterilizer/Stérilisateur (407x26) Registador/Recorder/Enregistreur (308x59) Bandejas inox GN 1/1 / Stainless Steel GN1/1 / Bacs Inox GN 1/1 (501x23) Bandeja 600x400 / 600x400 trays / Bac 600x400 (A850P41)	

Entrada bandeja /  
Trays entry /  
Entrée bac

1S 1C  
GN 1/1

1L 1L  
GN 1/1  
600x400

**\*Rendimientos probados según la norma EN17032**  
\*Capacity tested according to EN17032 standard  
\*Rendement prouvé selon norme EN17032

Serie / Series / Série **IABT**

+Info: [www.infrico.com](http://www.infrico.com)

IABT10 1L

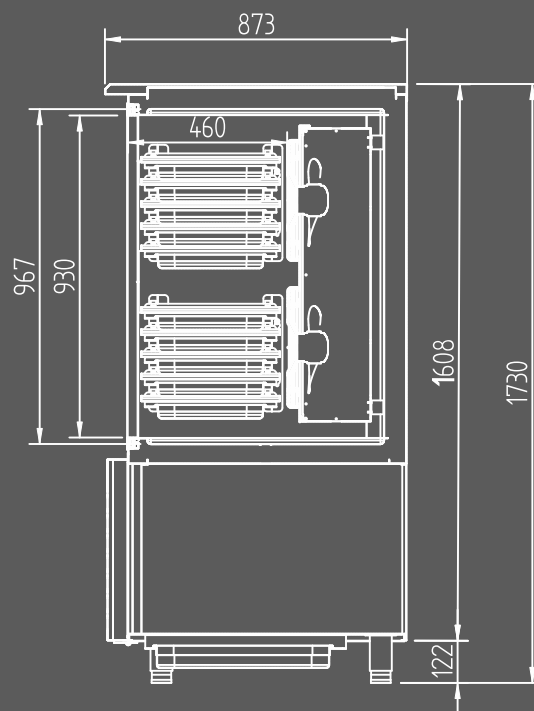

IABT10 1L

IABT5 1L

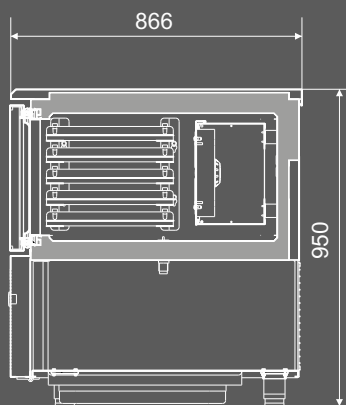

IABT5 1L

# Refrigerador de botellas / Chest bottle cooler / Refrigerateur de bouteilles

MODELO  
MODELE  
MODÈLE



IEB 100



IEB 150



IEB 200

MODELO MODELE MODÈLE	IEB 100	IEB 150	IEB 200
<b>Precio</b> Price Prix			
<b>Medidas</b> Measures [mm] Mesures	1004 x 550 x 865 mm.	1479 x 550 x 865 mm.	1954 x 550 x 865 mm.
<b>Temperatura</b> Temperature Température	<b>+3°C/+6°C</b>		
<b>Clase Climática</b> Climatic class Classe climatique	4 / 38°C		
<b>Tensión/Frecuencia</b> Electrical data Tension électrique	230V/1ph/50Hz		
<b>Controlador</b> Controller Régulateur	-		
<b>Material</b> Material [EXT/INT] Matériel	AISI 430		
<b>Espesor</b> Thickness Épaisseur	40		
<b>Aislamiento</b> Isolation Isolation	40kg/m <sup>3</sup> / Free CFC's / Zero ODP-GWP		
<b>Capacidad</b> Capacity Capacité	265	445	620
<b>Puertas</b> Doors Portes	2	3	4
<b>N° parrillas / Guías</b> N° shelves / Slides N° de grilles / Glissière	-		
<b>Sistema de frío</b> Cooling System Système de froid	Forzado / Forced air / Ventilé		
<b>Desescarche</b> Defrost Dégivrage	-		
<b>Expansión</b> Expansion Expansion	Capilar / Capillary / Capillaire		
<b>Potencia</b> Power Puissance	122	180	
<b>Potencia frig.</b> Cooling capacity Puissance Frig.	169	370	
<b>Consumo</b> Consumption Consommation	-		
<b>Clase energética</b> Energy class Classe Énerg.	-		
<b>Refrigerante</b> Refrigerant Gaz	<b>R-600a</b>	<b>R-290</b>	
<b>Opcional</b> Optional Options	-		



Serie / Series / Série **IEB**

+Info: [www.infrico.com](http://www.infrico.com)



# Mesas refrigeración, congelación y puertas de cristal / Refrigerated counters, freezers and glass doors / Dessertes positives et négatives

MODELO MODELE MODÈLE									
----------------------------	---	---	---	---	---	--	---	---	---

Precio Price Prix									
Medidas Measures [mm] Mesures	1468 x 600 x 850 mm.	1960 x 600 x 850 mm.	2452 x 600 x 850 mm.	1468 x 600 x 850 mm.	1960 x 600 x 850 mm.	2452 x 600 x 850 mm.	1468 x 600 x 850 mm.	1960 x 600 x 850 mm.	2452 x 600 x 850 mm.
Temperatura Temperature Température	<b>-2°C/+8°C</b>			<b>-18°C</b>			<b>+2°C/+6°C</b>		
Clase Climática Climatic class Classe climatique	4 / 38°C								
Tensión/Frecuencia Electrical data Tension électrique	230V/1ph/50Hz								
Controlador Controller Régulateur	Táctil Digital IP65								
Material Material [EXT/INT] Matériel	AISI 430 / Encimera-Worktop-Dessus AISI 304								
Espesor Thickness Épaisseur	70								
Aislamiento Isolation Isolation	40kg/m <sup>3</sup> / Free CFC's / Zero ODP-GWP								
Capacidad Capacity Capacité	255	400	540	255	400	540	255	400	540
Puertas Doors Portes	2	3	4	2	3	4	2	3	4
Nº estantes Nº shelves Nº d'étagères	2	3	4	2	3	4	2	3	4
Sistema de frío Cooling System Système de froid	MONOBLOCK Forzado / Forced air / Ventilé								
Desescarche Defrost Dégivrage	Parada compresor / Compressor off / Arrêt du compresseur			Gas caliente / Hot gas / Gaz chaud			Parada compresor / Compressor off / Arrêt du compresseur		
Expansión Expansion Expansion	Capilar / Capillary / Capillaire			Válvula de expansión termostática / Thermostatic expansion valve / Valve d'expansion thermostatique			Capilar / Capillary / Capillaire		
Potencia Power Puissance	255	410	605	694	723	264	269	429	
Potencia frig. Cooling capacity Puissance Frig.	370	690	445	540	370	690			
Consumo Consumption Consommation	2,04	2,37	2,40	4,02	6,57	6,78	-	-	-
Clase energética Energy class Classe Énerg.	<b>B</b>			<b>C</b>			<b>-</b>		
Refrigerante Refrigerant Gaz	<b>R-290</b>								
Opcional Optional Options	Parrilla / Wire shelf / Grille [502X07]						<b>39 €</b>		
	115V/1ph/60Hz 230V/1ph/60Hz			115V/1ph/60Hz 230V/1ph/60Hz			115V/1ph/60Hz 230V/1ph/60Hz		
	Kit 2 cajones / 2 Drawer Kit / Kit 2 tiroirs 1/2 x 200 [JCAJ17FM61/2]						-		

Serie / Series / Série **IM 600**

+Info: [www.infrico.com](http://www.infrico.com)

IM602PCR



Opcional Kit 2 cajones /  
Optional 2 Drawer Kit /  
Optional Kit 2 tiroirs  
1/2 x 200 (JCAJ17FM61/2)

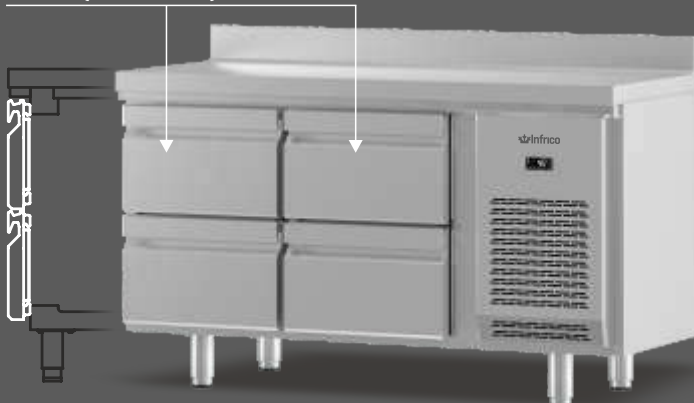

IM602P

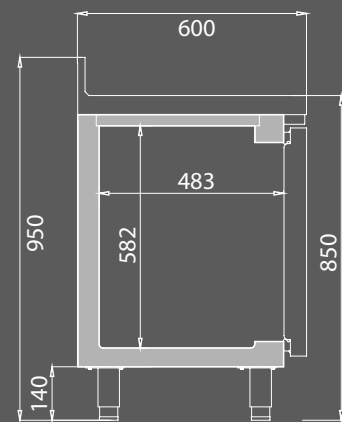

**Controlador digital IP 65.**  
Digital control IP65  
Contrôleur digital IP 65.









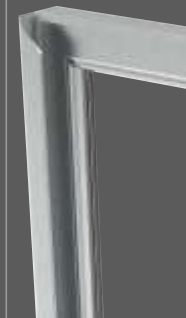

**Circulación optimizada del aire**  
Optimal air flow  
Circulation d'air optimisée

**Sistema de ventilación de condensación frontal**  
Front breathing condensation system  
Système de ventilation à condensation frontale

**Tirador p. cristal**  
Glass door handle  
Poignée p. vitrée



# Mesas refrigeración, congelación y puertas de cristal GN1/1 / GN1/1 Refrigerated counters, freezers and glass doors / Dessertes positives, négatives et portes vitrées GN1/1

MODELO MODELE MODÈLE									
Precio Price Prix									
Medidas Measures [mm] Mesures	1468 x 700 x 850 mm.	1960 x 700 x 850 mm.	2452 x 700 x 850 mm.	1468 x 700 x 850 mm.	1960 x 700 x 850 mm.	2452 x 700 x 850 mm.	1468 x 700 x 850 mm.	1960 x 700 x 850 mm.	2452 x 700 x 850 mm.
Temperatura Temperature Température [°C]	<b>-2°C/+8°C</b>			<b>-18°C</b>			<b>+2°C/+6°C</b>		
Clase Climática Climatic class Classe climatique [°C]	4 / 38°C								
Tensión/Frecuencia Electrical data Tension électrique	230V/1ph/50Hz								
Controlador Controller Régulateur	Digital IP65								
Material Material [EXT/INT] Matériel	AISI 430 / Encimera-Worktop-Dessus AISI 304								
Espesor Thickness Épaisseur [mm]	70								
Aislamiento Isolation Isolation [mm]	40kg/m <sup>3</sup> / Free CFC's / Zero ODP-GWP								
Capacidad Capacity Capacité [L]	305	465	630	305	465	630	305	465	630
Puertas Doors Portes	2	3	4	2	3	4	2	3	4
Nº estantes Nº shelves Nº d'étagères	2	3	4	2	3	4	2	3	4
Sistema de frío Cooling System Système de froid	MONOBLOCK Forzado / Forced air / Ventilé								
Desescarche Defrost Dégivrage	Parada compresor / Compressor off / Arrêt du compresseur			Gas caliente / Hot gas / Gaz chaud			Parada compresor / Compressor off / Arrêt du compresseur		
Expansión Expansion Expansion	Capilar / Capillary / Capillaire			Válvula de expansión termostática / Thermostatic expansion valve / Valve d'expansion thermostatique			Capilar / Capillary / Capillaire		
Potencia Power Puissance [W]	297	460		645	735	880	300	474	479
Potencia frig. Cooling capacity Puissance Frig. [W A -10°C]	370	690		445	540	640	370	690	
Consumo Consumption Consommation [kWh/ 24h]	1,97	2,26	2,61	5,54	7,79	9,03	-		
Clase energética Energy class Classe Énerg.	<b>B</b>			<b>C</b>	<b>D</b>		-		
Refrigerante Refrigerant Gaz	<b>R-290</b>								
Opcional Optional Options	Parrilla / Wire shelf / Grille 530x325 [502X12] Juego de guías / Slides / Jeu de Glissières [GUALO115550; GUALO215550]								
	115V/1ph/60Hz 230V/1ph/60Hz			115V/1ph/60Hz 230V/1ph/60Hz			115V/1ph/60Hz 230V/1ph/60Hz		
	Kit 2 cajones / 2 Drawer Kit / Kit 2 tiroirs 1/2 x 200 [JCAJ17FM71/2]						-		

Serie / Series / Série **IM 700**

+Info: [www.infrico.com](http://www.infrico.com)

IM703PN



**Ventilación frontal**  
Front breathing  
Ventilation frontale



**Controlador digital IP 65.**  
Digital control IP65  
Contrôleur digital IP 65.



**Circulación optimizada del aire**  
Optimal air flow  
Circulation d'air optimisée

**Sistema de ventilación de condensación frontal**  
Front breathing condensation system  
Système de ventilation à condensation frontale

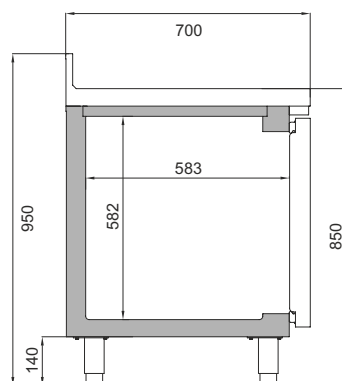

**Tirador p. cristal**  
Glass door handle  
Poignée p. vitrée



**Opcional** Kit 2 cajones /  
Optional 2 Drawer Kit /  
Optional Kit 2 tiroirs

**Costado inyectado**  
Insulated side  
Joue Isolée



IM702P

**Puertas con doble acristalamiento (6-15-5)**  
Double glazed doors [6-15-5]  
Portes double vitrage [6-15-5]



IM702PCR

# Frente mostrador / Tall back bar counter / Dessertes arrière bar positives

MODELO  
MODELE  
MODÈLE



IF602P



IF603P



IF604P



IF602PCR



IF603PCR



IF604PCR

Precio Price Prix							
<b>Medidas</b> Measures [mm] Mesures		1468 x 600 x 1050 mm.	1960 x 600 x 1050 mm.	2452 x 600 x 1050 mm.	1468 x 600 x 1050 mm.	1960 x 600 x 1050 mm.	2452 x 600 x 1050 mm.
<b>Temperatura</b> Temperature Température	[°C]	<b>-2°C/+8°C</b>			<b>+2°C/+6°C</b>		
<b>Clase Climática</b> Climatic class Classe climatique	[°C]	4 / 38°C					
<b>Tensión/Frecuencia</b> Electrical data Tension électrique		230V/1ph/50Hz					
<b>Controlador</b> Controller Régulateur		Digital IP65					
<b>Material</b> Material [EXT/INT] Matériel		AISI 430 / Encimera-Worktop-Dessus AISI 304					
<b>Espesor</b> Thickness Épaisseur	[mm]	70					
<b>Aislamiento</b> Isolation Isolation	[mm]	40kg/m <sup>3</sup> / Free CFC's / Zero ODP-GWP					
<b>Capacidad</b> Capacity Capacité	[L]	345	535	730	345	535	730
<b>Puertas</b> Doors Portes		2	3	4	2	3	4
<b>Nº estantes</b> Nº shelves Nº d'étagères		4	6	8	4	6	8
<b>Sistema de frío</b> Cooling System Système de froid		MONOBLOCK Forzado / Forced air / Ventilé					
<b>Desescarche</b> Defrost Dégivrage		Parada compresor / Compressor off / Arrêt du compresseur					
<b>Expansión</b> Expansion Expansion		Capilar / Capillary / Capillaire					
<b>Potencia</b> Power Puissance	[W]	264	435		273	450	455
<b>Potencia frig.</b> Cooling capacity Puissance Frig.	[W A -10°C]	370	690		370	690	690
<b>Consumo</b> Consumption Consommation	[kWh/ 24h]	2,04	2,40	2,73	-	-	-
<b>Clase energética</b> Energy class Classe Énerg.		<b>B</b>			-		
<b>Refrigerante</b> Refrigerant Gaz		<b>R-290</b>					
<b>Opcional</b> Optional Options		Parrilla / Wire shelf / Grille 325x430 [502X07] 115V/1ph/60Hz 230V/1ph/60Hz					
		Tolva / Coffee-grounds hopper / Tiroir marc à café ou 1 tiroir neutre					



Serie / Series / Série **IF 600**

+Info: [www.infrico.com](http://www.infrico.com)

IF603P



**Suplemento Parrilla incluido**  
**Supplement Wire Shelf including**  
 Supplément Grille inclus

**Puertas con doble acristalamiento [6-15-5]**  
**Double glazed doors [6-15-5]**  
 Portes double vitrage [6-15-5]



**Controlador digital IP 65.**  
 Digital control IP65  
 Contrôleur digital IP 65.



**Tolva opcional**  
 Optional coffee-grounds hopper  
 Tiroir marc à café ou 1 tiroir neutre



**Tirador p. cristal**  
 Glass door handle  
 Poignée p. vitrée

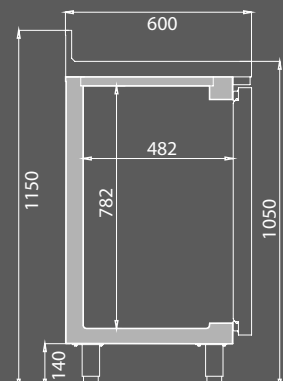







IF603PCR

**Mesas cafetera /  
Shelf unit /  
Meuble étagère  
(IEST)**

MESA CAFETERA / COFFE UNIT / MEUBLE CAFÉTÉRIA

**Mesas estantería /  
Coffee unit /  
Meuble cafétéria  
(IMC)**

MESA ESTANTERÍA / SHELF UNIT / MEUBLE ÉTAGÈRE

MODELO MODELE MODÈLE						
	IMC100	IMC150	IMC200	IEST100	IEST150	IEST200
Precio Price Prix						
Medidas Measures [mm] Mesures	1000 x 600 x 1050 mm.	1470 x 600 x 1050 mm.	1960 x 600 x 1050 mm.	1000 x 600 x 1050 mm.	1470 x 600 x 1050 mm.	1960 x 600 x 1050 mm.
Material Material Matériel	[EXT/INT] AISI 304					
Puertas Doors Portes	1	1	1	-	-	-
Cajones / Tolva Drawers / Hopper Portes	1/1	1/1	2/1	-	-	-
Estantes Shelves Étagères	1	1	1	1	1	1
Opcional Optional Options	Estante adicional / Additional shelf / Étagère extra (IMC100) <b>90 €</b> Estante adicional / Additional shelf / Étagère extra (IMC150) <b>107 €</b> Estante adicional / Additional shelf / Étagère extra (IMC200) <b>123 €</b>			Estante adicional / Additional shelf / Étagère extra (IEST100) <b>37 €</b> Estante adicional / Additional shelf / Étagère extra (IEST150) <b>54 €</b> Estante adicional / Additional shelf / Étagère extra (IEST200) <b>90 €</b>		



IMC150



IEST150



Serie / Series / Série **IMC / IEST**

+Info: [www.infrico.com](http://www.infrico.com)

IMC200



IMC100

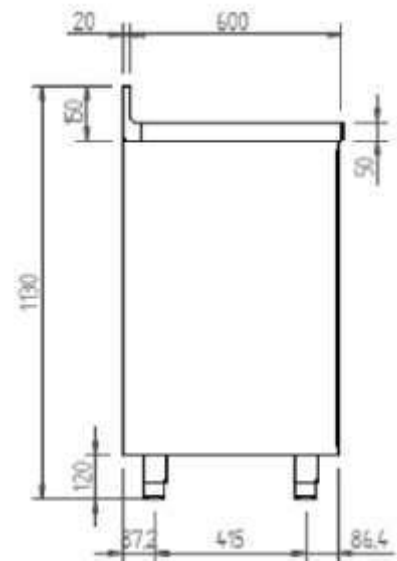

# Armario refrigeración, congelación y puertas de cristal / Reach in refrigerators, freezers and glass door / Armoires positives, négatives et portes vitrées



MODELO MODELE MODÈLE	IAN501	IAN502	IAN1002	IAN1004	IAN501N	IAN1002N	IAN501CR	IAN1002CR
<b>Precio</b> Price Prix								
<b>Medidas</b> Measures [mm] Mesures	687 x 712 x 2060 mm.	687 x 712 x 2060 mm.	1385 x 712 x 2060 mm.	1385 x 712 x 2060 mm.	687 x 712 x 2060 mm.	1385 x 712 x 2060 mm.	687 x 712 x 2060 mm.	1387 x 712 x 2060 mm.
<b>Temperatura</b> Temperature Température	-2°C/+8°C				-18°C		+2°C/+6°C	
<b>Clase Climática</b> Climatic class Classe climatique	4 / 38°C							
<b>Tensión/Frecuencia</b> Electrical data Tension électrique	230V/1ph/50Hz							
<b>Controlador</b> Controller Régulateur	Digital IP65							
<b>Material</b> Material [EXT/INT] Matériel	AISI 430							
<b>Espesor</b> Thickness Épaisseur	55							
<b>Aislamiento</b> Isolation Isolation	40kg/m <sup>3</sup> / Free CFC's / Zero ODP-GWP							
<b>Capacidad</b> Capacity Capacité	490		1070		490	1070	490	1070
<b>Puertas</b> Doors Portes	1	2	2	4	1	2	1	2
<b>Nº estantes</b> Nº shelves Nº d'étagères	3		6		3	6	3	6
<b>Sistema de frío</b> Cooling System Système de froid	Forzado / Forced air / Ventilé							
<b>Desescarche</b> Defrost Dégivrage	Parada compresor / Compressor off / Arrêt du compresseur				Gas caliente / Hot gas / Gaz chaud		Parada compresor / Compressor off / Arrêt du compresseur	
<b>Expansión</b> Expansion Expansion	Capilar / Capillary / Capillaire							
<b>Potencia</b> Power Puissance	265		435		625	905	285	475
<b>Potencia frig.</b> Cooling capacity [WA -10/-30°C] Puissance Frig.	370		690		540	720	370	690
<b>Consumo</b> Consumption [kWh/ 24h] Consommation	1,58		3,04		6,70	11,85	-	-
<b>Clase energética</b> Energy class Classe Énerg.	C				D		-	
<b>Refrigerante</b> Refrigerant Gaz	R-290							
<b>Opcional</b> Optional Options	Parrilla / Wire shelf / Grille [502X14] Ruedas / Casters / Roulettes [705X16=2; 705X17=2] 115V/1ph/60Hz 230V/1ph/60Hz							

Serie / Series / Série **IAN 500/1000**

+Info: [www.infrico.com](http://www.infrico.com)

IAN1002 CR

**Puerta con doble acristalamiento [6-15-5]**  
 Double glazed door [6-15-5]  
 Portes double vitrage [6-15-5]

**3 parrillas por puerta**  
 3 shelves per door  
 3 grilles par porte

**Tirador p. cristal**  
 Glass door handle  
 Poignée p. vitrée



IAN501



IAN1002N

**Controlador digital IP 65.**  
 Digital control IP65  
 Contrôleur digital IP 65.

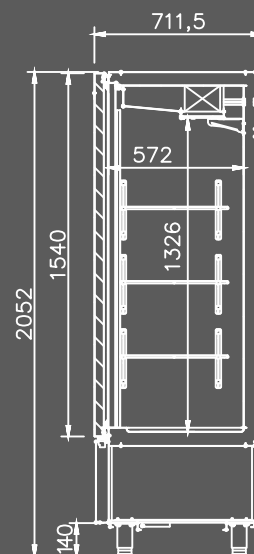

# Armario refrigeración, congelación y puertas de cristal / Reach in refrigerators, freezers and glass door / Armoires positives, négatives et portes vitrées

REFRIG / REFRIG / POSIT

CONGEL / FREEZ / NÉGAT

REFRIG / REFRIG / POSIT



MODELO  
MODELE  
MODÈLE

IAG701

IAG1402

IAG701N

IAG1402N

IAG701CR

IAG1402CR

Precio Price Prix						
Medidas Measures [mm] Mesures	687 x 838 x 2060 mm.	1387 x 838 x 2060 mm.	687 x 838 x 2060 mm.	1387 x 838 x 2060 mm.	687 x 838 x 2060 mm.	1387 x 838 x 2060 mm.
Temperatura Temperature Température	<b>-2°C/+8°C</b>		<b>-18°C</b>		<b>+2°C/+6°C</b>	
Clase Climática Climatic class Classe climatique	4 / 38°C					
Tensión/Frecuencia Electrical data Tension électrique	230V/1ph/50Hz					
Controlador Controller Régulateur	Digital IP65					
Material Material [EXT/INT] Matériel	AISI 430					
Espesor Thickness Épaisseur	55					
Aislamiento Isolation Isolation	40kg/m <sup>3</sup> / Free CFC's / Zero ODP-GWP					
Capacidad Capacity Capacité	580	1280	580	1280	580	1280
Puertas Doors Portes	1	2	1	2	1	2
Nº estantes Nº shelves Nº d'étagères	3	6	3	6	3	6
Sistema de frío Cooling System Système de froid	Forzado / Forced air / Ventilé					
Desescarche Defrost Dégivrage	Parada compresor / Compressor off / Arrêt du compresseur		Gas caliente / Hot gas / Gaz chaud		Parada compresor / Compressor off / Arrêt du compresseur	
Expansión Expansion Expansion	Capilar / Capillary / Capillaire		Válvula de expansión termostática / Thermostatic expansion valve / Valve d'expansion thermostatique		Capilar / Capillary / Capillaire	
Potencia Power Puissance	265	445	625	905	285	495
Potencia frig. Cooling capacity Puissance Frig.	370	690	540	720	370	690
Consumo Consumption Consommation	2,5	3,3	8,45	15,21	-	
Clase energética Energy class Classe Énerg.	<b>D</b>	<b>C</b>	<b>C</b>	<b>D</b>	-	
Refrigerante Refrigerant Gaz	<b>R-290</b>					
Opcional Optional Options	Parrilla / Wire shelf / Grille [530X650mm] [502X14] Juego de guías GD / Slides GD / Jeu de Glisières GD [GUIAL0115641; GUIAL0215641] Ruedas / Casters / Roulettes [705X16=2; 705X17=2] Juego de guías / Slides / Jeu de Glisières GN 2/1 650x450 [GUIA01UAGB/GUIA02UAGB] Juego de guías / Slides / Jeu de Glisières 600x400 [GUIAL01641P/GUIAL02641P] 115V/1ph/60Hz 230V/1ph/60Hz					

Serie / Series / Série **IAG 700/1400**

+Info: [www.infrico.com](http://www.infrico.com)

IAG701

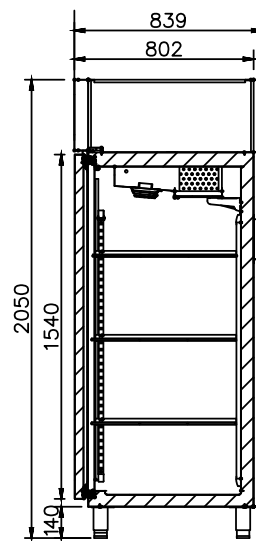

Controlador digital IP 65.  
Digital control IP65  
Contrôleur digital IP 65.



IAG1402CR

**Puerta con doble acristalamiento [6-15-5]**  
Double glazed door [6-15-5]  
Portes double vitrage [6-15-5]

OPCIONAL  
OPTIONAL  
OPTIONAL



Tirador p. cristal  
Glass door handle  
Poignée p. vitrée





+Info: [www.infrico.com](http://www.infrico.com)



# Línea Americana

American Line / Ligne Américaine







Serie / Series / Série  
**GN 2/1**



AN  
AN BT  
AN MX  
AN CR \_\_\_\_\_ 182-183

Serie / Series / Série  
**UC**



UC R/RCR/P  
UC F  
UC RW/RWCR/FW \_\_\_\_\_ 184-191

Serie / Series / Série  
**UC PMT**



UC P / PD  
UC PMT \_\_\_\_\_ 192-195

Serie / Series / Série  
**MR**



MR  
MR BT \_\_\_\_\_ 196-197

Serie / Series / Série  
**MR / MR EN**



MR  
MR BT  
MR EN \_\_\_\_\_ 198-199

Serie / Series / Série  
**MR GT / MPG COMBO**



MR GT COMBO  
MPG COMBO \_\_\_\_\_ 200-201

Serie / Series / Série  
**CHEF BASES**



MSG \_\_\_\_\_ 202-203

Serie / Series / Série  
**BACK BAR**



ERV II SD  
ERV II GD \_\_\_\_\_ 204-205



# 6. Línea Americana

## American Line / Ligne Americaine



**SOPORTA HASTA**  
HOLDS UP TO  
SUPPORTE JUSQU'À

**450Kg**

MSG 72, 96, 110



**SOPORTA HASTA**  
HOLDS UP TO  
SUPPORTE JUSQU'À

**300Kg**

MSG 36, 48, 52

Doble acristalamiento templado, bajo emisoro con carga de Argón (4-27-4).

Double tempered glass, low-e with argon charge (4-27-4).

Triple vitrage et verre trempé (4-12-3-12-4).

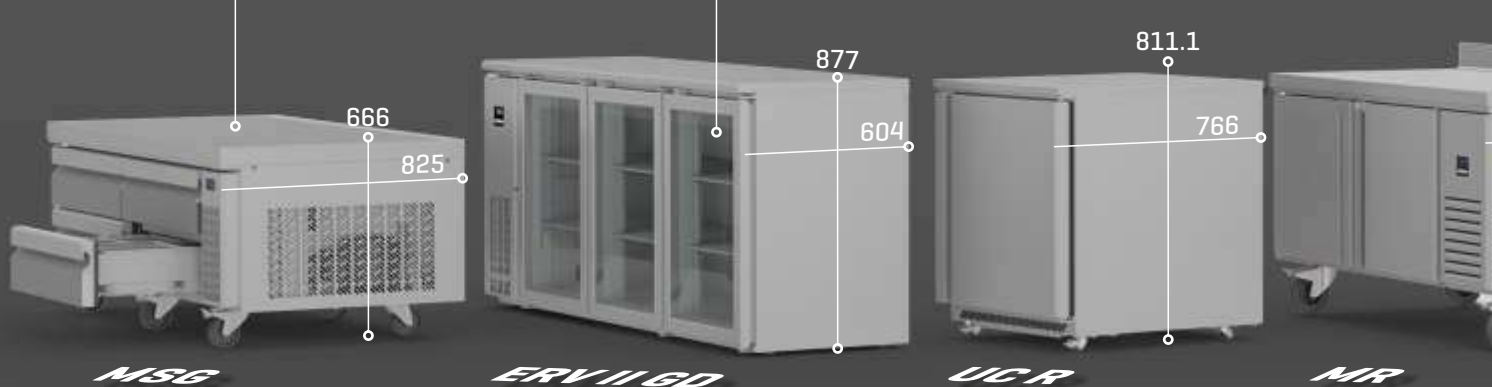
### Iluminación / Lighting / Éclairage

Incorporación de iluminación LED, llegando a reducir el consumo energético entre un 80% y 90%, respecto a una bombilla tradicional. RGB opcional.

LED lighting incorporated, reducing energetic consumption between 80% and 90% respect to a traditional light bulb. RGB optional.

Éclairage LED, réduisant la consommation énergétique entre 80% et 90%, par rapport à une ampoule traditionnelle. RGB optionnel.



+Info: [www.infrico.com](http://www.infrico.com)

Tiradores ergonómicos.

Ergonomic handles.

Poignées ergonomiques.



Ruedas incluidas  
[excepto en ERV] /

Casters included  
[except ERV] /

Roues incluses  
[sauf ERV]



# Armarios de refrigeración GN2/1 / GN2/1 Reach in refrigerator / Armoire positive GN2/1

REFRIG / REFRIG / POSIT

CONGEL / FREEZ / NÉGAT

MIXTO  
DUAL TEMP.  
MIXTE

REFRIG / REFRIG / POSIT



MODELO  
MODELE  
MODÈLE

AN 23

AN 49

AN 67

AN 23 BT

AN 49 BT

AN 67 BT

AN 49 MX

AN 23 CR

AN 49 CR

AN 67 CR

Precio Price Prix										
Medidas Measures Mesures [mm]	687 x 796 x 2112 mm.	1384 x 796 x 2112 mm.	2081 x 796 x 2112 mm.	687 x 796 x 2112 mm.	1384 x 796 x 2112 mm.	2081 x 796 x 2112 mm.	1384 x 796 x 2112 mm.	687 x 796 x 2112 mm.	1384 x 796 x 2112 mm.	2081 x 796 x 2112 mm.
Temperatura Temperature Température [°C]	-2°C/+8°C			-18°C			-2°C/+8°C -18°C	+2°C / +6°C		
Clase Climática Climatic class Classe climatique [°C]	5 / 40° C						4 / 38° C			
Tensión/Frecuencia Electrical data Tension électrique	230V/1ph/50Hz									
Controlador Controller Régulateur	Digital									
Material Material [EXT/INT] Matériel	Ext/Int: AISI 430									
Espesor Thickness Épaisseur [mm]	55									
Aislamiento Isolation Isolation [mm]	40kg/m³ / Free CFC's / Zero ODP-GWP									
Capacidad Capacity Capacité [L]	610	1350	1886	610	1350	1886	610+610	610	1350	1886
Puertas Doors Portes	1	2	3	1	2	3	2	1	2	3
Nº parrillas / Guías Nº shelves / Slides Nº de grilles / Glissière	3/3 [650x530]	6/6 [650x530]	9/9 [650x530]	3/3 [650x530]	6/6 [650x530]	9/9 [650x530]	6/6 [650x530]	4/4 [650x530]	8/8 [650x530]	12/12 [650x530]
Desescarche Defrost Dégivrage	Parada de compresor / Compresor off / Arrêt du compresseur			Gas caliente / Hot gas / Gaz chaud			Parada compresor / Gas cal. Compresor off / Hot gas Arrêt compresor / Gaz chaud	Parada de compresor / Compresor off / Arrêt du compresseur		
Expansión Expansion Expansion	Capilar / Capillary / Capillaire			Válvula termostática / Expansion valve / Détendeur thermostatique			Capilar (+) V. Exp (-) Cap (+) Exp. valve (-) Cap (+) V. d'exp (-)	Capilar / Capillary / Capillaire		
Potencia Power Puissance [W]	267	455	460	662	640	1362	1330	460	495	650
Potencia frig. Cooling capacity Puissance Frig. [W A] [-10°/30°C BT]	343	690	690	639	742	1278	690/640	690	690	934
Consumo Consumption Consommation [kWh/24h]	1,50	1,93	3,40	6,86	10,16	16,08				
Clase energética Energy class Classe Énerg.	<b>B</b>	<b>A</b>	<b>B</b>	<b>C</b>	<b>D</b>	<b>C</b>				
Refrigerante Refrigerant Gaz	<b>R-290</b>									
Opcional Optional Options	115V/1 ph/60 Hz 230V/1 ph/60 Hz			115V/1 ph/60 Hz 230V/1 ph/60 Hz			115V/1 ph/60 Hz 230V/1 ph/60 Hz			
	Juego de guías / Slides / Jeu de Glissières [GUIAAN60] Patas / Legs / Pieds [506X42]									
	Parrilla / Wire shelf / Grille [502X14]							Parrilla reforzada / Reinforced wire shelf Grille renforcée [502x91] Led RGB [por puerta] / Led RGB [per door] LED RGB [par porte]		

Serie / Series / Série **GN 2/1**

+Info: [www.infrico.com](http://www.infrico.com)

AN 67 CR



Doble acristalamiento 6-15-5  
Double glass 6-15-5  
Double vitrage 6-15-5



AN 49 BT



**Cerradura incorporada**  
Included lock  
Serrure de série



**Rejilla inferior**  
Bottom grill side  
Grille inférieure

**Ruedas con freno delantero**  
Wheels with front brake  
Roues avec frein avant

**Led RGB Opcional**  
Led RGB Optional  
Led RGB Options



**Parrilla reforzada**  
Reinforced wire shelf  
Grille renforcée

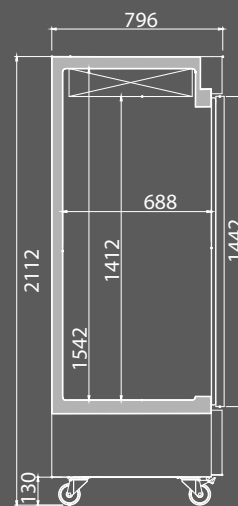
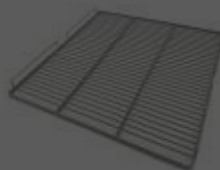

# Mesas undercounter de refrigeración / Undercounter refrigerators / Table undercounter positive

REFRIG / REFRIG / POSIT

REFRIG / REFRIG / POSIT



MODELO MODELE MODÈLE	UC 27 R UC 27 R CR	UC 36 R UC 36 R CR	UC 48 R UC 48 R CR	UC 60 R UC 60 R CR	UC 72 R UC 72 R CR	UC 27 2D	UC 48 4D	UC 60 4D
<b>Precio</b> Price Prix	<b>R</b>							
<b>Medidas</b> Measures Mesures	<b>R CR</b>							
	702 x 766 x 811.1 mm.	920 x 766 x 811.1 mm.	1227 x 766 x 811.1 mm.	1533 x 766 x 811.1 mm.	1844 x 766 x 811.1 mm.	702 x 766 x 811.1 mm.	1227 x 766 x 811.1 mm.	1533 x 766 x 811.1 mm.
<b>Temperatura</b> Temperature Temperature	-2°C/+8°C							
<b>Clase Climática</b> Climatic class Classe climatique	4 / 38° C							
<b>Tensión/Frecuencia</b> Electrical data Tension électrique	230V/1ph/50Hz							
<b>Material</b> Material Matériel	Ext/Int - Ext/Int - Ext/Int: AISI 430 Encimera / Worktop / Plan du travail: AISI 304							
<b>Espesor</b> Thickness Épaisseur	55							
<b>Capacidad</b> Capacity Capacité	200	270	380	480	590	200	380	480
<b>Puertas/Cajones</b> Doors/Drawers Tiroirs	1	2		3		2	4	
<b>Nº parrillas J. guías</b> N° shelves / Slides N° de grilles / Glissière	2/2 [570x437]	4/4 [380x437]	4/4 [540x437]	4/4 [693x437]	6/6 [570x437] [540x437]	-	-	-
<b>Desescarche</b> Defrost Dégivrache	-							
<b>Potencia</b> Power Puissance	205				364		205	
<b>Potencia frig.</b> Cooling capacity Puissance Frig.	370				690		370	
<b>Consumo</b> Consumption Consommation	1,21	1,50	1,70	1,83	2,25	1,21	1,70	1,83
<b>Clase energética</b> Energy class Classe Énerg.	<b>A</b>					<b>A</b>		
<b>Refrigerante</b> Refrigerant Gaz	<b>R-290</b>							
<b>Opcional</b> Optional Options	Parrilla / Wire shelf / Grille UC27 [502X73] Parrilla / Wire shelf / Grille UC48 [502X74] Parrilla / Wire shelf / Grille UC60 [502X75] Cerradura / Lock / Serrure [506X120; 506X121]					-		
	Patas / Legs / Pieds [506X42] 115V/1ph/60Hz 230V/1ph/60Hz							



Serie / Series / Série **UC R/RCR/D**

+Info: [www.infrico.com](http://www.infrico.com)

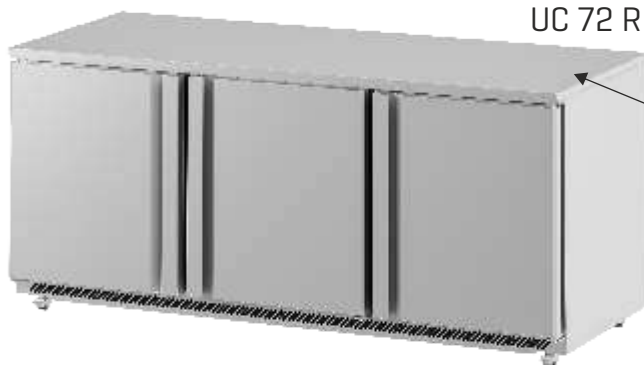

UC 72 R

**Encimera acero inox AISI 304**  
AISI 304 stainless steel worktop  
Plan de travail en AISI 304

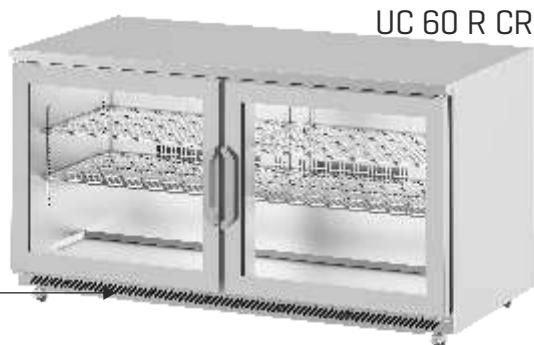

UC 60 R CR

**Sistema de ventilación frontal**  
Front breathing refrigeration system  
Système de ventilation frontale

UC 60 4D



**Cajones con guías telescópicas con salida mayorada y sistema de autocierre.**  
Drawers with telescopic guides for complete opening and self closing system.  
Tiroirs avec glissières télescopiques avec ouverture facile et système de fermeture automatique.

UC 27 2D



**Cajones no incluidos / Drawers not included / Tiroirs non inclus**

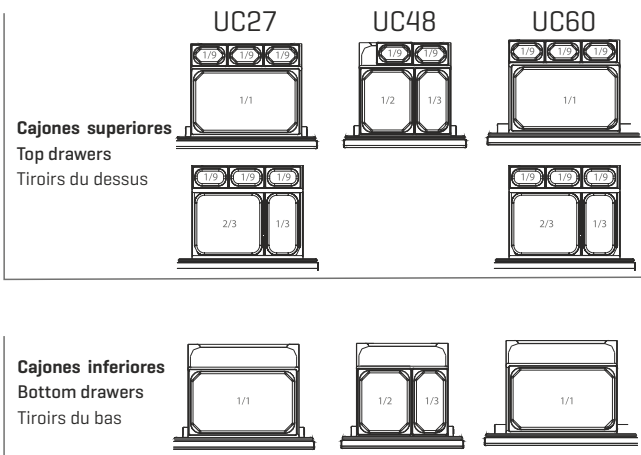

**Cada cajón UC incluye una barra divisoria para las distintas configuraciones de bandejas. Hay otras barras disponibles en caso de cambio de la distribución.**



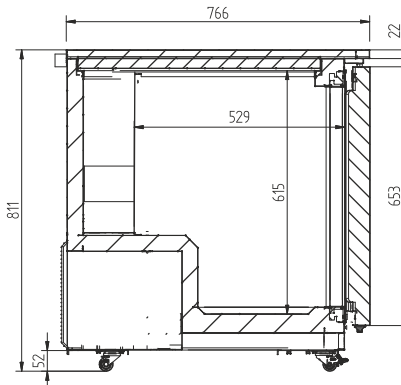

Each UC drawer includes one divider bar for different pan configurations. Other divider bars are available for varying size pan distribution.

Chaque tiroir UC comprend une barre de séparation pour différentes configurations de bacs. D'autres barres de séparation sont disponibles pour la répartition de bacs de taille variable.



# Mesas undercounter de congelación / Undercounter freezers / Table undercounter négative

CONGEL / FREEZ / NÉGAT

MODELO MODELE MODÈLE				
	UC27F	UC36F	UC48F	UC60F
<b>Precio</b> Price Prix				
<b>Medidas</b> Measures Mesures (mm)	702 x 766 x 811.1 mm.	920 x 766 x 811.1 mm.	1227 x 766 x 811.1 mm.	1533 x 766 x 811.1 mm.
<b>Temperatura</b> Temperature Temperature (°C)	<b>-18°C</b>			
<b>Clase Climática</b> Climatic class Classe climatique (°C)	4 / 38° C			
<b>Tensión/Frecuencia</b> Electrical data Tension électrique	230V/1ph/50Hz			
<b>Material</b> Material Matériel (EXT/INT)	Ext/Int - Ext/Int - Ext/Int: AISI 430 Encimera / Worktop / Plan du travail: AISI 304			
<b>Espesor</b> Thickness Épaisseur (mm)	55			
<b>Capacidad</b> Capacity Capacité (L)	200	270	380	480
<b>Puertas/Cajones</b> Doors/Drawers Tiroirs	1	2		
<b>Nº parrillas J. guías</b> N° shelves / Slides N° de grilles / Glissière	2/2 [570x437]	4/4 [380x437]	4/4 [540x437]	6/6 [693x437]
<b>Desescarche</b> Defrost Dégivrache	-			
<b>Potencia</b> Power Puissance (W)	408	457	507	637
<b>Potencia frig.</b> Cooling capacity Puissance Frig. (W A) (-10° / -30° C @T)	300			
<b>Consumo</b> Consumption Consommation (kWh/ 24h)	2,54	2,90	3,27	4,11
<b>Clase energética</b> Energy class Classe Énerg.	<b>A</b>			
<b>Refrigerante</b> Refrigerant Gaz	<b>R-290</b>			
<b>Opcional</b> Optional Options	Parrilla / Wire shelf / Grille UC27 [502X73] Parrilla / Wire shelf / Grille UC48 [502X74] Parrilla / Wire shelf / Grille UC60 [502X75] Cerradura / Lock / Serrure [506X120; 506X121] Patas / Legs / Pieds [506X42] 115V/1ph/60Hz 230V/1ph/60Hz			

Serie / Series / Série **UC F**

+Info: [www.infrico.com](http://www.infrico.com)

UC 27 F

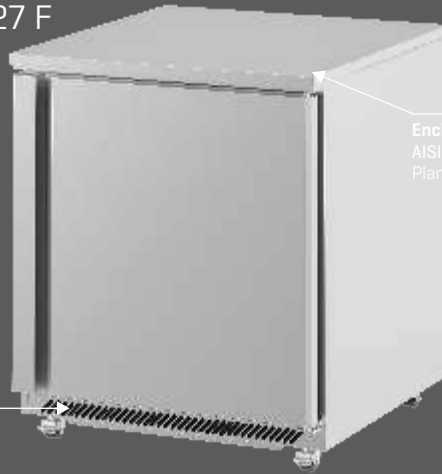

Encimera acero inox AISI 304  
AISI 304 stainless steel worktop  
Plan de travail en AISI 304

Sistema de ventilación frontal  
Front breathing refrigeration system  
Système de ventilation frontale

UC 48 F

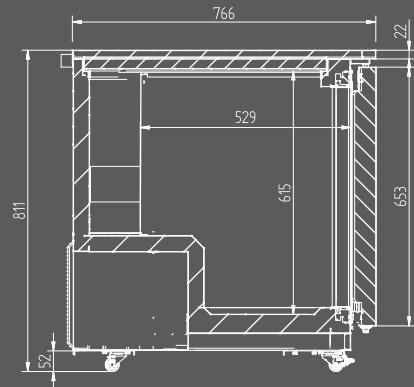

UC 60 F

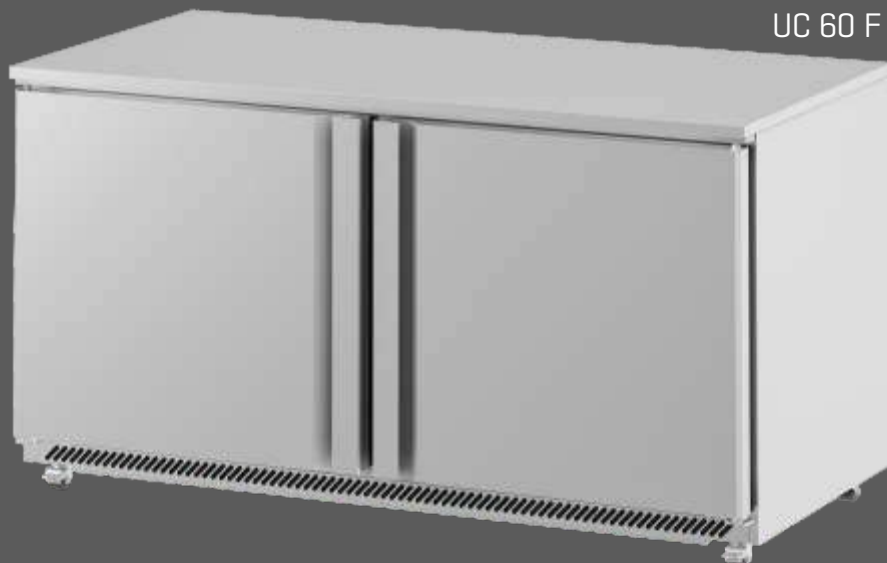

# Mesas Depth Worktop de refrigeración / Shallow Depth Worktop refrigerators / Table Depth Worktop positive

REFRIG / REFRIG / POSIT



UC 27 RW  
UC 27 RW CR



UC 36 RW  
UC 36 RW CR



UC 48 RW  
UC 48 RW CR



UC 60 RW  
UC 60 RW CR



UC 72 RW  
UC 72 RW CR

MODELO MODELE MODÈLE		UC 27 RW UC 27 RW CR	UC 36 RW UC 36 RW CR	UC 48 RW UC 48 RW CR	UC 60 RW UC 60 RW CR	UC 72 RW UC 72 RW CR
<b>Precio</b> Price Prix	<b>RW</b> <b>RW CR</b>					
<b>Medidas</b> Measures Mesures	(mm)	702 x 766 x 1007 mm.	920 x 766 x 1007 mm.	1227 x 766 x 1007 mm.	1533 x 766 x 1007 mm.	1844 x 766 x 1007 mm.
<b>Temperatura</b> Temperature Temperature	(°C)	<b>-2°C/+8°C</b>				
<b>Clase Climática</b> Climatic class Classe climatique	(°C)	4 / 38° C				
<b>Tensión/Frecuencia</b> Electrical data Tension électrique		230V/1ph/50Hz				
<b>Material</b> Material Matériel	(EXT/INT)	Ext/Int - Ext/Int - Ext/Int: AISI 430 Encimera / Worktop / Plan du travail: AISI 304				
<b>Espesor</b> Thickness Épaisseur	(mm)	55				
<b>Capacidad</b> Capacity Capacité	(L)	200	270	380	480	590
<b>Puertas/Cajones</b> Doors/Drawers Tiroirs		1	2		3	
<b>Nº parrillas J. guías</b> N° shelves / Slides N° de grilles / Glissière		2/2 [570x437]	4/4 [380x437]	4/4 [540x437]	4/4 [693x437]	6/6 [570x437] [540x437]
<b>Desescarche</b> Defrost Dégivrache		-				
<b>Potencia</b> Power Puissance	(W)	205				364
<b>Potencia frig.</b> Cooling capacity Puissance Frig.	(W A) [107 30°C @1]	370				690
<b>Consumo</b> Consumption Consommation	(kWh/ 24h)	1,21	1,50	1,70	1,83	2,25
<b>Clase energética</b> Energy class Classe Énerg.		<b>A</b>				
<b>Refrigerante</b> Refrigerant Gaz		<b>R-290</b>				
<b>Opcional</b> Optional Options		Parrilla / Wire shelf / Grille UC27 [502X73] Parrilla / Wire shelf / Grille UC48 [502X74] Parrilla / Wire shelf / Grille UC60 [502X75] Cerradura / Lock / Serrure [506X120; 506X121] Patas / Legs / Pieds [506X42] 115V/1ph/60Hz 230V/1ph/60Hz				

Serie / Series / Série **UC RW/RWCR**

+Info: [www.infrico.com](http://www.infrico.com)

UC 48 RW CR

Encimera acero inox AISI 304  
AISI 304 stainless steel worktop  
Plan de travail en AISI 304



UC 27 RW

Sistema de ventilación frontal  
Front breathing refrigeration system  
Système de ventilation frontale

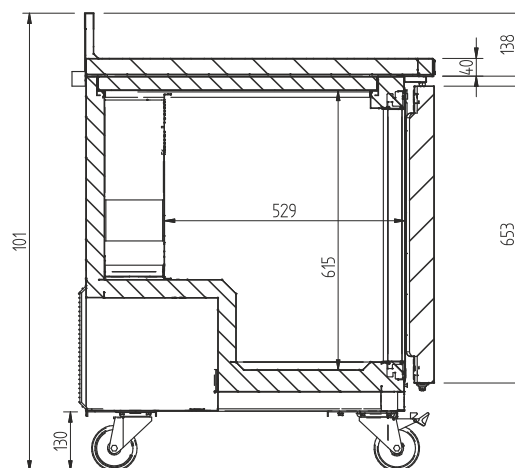





UC 72 RW CR



# Mesas Depth Worktop de congelación / Shallow Depth Worktop freezers / Table Depth Worktop négative

CONGEL / FREEZ / NÉGAT

MODELO MODELE MODÈLE	 UC 27 FW	 UC 36 FW	 UC 48 FW	 UC 60 FW
<b>Precio</b> Price Prix				
<b>Medidas</b> Measures Mesures (mm)	702 x 766 x 1007 mm.	920 x 766 x 1007 mm.	1227 x 766 x 1007 mm.	1533 x 766 x 1007 mm.
<b>Temperatura</b> Temperature Temperature (°C)	<b>-18°C</b>			
<b>Clase Climática</b> Climatic class Classe climatique (°C)	4 / 38° C			
<b>Tensión/Frecuencia</b> Electrical data Tension électrique	230V/1ph/50Hz			
<b>Material</b> Material Matériel (EXT/INT)	Ext/Int - Ext/Int - Ext/Int: AISI 430 Encimera / Worktop / Plan du travail: AISI 304			
<b>Espesor</b> Thickness Épaisseur (mm)	55			
<b>Capacidad</b> Capacity Capacité (L)	200	270	380	480
<b>Puertas/Cajones</b> Doors/Drawers Tiroirs	1	2		3
<b>Nº parrillas J. guías</b> N° shelves / Slides N° de grilles / Glissière	2/2 [570x437]	4/4 [380x437]	4/4 [540x437]	6/6 [693x437]
<b>Desescarche</b> Defrost Dégivrache	-			
<b>Potencia</b> Power Puissance (W)	408	457	507	637
<b>Potencia frig.</b> Cooling capacity Puissance Frig. (W A) (-10° / -30° C BT)	370			
<b>Consumo</b> Consumption Consommation (kWh/ 24h)	2,54	2,90	3,27	4,11
<b>Clase energética</b> Energy class Classe Énerg.	<b>A</b>			
<b>Refrigerante</b> Refrigerant Gaz	<b>R-290</b>			
<b>Opcional</b> Optional Options	Parrilla / Wire shelf / Grille UC27 [502X73] Parrilla / Wire shelf / Grille UC48 [502X74] Parrilla / Wire shelf / Grille UC60 [502X75] Cerradura / Lock / Serrure [506X120; 506X121] Patas / Legs / Pieds [506X42] 115V/1ph/60Hz 230V/1ph/60Hz			

Serie / Series / Série **UC FW**

+Info: [www.infrico.com](http://www.infrico.com)

UC 48 FW

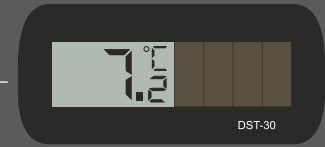

**Sistema de ventilación frontal**  
Front breathing refrigeration system  
Système de ventilation frontale

UC 27 FW

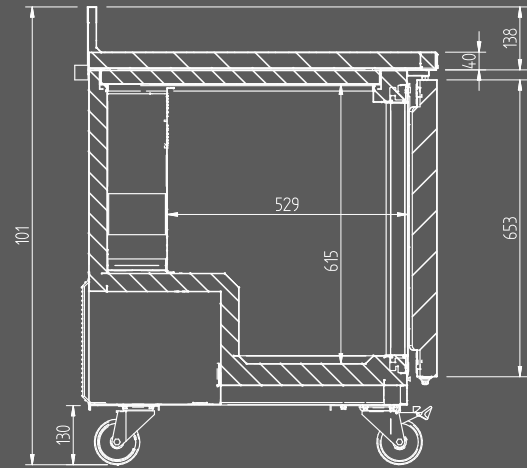

UC 60 FW



**Encimera acero inox AISI 304**  
AISI 304 stainless steel worktop  
Plan de travail en AISI 304

# Mesas undercounter de refrigeración para ensaladas

## Salads prep tables undercounters /

### Table undercounter positive préparation salade

REFRIGERACIÓN / REFRIGERATOR / POSITIVE



MODELO MODELE MODÈLE	UC 27 P	UC 36 P	UC 48 P	UC 60 P	UC 72 P	UC 27 P 2D	UC 48 P 4D	UC 60 P 4D
<b>Precio</b> Price Prix								
<b>Medidas</b> Measures Mesures [mm]	702 x 766 x 1175 mm.	920 x 766 x 1175 mm.	1227 x 766 x 1175 mm.	1533 x 766 x 1175 mm.	1844 x 766 x 1175 mm.	702 x 766 x 1175 mm.	1227 x 766 x 1175 mm.	1533 x 766 x 1175 mm.
<b>Temperatura</b> Temperature Temperature [°C]	0°C/+6°C							
<b>Clase Climática</b> Climatic class Classe climatique [°C]	4 / 38° C							
<b>Tensión/Frecuencia</b> Electrical data Tension électrique	230V/1ph/50Hz							
<b>Material</b> Material [EXT/INT] Matériel	Ext/Int - Ext/Int - Ext/Int: AISI 430 Respaldo / Back / Arrière: Acero galvanizado / Galvanized steel / Acier galvanisée Encimera / Worktop / Plan du travail: AISI 304							
<b>Espesor</b> Thickness Épaisseur [mm]	55							
<b>Capacidad</b> Capacity Capacité [L]	200	270	380	480	590	200	380	480
<b>Puertas</b> Doors Portes	1	2		3		4		
<b>Nº parrillas J. guías</b> N° shelves / Slides N° de grilles / Glissière	2/2 [570x437]	4/4 [380x437]	4/4 [540x437]	4/4 [693x437]	6/6 [570x437] [540x437]	-		
<b>Nº Bandejas</b> N° Pans N° Containers	8	8	12	16	18	6	12	16
<b>Evaporación</b> Evaporation Evaporation	Ventilado / Ventilated / Ventilé							
<b>Desescarche</b> Defrost Dégivrache	-							
<b>Potencia</b> Power Puissance [W]	205		364			205		
<b>Potencia frig.</b> Cooling capacity Puissance Frig. [W A -10°C]	370		690			370		
<b>Refrigerante</b> Refrigerant Gaz	R-290							
<b>Opcional</b> Optional Options	Tapa plana / Flat lid / Couvercle plat UC 27 P [TAPUC27PF] Tapa plana / Flat lid / Couvercle plat UC 48 P [TAPUC48PF] Tapa plana / Flat lid / Couvercle plat UC 60 P [TAPUC60PF] Tapa plana / Flat lid / Couvercle plat UC 72 P [TAPUC72PF] Patas / Legs / Pieds [506X42] 115V/1ph/60Hz 230V/1ph/60Hz							



Serie / Series / Série **UC P**

+Info: [www.infrico.com](http://www.infrico.com)



UC 72 P

Espacio para estante  
Shelf space  
Espaces pour étagères



UC 48 P

Combinación de bandejas / Incluidas  
Pans combinations / Included  
Combinaison de bacs / Inclus

UC 27 P

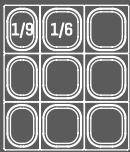

UC 48 P

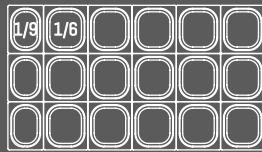

UC 60 P

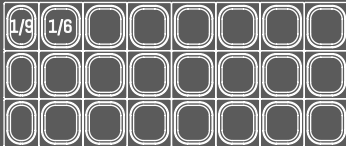

UC 72 P

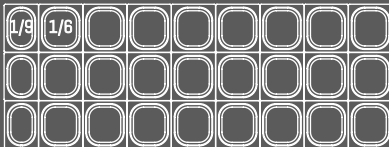

Tapa inyectada  
Insulated top lid  
Couvercle isolé



UC 60 P 4D

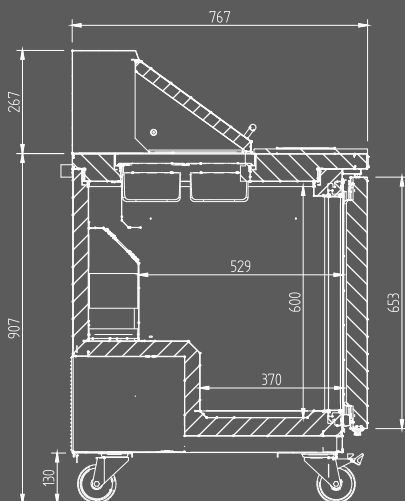

UC 27 P 2D



Tabla de corte  
Cutting board  
Table à découper



# Mesas undercounter de refrigeración para ensaladas-sandwiches megatop / Salads-sandwiches megatop undercounter / Table undercounter positive préparation salades-sandwiches megatop

REFRIGERACIÓN / REFRIGERATOR / POSITIVE

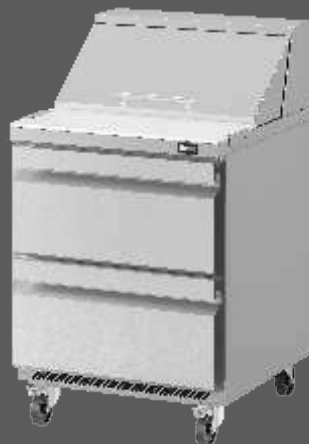
MODELO  
MODELE  
MODÈLE



UC 27 PMT



UC 36 PMT



UC 48 PMT



UC 60 PMT



UC 72 PMT

MODELO MODELE MODÈLE	UC 27 PMT	UC 36 PMT	UC 48 PMT	UC 60 PMT	UC 72 PMT
<b>Precio</b> Price Prix					
<b>Medidas</b> Measures Mesures (mm)	702 x 866 x 1246 mm.	920 x 866 x 1246 mm.	1227 x 866 x 1246 mm.	1533 x 866 x 1246 mm.	1844 x 866 x 1246 mm.
<b>Temperatura</b> Temperature Temperature (°C)	0°C/+6°C				
<b>Clase Climática</b> Climatic class Classe climatique (°C)	4 / 38° C				
<b>Tensión/Frecuencia</b> Electrical data Tension électrique	230V/1ph/50Hz				
<b>Material</b> Material Matériel (EXT/INT)	Ext/Int - Ext/Int - Ext/Int: AISI 430 Encimera / Worktop / Plan du travail: AISI 304				
<b>Espesor</b> Thickness Épaisseur (mm)	55				
<b>Capacidad</b> Capacity Capacité (L)	200	270	380	480	590
<b>Puertas</b> Doors Portes	1	2		3	
<b>Nº parrillas J. guías</b> N° shelves / Slides N° de grilles / Glissière	2 [570x437]	4 [380x437]	4 [540x437]	4 [693x437]	6 [540x437] [570x437]
<b>Nº Bandejas</b> N° Pans N° Containers	12	12	18	24	27
<b>Evaporación</b> Evaporation Evaporation	Ventilado / Ventilated / Ventilé				
<b>Desescarche</b> Defrost Dégivrache	-				
<b>Potencia</b> Power Puissance (W)	205			364	
<b>Potencia frig.</b> Cooling capacity Puissance Frig. (W A -10°C)	370			690	
<b>Refrigerante</b> Refrigerant Gaz	R-290				
<b>Opcional</b> Optional Options	Tapa plana / Flat lid / Couvercle plat UC 27 PMT [TAPUC27PMTF] Tapa plana / Flat lid / Couvercle plat UC 48 PMT [TAPUC48PMTF] Tapa plana / Flat lid / Couvercle plat UC 60 PMT [TAPUC60PMTF] Tapa plana / Flat lid / Couvercle plat UC 72 PMT [TAPUC72PMTF]  Patas / Legs / Pieds [506X42] 115V/1ph/60Hz 230V/1ph/60Hz				

Serie / Series / Série **UC PMT**

+Info: [www.infrico.com](http://www.infrico.com)

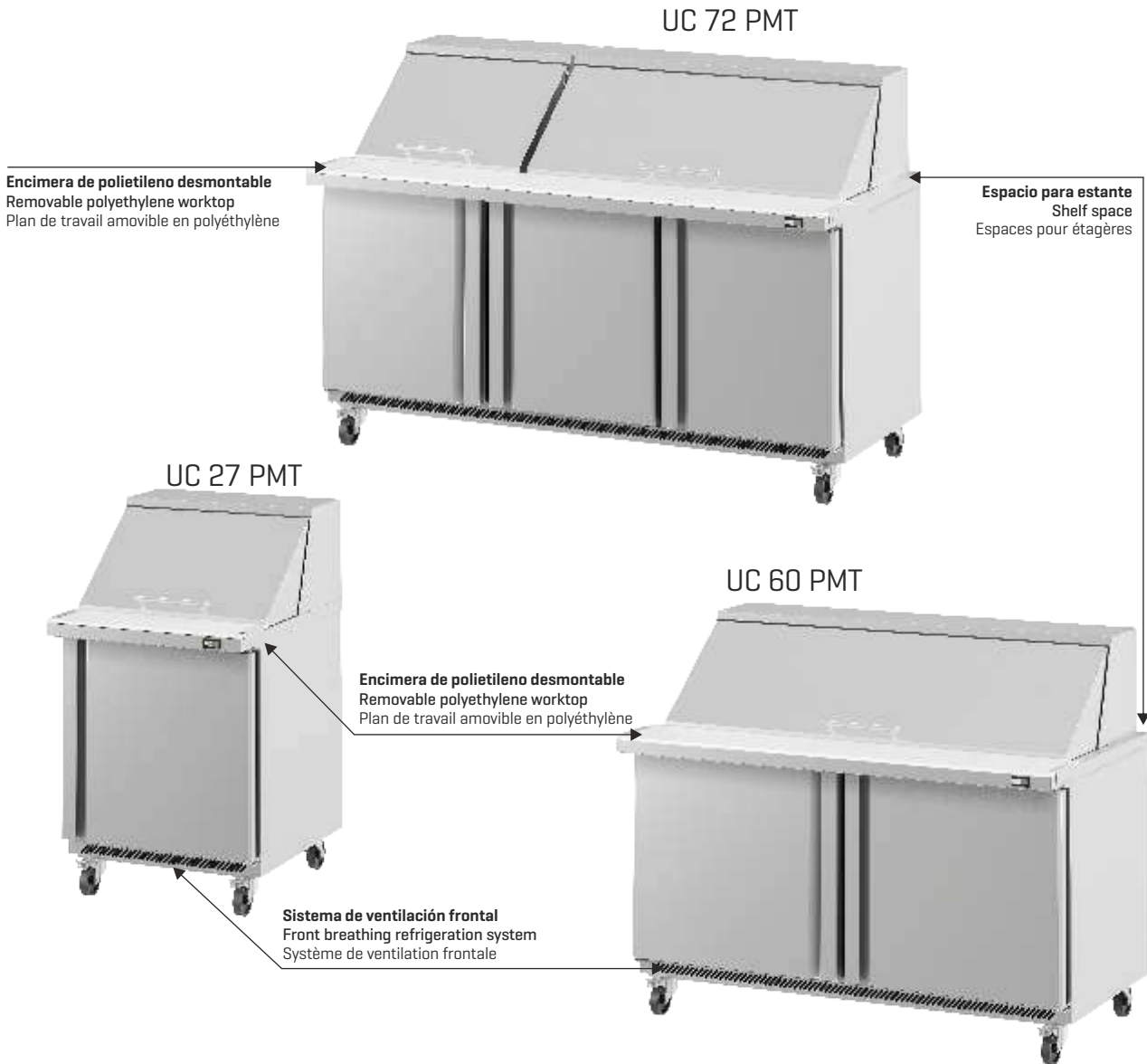

**Combinación de bandejas / Incluidas**  
Pans combinations / Included  
Combinaison de bacs / Inclus

**UC 27 PMT**

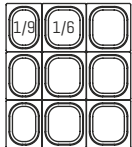

**UC 48 PMT**

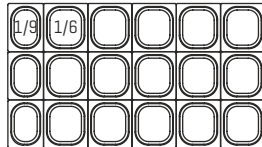

**UC 60 PMT**

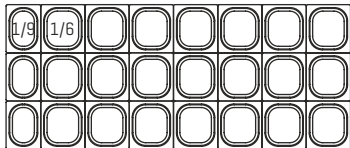



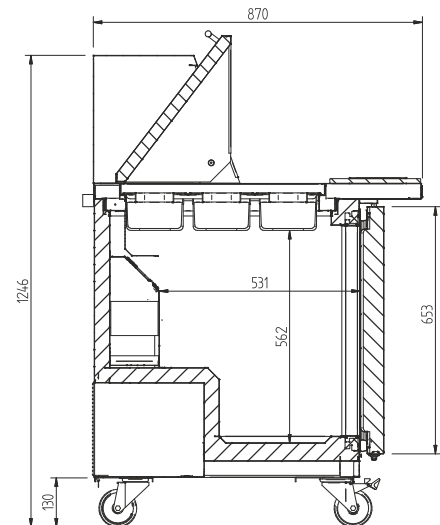
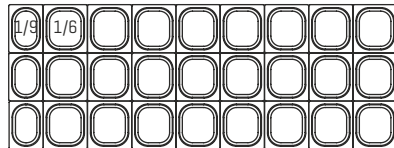

**UC 72 PMT**



# Mesas Worktop de refrigeración y congelación / Worktop refrigerator and freezer / Table Worktop positive et négative

REFRIG / REFRIG / POSIT

CONGEL / FREEZ / NÉGAT

MODELO MODELE MODÈLE	 MR 41	 MR 67	 MR 93	 MR 41 BT	 MR 67 BT
<b>Precio</b> Price Prix					
<b>Medidas</b> Measures Mesures (mm)	1050 x 830 x 1007 mm.	1710 x 830 x 1007 mm.	2370 x 830 x 1007 mm.	1050 x 830 x 1007 mm.	1710 x 830 x 1007 mm.
<b>Temperatura</b> Temperature Temperature (°C)	-2°C / +8°C			-18°C	
<b>Clase Climática</b> Climatic class Classe climatique (°C)	5 / 40° C				
<b>Tensión/Frecuencia</b> Electrical data Tension électrique	230V/1ph/50Hz				
<b>Material</b> Material Matériel (EXT/INT)	AISI 430 Encimera / Worktop / Dessus AISI 304				
<b>Espesor</b> Thickness Épaisseur (mm)	55				
<b>Capacidad</b> Capacity Capacité	220	480	765	220	480
<b>Puertas</b> Doors Portes	1	2	3	1	2
<b>Nº parrillas J. guías</b> N° shelves / Slides N° de grilles / Glissière	2 (510 x 650)	4 (510 x 650)	6 (510 x 650)	2 (510 x 650)	4 (510 x 650)
<b>Nº Bandejas</b> N° Pans N° Containers	-				
<b>Evaporación</b> Evaporation Evaporation	Ventilado / Ventilated / Ventilé				
<b>Desescarche</b> Defrost Dégivrache	Parada compresor / Compresor off / Arrêt compresseur.			Gas caliente / Hot gas / Gaz chaud	
<b>Potencia</b> Power Puissance (W)	212	370		458	678
<b>Potencia frig.</b> Cooling capacity Puissance Frig. (-10°/30°C BT) (W A)	370	690		445	580
<b>Refrigerante</b> Refrigerant Gaz	R-290				
<b>Opcional</b> Optional Options	Parrilla / Wire shelf / Grille [502X77] Patas / Legs / Pieds [506X42] Kit cajones / Drawer kit / Kit tiroirs [JCAJ10MR442C] Juego de Guías / Set of Sliders / Jeu de Glissières [GUIA503MR01: GUIA503MR02]				
	115V/1ph/60Hz 230V/1ph/60Hz			115V/1ph/60Hz 230V/1ph/60Hz	

Serie / Series / Série **MR**

+Info: [www.infrico.com](http://www.infrico.com)

MR 93



**Cerradura de serie**  
Standard door lock  
Serrure de série

MR 67



**Encimera acero inox AISI 304**  
AISI 304 Stainless steel worktop  
Dessus acier inox AISI 304

**Control digital protegido con desescarche**  
Protected digital control with defrost  
Contrôleur digital protégé avec dégivrage

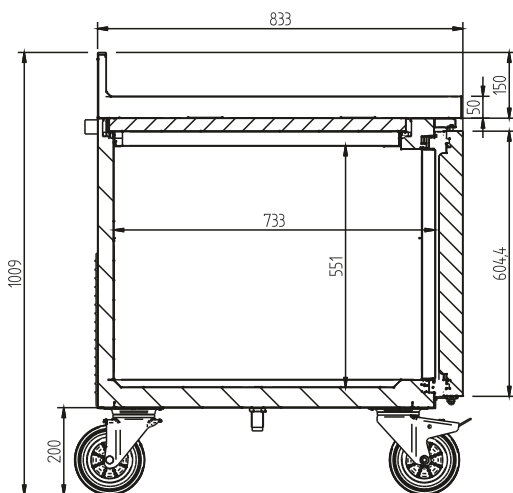

**Kit cajones opcional**  
Optional drawers kit  
Kit tiroirs en option

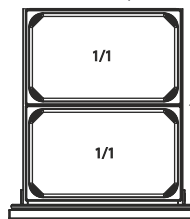

**Barra divisoria opcional**  
Optional divider bar  
Barre de division en option

Cod: 10UC2749

Cod: 10UC27134

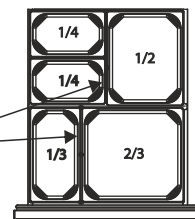

# Mesas refriger. ensaladas y pizzas / Pizza salad prep tables / Table positive prép. salades et pizzas

REFRIGERACIÓN / REFRIGERATOR / POSITIVE

MODELO  
MODELE  
MODÈLE



MR 41 EN



MR 67 EN



MR 93 EN



MR 119 EN

MODELO MODELE MODÈLE	MR 41 EN	MR 67 EN	MR 93 EN	MR 119 EN
<b>Precio</b> Price Prix				
<b>Medidas</b> Measures Mesures (mm)	1050 x 830 x 1106 mm.	1710 x 830 x 1106 mm.	2370 x 830 x 1106 mm.	3030 x 830 x 1106 mm.
<b>Temperatura</b> Temperature Temperature (°C)	0°C/+6°C			
<b>Clase Climática</b> Climatic class Classe climatique (°C)	4 / 38° C			
<b>Tensión/Frecuencia</b> Electrical data Tension électrique	230V/1ph/50Hz			
<b>Material</b> Material (EXT/INT) Matériel	Encimera / Worktop / Dessus AISI 304			
<b>Espesor</b> Thickness Épaisseur (mm)				
<b>Capacidad</b> Capacity Capacité (L)	220	480	765	1050
<b>Puertas</b> Doors Portes	1	2	3	4
<b>Nº parrillas J. guías</b> N° shelves / Slides N° de grilles / Glissière	2 (510 x 650)	4 (510 x 650)	6 (510 x 650)	8 (510x650)
<b>Nº Bandejas</b> N° Pans N° Containers	5	9	13	16
<b>Evaporación</b> Evaporation Evaporation	Ventilado / Ventilated / Ventilé			
<b>Desescarche</b> Defrost Dégivrache				Parada compresor / Compressor off / Arrêt compresseur.
<b>Potencia</b> Power Puissance (W)	370		504	
<b>Potencia frig.</b> Cooling capacity Puissance Frig. (W A) (-10°/30°C BT)	690		950	
<b>Refrigerante</b> Refrigerant Gaz	R-290			
<b>Opcional</b> Optional Options	Parrilla / Wire shelf / Grille [502X77] Patas / Legs / Pieds [506X42] Kit cajones / Drawer kit / Kit tiroirs [JCAJ10MR442C] Juego de Guías / Set of Sliders / Jeu de Glissières [GUIA503MR01: GUIA503MR02] 115V/1ph/60Hz 230V/1ph/60Hz			

Serie / Series / Série **MR EN**

+Info: [www.infrico.com](http://www.infrico.com)

MR 93 EN



Encimera de polietileno desmontable  
Removable polyethylene worktop  
Plan de travail amovible en polyéthylène

MR 41 EN



Encimera de polietileno desmontable  
Removable polyethylene worktop  
Plan de travail amovible en polyéthylène

MR 67 EN



Cerradura de serie  
Standard door lock  
Serrure de série

Combinación de bandejas / Incluidas  
Pans combinations / Included  
Combinaison de bacs / Inclus

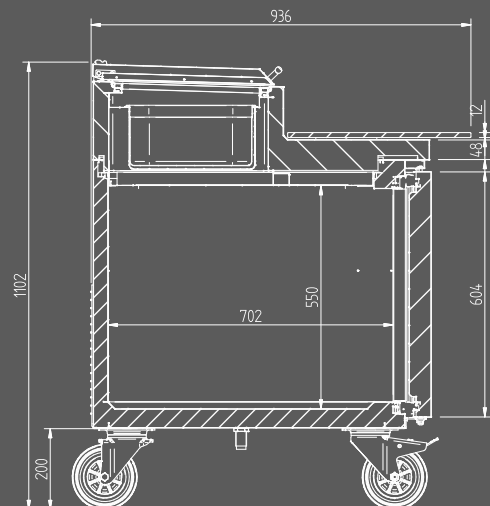

# Mesas refrigerada pizzas / Pizza prep tables / Table positive préparation pizzas

REFRIGERACIÓN / REFRIGERATOR / POSITIVE

MODELO  
MODELE  
MODÈLE



MR 67 GT COMBO



MR 93 GT COMBO



MPG 1490 COMBO



MPG 1980 COMBO

MODELO MODELE MODÈLE	MR 67 GT COMBO	MR 93 GT COMBO	MPG 1490 COMBO	MPG 1980 COMBO
<b>Precio</b> Price Prix				
<b>Medidas</b> Measures Mesures (mm)	1751 x 830 x 1508 mm.	2370 x 830 x 1508 mm.	1499 x 700 x 1543 mm.	1975 x 700 x 1543 mm.
<b>Temperatura</b> Temperature Temperature (°C)	0°C/+6°C			
<b>Clase Climática</b> Climatic class Classe climatique (°C)	4 / 38° C			
<b>Tensión/Frecuencia</b> Electrical data Tension électrique	230V/1ph/50Hz			
<b>Material</b> Material (EXT/INT) Matériel	Encimera / Worktop / Dessus AISI 304			
<b>Espesor</b> Thickness Épaisseur (mm)	70			
<b>Capacidad</b> Capacity Capacité (L)	480	765	305	465
<b>Puertas</b> Doors Portes	2	3	2	3
<b>Nº parrillas J. guías</b> N° shelves / Slides N° de grilles / Glissière	4 (510 x 650)	6 (510 x 650)	2/10 (325 x 530)	3/15 (325x530)
<b>Nº Bandejas</b> N° Pans N° Containers	6	11	6	9
<b>Evaporación</b> Evaporation Evaporation	Ventilado / Ventilated / Ventilé			
<b>Desescarche</b> Defrost Dégivrache	Parada compresor / Compressor off / Arrêt compresseur.			
<b>Potencia</b> Power Puissance (W)	370		369	553
<b>Potencia frig.</b> Cooling capacity Puissance Frig. (W A) (-10°/30°C BT)	690 + 170		370+170	690+170
<b>Refrigerante</b> Refrigerant Gaz	R-290			
<b>Opcional</b> Optional Options	Parrilla / Wire shelf / Grille [502X77] Patas / Legs / Pieds [506X42] Kit cajones / Drawer kit / Kit tiroirs [JCAJ10MR442C] Juego de Guías / Set of Sliders / Jeu de Glissières [GUIA503MR01: GUIA503MR02] 115V/1ph/60Hz 230V/1ph/60Hz			



Serie / Series / Série **GT COMBO / MPG COMBO**

+Info: [www.infrico.com](http://www.infrico.com)

MR67GTCOMBO



Encimera de granito  
Granite worktop  
Plan de travail à granite

MPG1980COMBO



**Combinación de bandejas / Incluidas**  
Pans combinations / Included  
Combinaison de bacs / Inclus

MPG1490 COMBO

[501X13] = 1 [501X11] = 4



MR67GT COMBO

[501X13] = 1 [501X11] = 5



MPG1980 COMBO

[501X11] = 8



MR93GT COMBO

[501X11] = 10

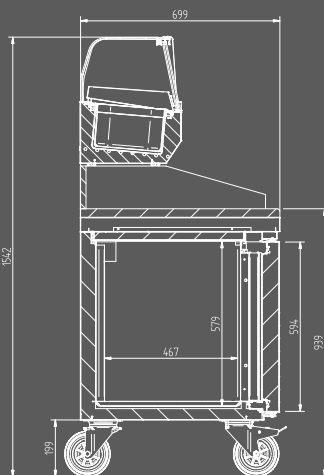



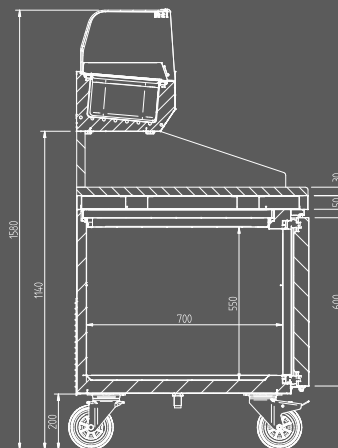



MPG COMBO



MR GT COMBO

# Mesa baja refrigeración / Chef base refrigerator / Soubassement positif

REFRIGERACIÓN / REFRIGERATOR / POSITIVE

MODELO MODELE MODÈLE						
	MSG36	MSG48	MSG52	MSG72	MSG96	MSG110
<b>Precio</b> Price Prix						
<b>Medidas</b> Measures Mesures [mm]	930 x 825 x 666 mm.	1235 x 825 x 666 mm.	1352 x 825 x 666 mm.	1845 x 825 x 666 mm.	2464 x 825 x 666 mm.	2809 x 825 x 666 mm.
<b>Temperatura</b> Temperature Temperature [°C]	0°C/+6°C					
<b>Clase Climática</b> Climatic class Classe climatique [°C]	4 / 38° C					
<b>Tensión/Frecuencia</b> Electrical data Tension électrique	230V/1ph/50Hz					
<b>Material</b> Material Matériel [EXT/INT]	Ext/Int AISI 430 Encimera / Worktop / Dessus AISI 304					
<b>Espesor</b> Thickness Épaisseur [mm]	55					
<b>Capacidad</b> Capacity Capacité [L]	148	193	280	405	584	620
<b>Cajones</b> Drawers Tiroirs	2		4		6	
<b>Nº parrillas J. guías</b> N° shelves / Slides N° de grilles / Glissière	4		6	8	12	
<b>Nº Bandejas</b> N° Pans N° Containers	2 GN1/1 + GN1/6		GN1/1			
<b>Evaporación</b> Evaporation Evaporation	Ventilado / Ventilated / Ventilé					
<b>Desescarche</b> Defrost Dégivrache	Parada de compresor / Compressor off / Arrêt du compresseur					
<b>Potencia</b> Power Puissance [W]	440			480	640	
<b>Potencia frig.</b> Cooling capacity Puissance Frig. [W A -10°C]	370				690	
<b>Refrigerante</b> Refrigerant Gaz	R-290					
<b>Opcional</b> Optional Options	Patas / Legs / Pieds [506X42] 115V/1ph/60Hz 230V/1ph/60Hz					

Serie / Series / Série **CHEF-BASES**

+Info: [www.infrico.com](http://www.infrico.com)

MSG96



Encimera acero inox AISI 304 con reborde de protección

AISI 304 Stainless steel worktop with protective flange

Dessus acier inox AISI 304 avec bride de protection



Marine Edge

MSG52

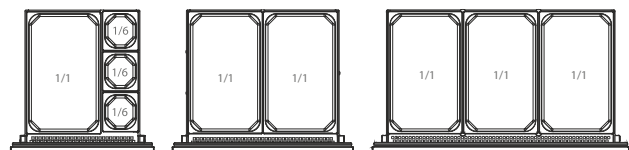

MSG36

MSG48/72/110

MSG52/96

**Barra divisoria en opción**  
Optional divider bar  
Barre de division en option

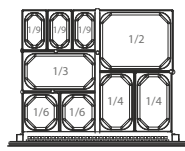

Cada cajón UC incluye una barra divisoria para las distintas configuraciones de bandejas. Hay otras barras disponibles en caso de cambio de la distribución.

Each UC drawer includes one divider bar for different pan configurations. Other divider bars are available for varying size pan distribution.

Chaque tiroir UC comprend une barres de séparation pour différentes configurations de bacs. D'autres barres de séparations sont disponibles pour la répartition de bacs de taille variable.

Encimera embutida con filo en V  
Stamped worktop with "V" edge  
Plan de travail embouti en "V"



**SOPORTA HASTA  
HOLDS UP TO  
SUPPORTE JUSQU'À**  
**450Kg**  
MSG 72, 96, 110





**SOPORTA HASTA  
HOLDS UP TO  
SUPPORTE JUSQU'À**  
**300Kg**  
MSG 36, 48, 52

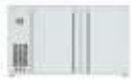

Guías telescópicas, hasta 200 kg.  
Drawers with telescopic guides up to 200 Kg.  
Glissières d'auto fermeture telescopique qui peuvent supporter jusqu'à 200 Kg.

# Frente mostrador refrigerado / Back bar coolers / Arrière bar

REFRIGERACIÓN / REFRIGERATOR / POSITIF

MODELO MODELE MODÈLE						
	ERV36IISD	ERV60IISD	ERV84IISD	ERV36IIGD	ERV60IIGD	ERV84IIGD
<b>Precio</b> Price Prix						
<b>Medidas</b> Measures Mesures [mm]	922 x 604 x 877 mm.	1543 x 604 x 877 mm.	2164 x 604 x 877 mm.	922 x 604 x 877 mm.	1543 x 604 x 877 mm.	2164 x 604 x 877 mm.
<b>Temperatura</b> Temperature Température [°C]	-2°C/+8°C			2°C/+6°C		
<b>Clase Climática</b> Climatic class Classe climatique [°C]	4 / 38° C					
<b>Tensión/Frecuencia</b> Electrical data Tension électrique	230V/1ph/50Hz					
<b>Material</b> Material [EXT/INT] Matériel	Ext/Int AISI 430					
<b>Espesor</b> Thickness Épaisseur [mm]	55					
<b>Capacidad</b> Capacity Capacité [L]	162	362	562	162	362	562
<b>Puertas</b> Doors Portes	1	2	3	1	2	3
<b>Nº parrillas J. guías</b> N° shelves / Slides N° de grilles / Glissière	2 [487x465]	4 [487x465] [610x465]	6 [487x465]	2 [487x465]	4 [487x465] [610x465]	6 [487x465]
<b>Desescarche</b> Defrost Dégivrache	Parada de compresor / Compressor off / Arrêt du compresseur					
<b>Potencia</b> Power Puissance [W]	215	235	395	225	265	435
<b>Potencia frig.</b> Cooling capacity Puissance Frig. [W A -10°C]	370		690	370		690
<b>Consumo</b> Consumption Consommation [kWh/ 24h]	1,85	2,75	3,70	-		
<b>Clase energética</b> Energy class Classe Énerg.	<b>B</b>	<b>C</b>	<b>C</b>	-		
<b>Refrigerante</b> Refrigerant Gaz	<b>R-290</b>					
<b>Opcional</b> Optional Options	Iluminación Led RGB con cambio de color (por puerta) / Led lighting RGB change of colour (per door) / LED RGB avec changement de couleur (par porte) 115V/1ph/60Hz 230V/1ph/60Hz					

Serie / Series / Série **BACK BAR**

+Info: [www.infrico.com](http://www.infrico.com)

ERV84IIGD



Grifo no disponible  
Beer tap not available  
Pompe et futs non disponibles

Cerradura de serie  
Serial Lock  
Serrure de série



ERV36IIGD



Tirador p. cristal  
Glass door handle  
Poignée p. vitrée

Control digital protegido con desescarche  
Protected digital control with defrost  
Contrôleur digital protégé avec dégivrage



# Cavas & Dry Aging

7





Serie / Series / Série  
**AN SC**



AN SC 212-213

Serie / Series / Série  
**AGB MDA**



AGB MDA  
 AGB MDAB 214-215

Serie / Series / Série  
**VC MDA**



VC MDA  
 VC MDAB 216-217

Serie / Series / Série  
**AC MDAB**



AC MDAB 218-219

Serie / Series / Série  
**AMC**



AMC L  
 AMC XL 220-221

Serie / Series / Série  
**VITRA V**



LO V 224-225

Serie / Series / Série  
**EVV/VINTAGE MODULAR**



EVV  
 EVV MX  
 EVV RG 226-227



228-229

Infrico



+Info: [www.infrico.com](http://www.infrico.com)



# 7. Cavas & Dry Aging

Doble acristalamiento templado, bajo emisor con carga de Argón [4-27-4].

Double tempered glass, low-e with argon charge [4-27-4].

Triple vitrage et verre trempé [4-12-3-12-4].



Control electrónico de Temperatura y Humedad.

Electronic Temperature and Humidity control.

Contrôle électronique de la Température et de l'Humidité.



## Iluminación / Lighting / Éclairage

Incorporación de iluminación LED, llegando a reducir el consumo energético entre un 80% y 90%, respecto a una bombilla tradicional. RGB opcional.

LED lighting incorporated, reducing energetic consumption between 80% and 90% respect to a traditional light bulb. RGB optional.

Éclairage LED, réduisant la consommation énergétique entre 80% et 90%, par rapport à une ampoule traditionnelle. RGB optionnel.



+Info: [www.infrico.com](http://www.infrico.com)

Barra carnicera.

Meat bar set.

Barre à viande.



Modelos MDA en inox AISI304 y MDAB en acero lacado negro.

Models MDA in AISI304 stainless steel and MDAB in black lacquered steel.

Modèles MDA en inox AISI304 et MDAB en acier laqué noir.

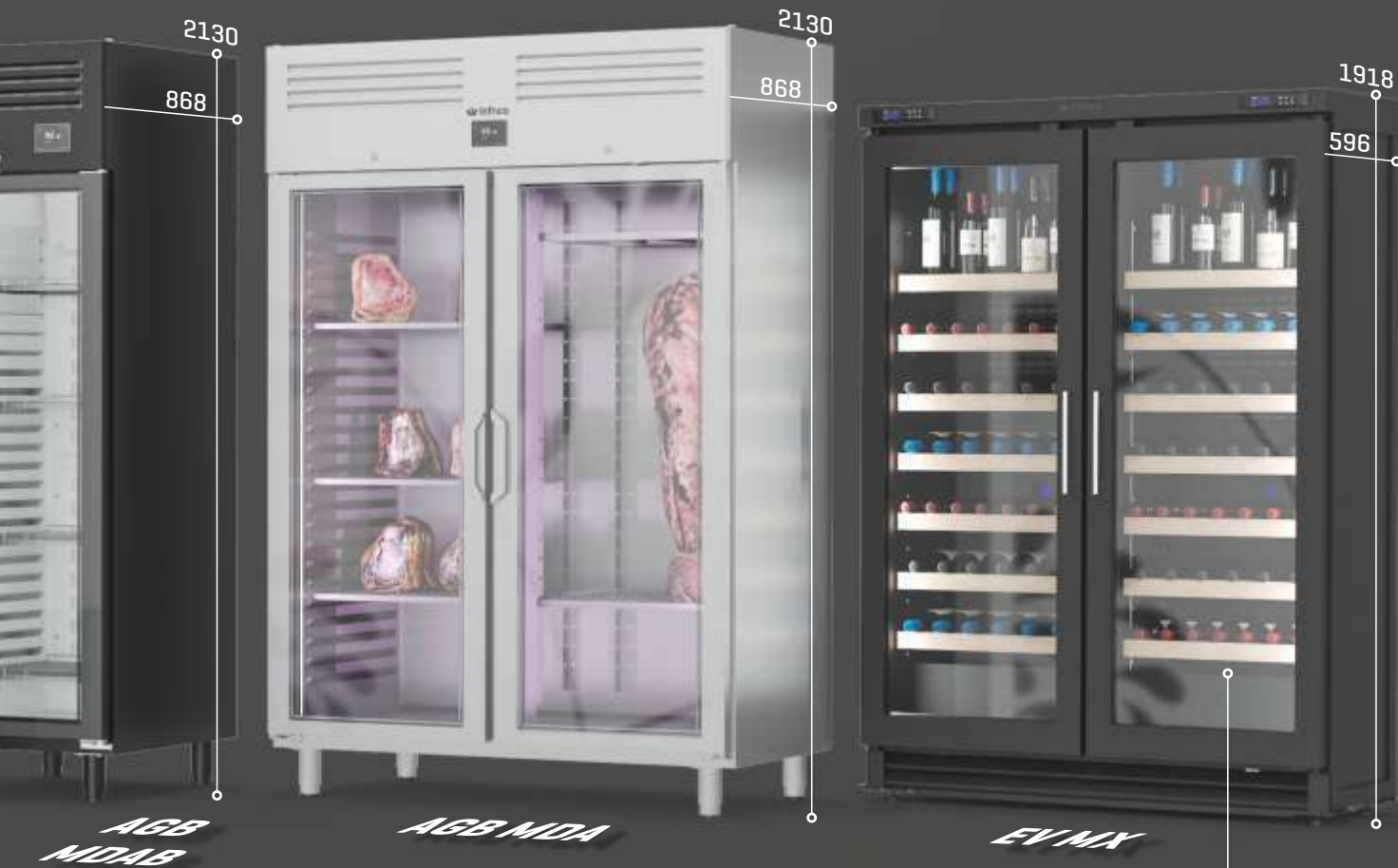

Parrillas / Grills / Grilles

Parrillas de acero lacado y madera.

Painted steels and wood grills.

Grilles en acier et en bois.

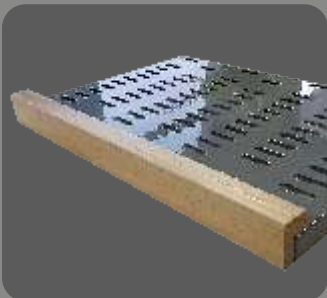

Opcional: parrillas de madera.

Optional: wood grills.

En option: Grilles en bois

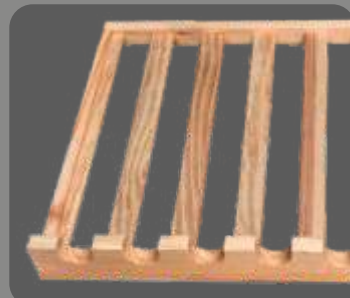

# Armario secadero embutidos / Seasoning refrigerator / Armoire séchage affinage

SECADERO / SEASONING / SÉCHAGE



AN501 SC



AN1002 SC

MODELO MODELE MODÈLE	AN501 SC	AN1002 SC
<b>Precio</b> Price Prix		
<b>Medidas</b> Measures [mm] Mesures	687 x 700 x 2060 mm.	1385 x 700 x 2060 mm.
<b>Temperatura</b> Temperature Température	+4°C/+16°C	
<b>Clase Climática</b> Climatic class Classe climatique	4 / 38°C	
<b>Tensión/Frecuencia</b> Electrical data Tension électrique	230V/1ph/50Hz	
<b>Controlador</b> Controller Régulateur	Digital IP65	
<b>Material</b> Material [EXT/INT] Matériel	AISI 304	
<b>Espesor</b> Thickness Épaisseur	55	
<b>Aislamiento</b> Isolation Isolation	40kg/m <sup>3</sup> / Free CFC's / Zero ODP-GWP	
<b>Capacidad</b> Capacity Capacité	500	1110
<b>Puertas</b> Doors Portes	1	2
<b>Nº parrillas / Guías</b> Nº shelves / Slides Nº de grilles / Glissière	-	-
<b>Barra carnicera</b> Bars for meat set Nº bars à viande	3	6
<b>Sistema de frío</b> Cooling System Système de froid	Forzado / Forced air / Ventilé	
<b>Desescarche</b> Defrost Dégivrage	Parada de compresor / Compresor off / Arrêt du compresseur	
<b>Expansión</b> Expansion Expansion	Capilar / Capillary / Capillaire	
<b>Potencia</b> Power Puissance	750	915
<b>Potencia frig.</b> Cooling capacity Puissance Frig.	370	690
<b>Consumo</b> Consumption Consommation	-	-
<b>Refrigerante</b> Refrigerant Gaz	R-290	
<b>Opcional</b> Optional Options	Juego de guías / Slides AN 500 [GUIAC0315470] Juego de guías / Slides AN 1000 [GUIAC0115520; GUIAC0215520] 115V/1ph/60Hz 230V/1ph/60Hz Puerta de cristal / Glass door / Porte vitrée [PUE17DGAEX-PUE17IGAEX] Cerradura / Lock / Serrure [506X209; 506X210] Barra carnicera / Meat bar set / Barre à viande [BCSEC3] [BCSEC4]	

Serie / Series / Série AN 500/1000L

+Info: [www.infrico.com](http://www.infrico.com)

AN 1002 SC



Video del producto

Product Video

Vidéo du produit



Infrico Youtube

**Control electrónico de Temperatura y Humedad**  
 Electronic Temperature and Humidity control  
 Contrôle électronique de la Température et de l'humidité

25 Kg por puerta  
 25 Kg per door  
 25 Kg par porte



BCSEC3

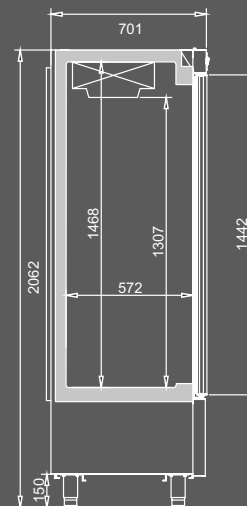

# Armario madurador Dry Aging / Dry Aging meat cabinet / Armoire maduration Dry Aging



AGB701MDA



AGB1402MDA



AGB701MDA B



AGB1402MDA B

MODELO MODELE MODÈLE	AGB701MDA	AGB1402MDA	AGB701MDA B	AGB1402MDA B
Precio Price Prix				
Medidas Measures [mm] Mesures	687 x 868 x 2130 mm.	1385 x 868 x 2130 mm.	687 x 868 x 2130 mm.	1385 x 868 x 2130 mm.
Temperatura Temperature Température	<b>T° 0°C/+16°C</b>			
Clase Climática Climatic class Classe climatique	<b>Humedad / humidity / humidité 45% HR / 85% HR</b>			
Tensión/Frecuencia Electrical data Tension électrique	4 / 38°C			
Controlador Controller Régulateur	230V/1ph/50Hz			
Material Material [EXT/INT] Matériel	AISI 304		Int: AISI 304 Ext: Acero Lacado Negro / Black Lacquered Steel / Acier Laqué Noir	
Espesor Thickness Épaisseur	75			
Aislamiento Isolation Isolation	40kg/m <sup>3</sup> / Free CFC's / Zero ODP-GWP			
Capacidad Capacity Capacité	560	1240	560	1240
Puertas Doors Portes	1	2	1	2
N° parrillas / Guías N° shelves / Slides N° de grilles / Glissière	1 barra / meat bar / barre à viande 2 estantes / shelves / étagères	2 barra / meat bar / barre à viande 4 estantes / shelves / étagères	1 barra / meat bar / barre à viande 2 estantes / shelves / étagères	2 barra / meat bar / barre à viande 4 estantes / shelves / étagères
Sistema de frío Cooling System Système de froid	Forzado / Forced air / Ventilé			
Desescarche Defrost Dégivrage	Parada de compresor / Compresor off / Arrêt du compresseur			
Expansión Expansion Expansion	Capilar / Capillary / Capillaire			
Potencia Power Puissance	870	1380	870	1380
Potencia frig. Cooling capacity Puissance Frig.	370	690	370	690
Consumo Consumption Consommation	6,35	7,34	6,35	7,34
Clase energética Energy class Classe Énerg.	-			
Refrigerante Refrigerant Gaz	<b>R-290</b>			
Opcional Optional Options	Manejo control digital bluetooth o wifi / Operating digital control bluetooth or wifi / Trait. de contrôle digital bluetooth ou wifi Ruedas / Casters / Roulettes [705X16=2; 705X17=2]			
	Barra carnicera / Meat bar set / Barre à viande [BCAN] Esterilizador UVC + Ozono / UVC + Ozone Steriliser / Stérilisateur UVC + Ozone Estantes adicionales / Additional shelves / Étagères supplémentaires 115V/1ph/60Hz 230V/1ph/60Hz			

Serie / Series / Série **AGB MDA**

+Info: [www.infrico.com](http://www.infrico.com)

AGB1402MDA



**Video del producto**

Product Video

Vidéo du produit



**Infrico Youtube**



Led de serie con tonalidad especial para carne.  
Standard LEDs with a special meat tone.  
LEDs standard avec une tonalité spéciale viande.



AGB701MDAB

Controlador digital con control de temperatura, humedad y teclado táctil.  
Digital controller with temperature, humidity control and touch keyboard.  
Contrôleur digital tactile, avec contrôle de la température et de l'humidité.

**Control electrónico de Temperatura y Humedad**  
Electronic Temperature and Humidity control  
Contrôle électronique de la Température et de l'humidité

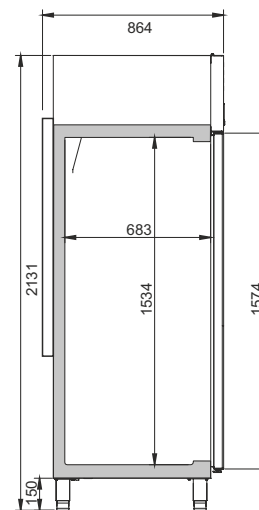

# Vitrina de maduración Dry Aging / Dry Aging meat display case / Vitrine maduration Dry Aging



VC 1400 MDA



VC 1400 MDAB



VC 2010 MDA

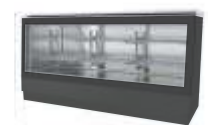

VC 2010 MDAB

MODELO MODELE MODÈLE	VC 1400 MDA	VC 1400 MDAB	VC 2010 MDA	VC 2010 MDAB
<b>Precio</b> Price Prix				
<b>Medidas</b> Measures [mm] Mesures	1384 x 740 x 1060 mm.	1384 x 740 x 1060 mm.	2100 x 740 x 1060 mm.	2100 x 740 x 1060 mm.
<b>Temperatura</b> Temperature Température	<b>+0°C/+16°C</b>			
<b>Clase Climática</b> Climatic class Classe climatique	<b>Humedad / humidity / humidité 45% HR / 85% HR</b>			
<b>Tensión/Frecuencia</b> Electrical data Tension électrique	4 / 38°C			
<b>Controlador</b> Controller Régulateur	230V/1ph/50Hz			
<b>Material</b> Material [EXT/INT] Matériel	AISI 304	Int + tapa/lid/couvercle: AISI 304 Ext: Acero Lacado Negro / Black Lacquered Steel / Acier Laqué Noir	AISI 304	Int + tapa/lid/couvercle: AISI 304 Ext: Acero Lacado Negro / Black Lacquered Steel / Acier Laqué Noir
<b>Espesor</b> Thickness Épaisseur	Digital IP65			
<b>Aislamiento</b> Isolation Isolation	70			
<b>Capacidad</b> Capacity Capacité	40kg/m <sup>3</sup> / Free CFC's / Zero ODP-GWP			
<b>Puertas</b> Doors Portes	470	470	710	710
<b>Nº Estantes</b> Shelves Nº Étagères	1	1	1	1
<b>Barra carnicera</b> Bars for meat set Nº bars à viande	4	4	6	6
<b>Sistema de frío</b> Cooling System Système de froid	-	-	-	-
<b>Desescarche</b> Defrost Dégivrage	Forzado / Forced air / Ventilé			
<b>Expansión</b> Expansion Expansion	Parada de compresor / Compresor off / Arrêt du compresseur			
<b>Potencia</b> Power Puissance	Capilar / Capillary / Capillaire			
<b>Potencia frig.</b> Cooling capacity Puissance Frig.	551	551	557	557
<b>Consumo</b> Consumption Consommation	687	687	687	687
<b>Refrigerante</b> Refrigerant Gaz	-			
<b>Opcional</b> Optional Options	R-290			
	<p><b>Puerta de cristal</b> (Dcha.-Right-Droite) KPUIDVCCR Glass door (unit) (Izq.-Left-Gauche) KPUIIVCCR Porte vitrée (unit)</p> <p><b>Cerradura puerta ciega</b> (506X120; 506X121) Solid door lock Serrure porte inox</p> <p><b>Cerradura puerta cristal</b> (506X60) Glass door lock Serrure porte vitrée</p> <p>115V/1ph/60Hz 230V/1ph/60Hz</p>			



Serie / Series / Série VC

+Info: [www.infrico.com](http://www.infrico.com)

VC 2010 MDAB



Led de serie con tonalidad especial para carne.  
Standard LEDs with a special meat tone.  
LEDs standard avec une tonalité spéciale viande.



Puerta abatible para un acceso y limpieza más fácil.  
Swing door for easy access and cleaning.  
Porte battant pour un accès et un nettoyage faciles.

VC 1400 MDA



Puertas traseras de retorno automático, y bisagra con bloqueo.  
Automatic return rear doors, and locking hinge.  
Portes arrière à retour automatique, et charnière de blocage.

VC 2010 MDA

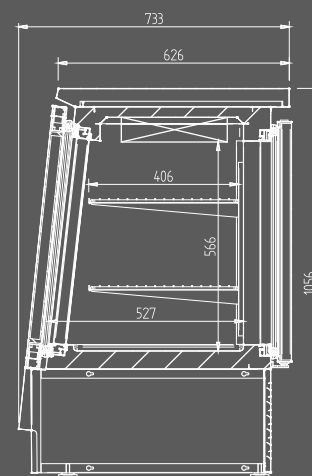

# Armario madurador Dry Aging / Dry Aging meat cabinet / Armoire maturation Dry Aging



AC 140 MDAB



AC 280 MDAB

MODELO  
MODELE  
MODÈLE

Precio Price Prix		
Medidas Measures [mm] Mesures	600 x 680 x 824 mm.	600 x 656 x 1645 mm.
Temperatura Temperature Température	T° +0°C/+16°C Humedad / humidity / humidité 45% HR / 85% HR	
Clase Climática Climatic class Classe climatique	4 / 38°C	
Tensión/Frecuencia Electrical data Tension électrique	230V/1ph/50Hz	
Controlador Controller Régulateur	Digital IP65	
Material Material [EXT/INT] Matériel	Int: AISI 304 Ext: Acero Lacado Negro / Black Lacquered Steel / Acier Laqué Noir	
Espesor Thickness Épaisseur	50	
Aislamiento Isolation Isolation	40kg/m <sup>3</sup> / Free CFC's / Zero ODP-GWP	
Capacidad Capacity Capacité	141	340
Puertas Doors Portes	1	1
N° Estantes Shelves N° Étagères	1	3
Sistema de frío Cooling System Système de froid	Forzado / Forced air / Ventilé	
Desescarche Defrost Dégivrage	Parada de compresor / Compresor off / Arrêt du compresseur	
Expansión Expansion Expansion	Capilar / Capillary / Capillaire	
Potencia Power Puissance	115	720
Potencia frig. Cooling capacity Puissance Frig.	195	343
Consumo Consumption Consommation	-	
Clase energética Energy class Classe Énerg.	-	
Refrigerante Refrigerant Gaz	R-290	
Opcional Optional Options	<p>Manejo control digital bluetooth o wifi / Operating digital control bluetooth or wifi / Trait. de contrôle digital bluetooth ou wifi</p> <p>Estantes adicionales / Additional shelves / Étagères supplémentaires</p> <p>Ruedas / Casters / Roulettes (705X16=2; 705X17=2)</p> <p>115V/1ph/60Hz</p> <p>230V/1ph/60Hz</p>	

Serie / Series / Série **AC**

+Info: [www.infrico.com](http://www.infrico.com)

AC 280 MDAB



AC 140 MDAB

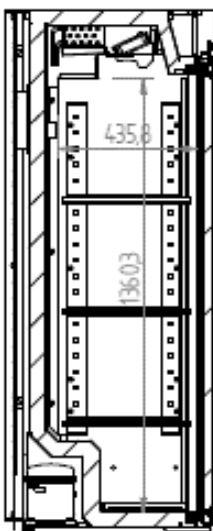

Led de serie con tonalidad especial para carne.  
Standard LEDs with a special meat tone.  
LEDs standard avec une tonalité spéciale viande.

**Control electrónico de Temperatura y Humedad**  
Electronic Temperature and Humidity control  
Contrôle électronique de la Température et de l'humidité



# Armario de maduración de carne / Dry-aging meat cabinets / Armoire de maturation pour la viande



MODELO/MODELE/MODÈLE	AMC6711L	AMC6714L	AMC8711L	AMC8714L	AMC6711XL	AMC6714XL	AMC8711XL	AMC8714XL
<b>Precio</b> Price Prix								
<b>Medidas</b> Measures [mm] Mesures	650 650 1900	650 650 1900	850 650 1900	850 650 1900	650 650 2300	650 650 2300	850 650 2300	850 650 2300
<b>Tensión/Frecuencia</b> Electrical data [V/Hz] Tension électrique	220/50							
<b>Material</b> Material Matériel	Triple cristal sin perfilera en aluminio, excepto puerta en doble cristal. Tratamiento para evitar entrada de rays U.V.A. Triple glazing without aluminum profiles, except door in double glazing. Treatment to avoid U.V.A rays. Triple vitrage sans profilera en aluminium, sauf porte double vitrage. Traitement pour éviter l'entrée des rayons U.V.A.							
<b>Capacidad</b> Capacity Capacité	450		600			780		
<b>Caras de cristal</b> Glass sides Faces vitrées	1	4	1	4	1	4	1	4
<b>Puertas</b> Doors Portes	1	1	1	1	1	1	1	1
<b>Temperatura</b> Temperature [30°C] Température	+2°C / +6°C							
<b>Potencia</b> Power [W] Puissance	992	992	997	997	1260	1260	1265	1265
<b>Refrigerante</b> Refrigerant Gaz	HC R290							
<b>Opcional</b> Optional Options	<p><b>[MODEL L] Kit ensamblaje [1 Kit cada 2 armarios] / Assembly kit [1 kit per 2 cupboards] / Kit de montage [1 kit pour 2 armoires]</b>  <b>[MODEL XL] Kit ensamblaje [1 Kit cada 2 armarios] / Assembly kit [1 kit per 2 cupboards] / Kit de montage [1 kit pour 2 armoires]</b></p> <p>(mod. 650x1900 mm) <b>Decor. Negra/Blanca/Brown Rusty / Decor. Black/White/Brown Rusty / Décor. noire/blanche/Marron Rusty</b>  (mod. 850x1900 mm) <b>Decor. Negra/Blanca/Brown Rusty / Decor. Black/White/Brown Rusty / Décor. noire/blanche/Marron Rusty</b>  (mod. 650x2300 mm) <b>Decor. Negra/Blanca/Brown Rusty / Decor. Black/White/Brown Rusty / Décor. noire/blanche/Marron Rusty</b>  (mod. 850x2300 mm) <b>Decor. Negra/Blanca/Brown Rusty / Decor. Black/White/Brown Rusty / Décor. noire/blanche/Marron Rusty</b></p>  <p><b>Kit SIN MADURACIÓN / Kit WITHOUT DRY AGING / Kit SANS MATURATION</b></p>							

## A DESTACAR

La maduración en seco es una técnica de envejecimiento en seco de la carne con temperatura y humedad controladas. Con la maduración en seco, la carne en 5-8 semanas pierde del 10% al 20% de los líquidos.

La vitrina Dry Aged trabaja en un régimen de temperatura de +2°C a +6°C con humedad controlada del 45% al 80%.

Gama de armarios diseñados para la maduración de la Carne [+2 °C a +6 °C], con sistema de refrigeración ventilado.

Termostato SOFT TOUCH con pantalla gráfica de 2.8" y teclado táctil, control de humedad de serie.

Disponible en dos longitudes 650mm y 850mm, grupo frigorífico en la parte inferior AMC 67/87L o superior AMC67/87XL.

Doble barra carnicera y tres estantes de acero cromado o cristal [a elegir].

Modelos canalizables, hasta un máximo de 2 puertas. Estructura con ruedas.

Iluminación con doble tira de LED, tonalidad especial para carne.

## BENEFITS

Dry ripening is a dry aging technique of meat with controlled temperature and humidity. With the maturation in dry, the meat in 5-8 weeks loses from 10% to 20% of the liquids.

The Dry Aged showcase works in a field of +2°C +6°C with controlled humidity of 45% to 80%.

Range of cabinets designed for the dry-aging meat [+ 2°C to + 6 °C], with ventilated cooling system.

SOFT TOUCH thermostat with 2.8 "graphic display and touch screen, humidity control standard.

Available in two lengths 650mm and 850mm, refrigeration unit in the lower part AMC 67/87L and in the upper part AMC67/87XL.

Double meat bar and and three chromed or glass shelves [free choice].

Modularity, there is the possibility of channeling different models independently of their size with the Assembly Kit, up to a maximum of 2 doors.

Structure with wheels.

Lighting with double LED strip, special tonality for meat.

## À SOULIGNER

Gamme d'armoires conçue pour la maturation de la viande [+2°C jusqu'à +6°C], avec système de réfrigération ventilé.

Nouveau thermostat SOFT TOUCH avec écran graphique de 2,8" et clavier tactile interactif, contrôle d'humidité de série.

Finition standard SILVER QUARTZ, ou sur commande en NOIR OPAL et BLANC PERLE.

Disponible en deux longueurs 650mm et 850mm, groupe frigorifique en bas AMC 67/87L ou en haut AMC 67/87XL.

Modularité, il existe la possibilité de canaliser différents modèles indépendamment de leur dimension grâce à kit de montage, maximum 3 portes.

Structure avec roulettes.

Éclairage avec double LED spécial pour viande.

Serie / Series / Série **AMC**

+Info: [www.infrico.com](http://www.infrico.com)

AMC8714XL

**Modelo con unidad  
frigorífica arriba  
Negro Opcional**

Model with  
refrigeration unit  
on top  
Black Optional

Modèle avec  
unité de  
refroidissement  
au-dessus.  
Noir en option



AMC6714XL

**Modelo Estándar  
Silver Quartz**

Standard model  
Silver Quartz

Modèle Standard  
Silver Quartz





7

+Info: [www.infrico.com](http://www.infrico.com)



# Armarios expositores de vino / Wines exhibiting cupboard / Armoire d'exposition pour le vin



MODELO/MODELE/MODÈLE	L06511V	L06512V	L06513V	L06514V	L08511V	L08512V	L08513V	L08514V
<b>Precio</b> Price Prix								
<b>Medidas</b> Measures (mm) Mesures	650 650 2300	650 650 2300	650 650 2300	650 650 2300	850 650 2300	850 650 2300	850 650 2300	850 650 2300
<b>Tensión/Frecuencia</b> Electrical data (V/Hz) Tension électrique	220/50							
<b>Material</b> Material Matériel	Triple cristal excepto la puerta en doble cristal, cristal exterior e interior bajo emisivo. Triple crystal except the door in double glass, exterior glass and interior low emissive. Triple vitrage à l'exception de la porte qui est en double vitrage, vitrage extérieur et intérieur de faible émissivité.							
<b>Capacidad</b> Capacity Capacité	600 [120 Botellas]				780 [160 Botellas]			
<b>Caras de cristal</b> Glass sides Faces vitrées	1	2	3	4	1	2	3	4
<b>Puertas</b> Doors Portes	1	1	1	1	1	1	1	1
<b>Estantes</b> Shelves Étagères	3	3	3	3	3	3	3	3
<b>Temperatura</b> Temperature (30°C) Température	+4°C / +18°C							
<b>Condensación</b> Condensation Condenseur	Ventilada / Ventilated / Ventilée							
<b>Evaporación</b> Evaporation Évaporateur	Ventilada / Ventilated / Ventilée							
<b>Desescarche</b> Defrost (Kg.) Dégivrage	Automático / Automatic / Automatique							
<b>Potencia</b> Power (W) Puissance	1260	1260	1260	1260	1265	1265	1265	1265
<b>Refrigerante</b> Refrigerant Gaz	HC R290							
<b>Opcional</b> Optional Options	<p>Kit ensamblaje [1 Kit cada 2 armarios] / Assembly kit [1 kit per 2 cupboards] / Kit de montage [1 kit tous les 2 coffrets]</p> <p>Estructura plexiglás 90° [120 botellas] / 90° plexiglass structure [120 bottles] / Structure en plexiglas 90° [120 bouteilles]</p> <p>Estructura plexiglás 45° [66 botellas] / 45° plexiglass structure [66 bottles] / Structure en plexiglas 45° [66 bouteilles]</p> <p>Decoración Negra/Blanca/Brown Rusty / Decoration Black/White/Brown Rusty / Décoration noire/blanche/Marron Rusty [mod. 650 mm]</p> <p>Decoración Negra/Blanca/Brown Rusty / Decoration Black/White/Brown Rusty / Décoration noire/blanche/Marron Rusty [mod. 850 mm]</p>							

## A DESTACAR

Gama de armarios expositores de Vino [+4°C a +18°C].  
Disponibles en dos longitudes 650mm y 850mm, con posibilidad de 1 a 4 caras de cristal.  
Tres estantes de plexiglás regulables en altura, medidas 500x450mm (longitud 650mm), y medida 700x450mm (longitud 850mm).  
Capacidad de hasta 120 botellas o 160 botellas según modelo.  
Modelos canalizables hasta un máximo de 3 puertas.  
Estructura con ruedas.  
Iluminación con doble tira de LED con luz continua, mejora la visibilidad del producto expuesto.

## BENEFITS

Range of wine display cabinets [+4°C to +18°C].  
Available in two lengths 650mm and 850mm, with the possibility of 1 to 4 faces of glass.  
Three plexiglass shelves adjustable in height, measured 500x450mm (length 650mm), and measurement 700x450mm (length 850mm).  
Capacity up to 120 bottles or 160 bottles according to model.  
Canalisable models up to a maximum of 3 doors.  
Structure with wheels.  
Double LED strip lighting with continuous light, improves the visibility of the exposed product.

## À SOULIGNER

Gamme d'armoires d'exposition pour le vin [+4°C jusqu'à +18°C].  
Disponibles en deux largeurs 650mm et 850mm, avec possibilité de 1 à 4 faces vitrées.  
Distribution intérieure avec 3 étagères de plexiglas réglables en hauteur, dimensions 500x450mm (longueur 650mm), et dimensions 700x450mm (longueur 850mm).  
Capacité jusqu'à 120 bouteilles ou 160 bouteilles selon modèle.  
Modèles canalissables, maximum 3 portes.  
Structure avec roulettes.  
Éclairage avec double LED et lumière continue pour une meilleure visibilité du produit exposé.



Serie / Series / Série **VITRA V**

+Info: [www.infrico.com](http://www.infrico.com)



[longitud 850 mm,  
altura 1900 mm]  
Consultar precio

[wide 850 mm,  
height 1900 mm]  
Price to consult  
[850mm longueur,  
hauteur 1900mm]  
Consulter prix

**Combinación de Armarios  
Kit ensamblaje**  
Combination of cabinets  
Assembly kit  
Combinaison d'armoires  
Kit d'assemblage

**L08513V + L08513V**



Opción / Option / Option  
**Estructura plexiglás 90° y 45°  
sólo para modelos de longitud 850mm**

Plexiglass structure 90° y 45°  
only for wide 850mm models

Option structure 90° et 45° plexiglas  
seulement disponible armoires de 850 mm



[650 mm longitud,  
altura 2300 mm]  
[wide 650 mm,  
height 2300 mm]  
[650mm longueur,  
hauteur 2300mm]

[650 mm longitud,  
altura 2300 mm]  
[wide 650 mm,  
height 2300 mm]  
[650mm longueur,  
hauteur 2300mm]

**L06511V**



**L06514V**











**Termostato  
Soft touch  
Thermostat tactile**



**Expositor de vino en madera /**  
Wine cellars /  
Armoire à vin

**Expositor de vino en acero lacado /**  
Retro-wine cellars /  
Armoire à vin et gourmet

Exterior de madera maciza [Cerezo] / Solid wood exterior [Cherry] / Exterieur en bois massif [Cerisier]

MODELO MODELE MODÈLE					
	EVP70	EVP100	EVP200MX	EVP 23 R1G	EVP 49 R2G
<b>Precio</b> Price Prix					
<b>Medidas</b> [mm] Measures Mesures	600 x 656 x 1645 mm.	657 x 596 x 1918 mm.	1314 x 596 x 1918 mm.	690 x 602 x 2032 mm.	1385 x 602 x 2032 mm.
<b>Temperatura</b> Temperature Température	+4°C/+18°C				
<b>Clase Climática</b> Climatic class Classe climatique	4 / 38°C				
<b>Tensión/Frecuencia</b> Electrical data Tension électrique	230V/1ph/50Hz				
<b>Controlador</b> Controller Régulateur	Digital / Digital / Électronique IP65				
<b>Material</b> [EXT/INT] Material Matériel	Ext: Acero Lacado Negro / Black Lacquered Steel / Acier Laqué Noir Int: AISI 304	100% Madera de pino maciza / 100% Pine wood / 100% en bois de pin massif Acero plastif. gris / Grey plastic coated steel / Acier plastifié gris		100% Madera de pino maciza / 100% Pine wood / 100% en bois de pin massif Interior AISI 430 / Inetrior AISI 430 / Intérieure AISI 430	
<b>Espesor</b> Thickness Épaisseur	50	50		95	
<b>Aislamiento</b> Isolation Isolation	40kg/m <sup>3</sup> / Free CFC's / Zero ODP-GWP				
<b>Capacidad</b> Capacity Capacité	340 (L)	350	350+350	265	640
<b>Puertas</b> Doors Portes	1	1	2	1	2
<b>N° parrillas / Guías</b> N° shelves / Slides N° de grilles / Glissière	5	7	14	5	10
<b>Capacidad botellas</b> Bottle rack Nombre de bouteilles	70	100	100 + 100	90	90 + 90
<b>Sistema de frío</b> Cooling System Système de froid	Forzado / Forced air / Ventilé				
<b>Desescarche</b> Defrost Dégivrage	Parada de compresor / Compressor off / Arrêt du compresseur				
<b>Expansión</b> Expansion Expansion	Capilar / Capillary / Capillaire				
<b>Potencia</b> Power Puissance	720 (W)	335	785	255	440
<b>Potencia frig.</b> [W A -10°C] Cooling capacity Puissance Frig.	343	370		370	690
<b>Consumo</b> [kWh/ 24h] Consumption Consommation	-				
<b>Refrigerante</b> Refrigerant Gaz	R-290				
<b>Opcional</b> Optional Options		 Cerezo / Cherry / Cerisier Estándar / Standard / Standard	 Negro / Black / Noir RAL 9017 [EVP23R1G] [EVP49R2G]	 Blanco / White / Blanc RAL 9016 [EVP23R1G] [EVP49R2G]	
		115V/1ph/60Hz 230V/1ph/60Hz			
		Parrilla de madera / Wooden shelves / Gril en bois [PMADAR1P]			

Serie / Series / Série **EVV / VINTAGE**

+Info: [www.infrico.com](http://www.infrico.com)

**EVV200MX**



**Doble temperatura**  
Dual temperature  
Double température

**Video del producto**  
Product Video  
Vidéo du produit



**Infrico Youtube**

**Negro opcional**  
Optional black  
Noir en option

**EVV70**



**La temperatura recomendada para el Vino Tinto está entre 10°C y 18°C .  
Blanco, Rosado y Brut entre 4°C y 8°C.**

**Recommended temperature for red wine is 10°C to 18°C.  
White, rosé and brut is 4°C to 8°C.**

**La température recommandée, vin rouge entre 10°C à 18°C.  
Blanc, Rosé et Brut entre 4°C à 8°C.**



**EVV100**



**Parrillas de madera** ▶  
Wood grills  
Grilles en bois



◀ **Parrillas de acero lacado y madera**  
Painted steels and wood grills  
Grilles en acier et en bois



**Blanco opcional**  
Option white  
Blanc en option



**EVV 49 R2G**



**Expositor Modular de Cristal climatizado con control de Humedad /**  
Modular Glass Display Cabinet with Humidity control /  
Expositeur modulaire en vitre avec contrôle de l'humidité



7

+Info: [www.infrico.com](http://www.infrico.com)

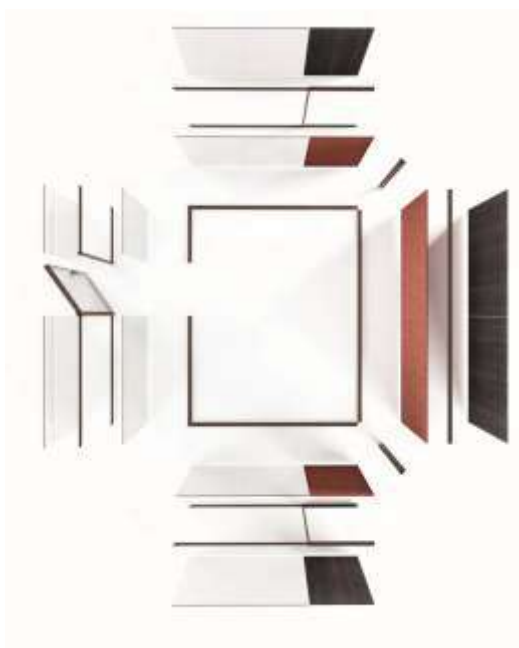

**ALUMINIUM STRUCTURE FINISHINGS**



Aluminio



Bronce



Negro opaco

**WOODEN PANELS FINISHINGS**

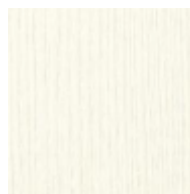

Artico



Moka



Caramelo

**A DESTACAR**















Expositores Modular de cristal para Vino Tinto (+15°C a +18°C) y humedad (50/70%)  
 Paneles disponibles en dos dimensiones: 50x230cm y 100x230cm.  
 Paneles de Vidrio de 2 hojas laminado de 5+5  
 Fácil instalación sobre suelo  
 Estructura de aluminio, guías de suelo y techo, escuadras e intersección.  
 Tres acabados de panel de madera y perfiles de aluminio.

**BENEFITS**

Modular glass displays for red wine (+15°C to +18°C) and humidity (50/70%).  
 Panels available in two sizes: 50x230cm and 100x230cm.  
 5+5" double laminated glass panels.  
 Easy installation on the floor  
 Aluminium structure, floor and ceiling guides, brackets and intersection.  
 Three finishes of wood panels and aluminium profiles.

**À SOULIGNER**

Présentoirs modulaires en verre pour le vin rouge (+15°C à +18°C) et l'humidité (50/70%).  
 Panneaux disponibles en deux tailles : 50x230cm et 100x230cm.  
 Panneaux en double verre feuilleté de 5+5".  
 Installation facile au sol  
 Structure en aluminium, guides au sol et au plafond, supports et intersection.  
 Trois finitions de panneaux en bois et de profils en aluminium.

		 cm		 u.f.	 m <sup>3</sup>	 kw
WN1515		↔ 165 ↗ 165 ↓ 240	+15/+18°C	50/70%	5,3	1
WN2010		↔ 215 ↗ 115 ↓ 240	+15/+18°C	50/70%	4,6	1
WN2015		↔ 215 ↗ 165 ↓ 240	+15/+18°C	50/70%	6,9	1
WN2020		↔ 215 ↗ 215 ↓ 240	+15/+18°C	50/70%	9,2	1
WN2525		↔ 265 ↗ 265 ↓ 240	+15/+18°C	50/70%	14,4	2
WN3015		↔ 315 ↗ 165 ↓ 240	+15/+18°C	50/70%	10,3	2
WN3020		↔ 315 ↗ 215 ↓ 240	+15/+18°C	50/70%	13,8	2





7



# Vitrinas Expositoras

Display cases / Vitrines d'exposition







Serie / Series / Série

## VEB/VEP



VEP P  
VEB CC  
VEB CP

238-241

Serie / Series / Série

## VET



VET P  
VET DP  
VET GR

VET DP GR 242-243

Serie / Series / Série

## VSU



VSU P

VSU PR 244-245

Serie / Series / Série

## VIP



VIP 1/4 C  
VIP 1/4 T  
VIP 1/3 C

VIP 1/3 T 246-249

Serie / Series / Série

## VMS



VMS I 250-251

Serie / Series / Série

## VC



VC 250-251

Serie / Series / Série

## VRP / VML Málaga



VRP  
VML 252-253

Serie / Series / Série

## JULIET



VJU 254-255

Serie / Series / Série

## VMB Marbella



VMB RU/RIU  
VMB RUP/RIUP  
VMB C/M 256-257-260

Serie / Series / Série

## VMC Mallorca



VMC RU/RIU  
VMC C/M 258-259-260

+Info: [www.infrico.com](http://www.infrico.com)



# 8. Vitrinas Expositoras

## Display cases / Vitrines d'exposition

Estructura de cristales de alta transparencia, rectos o curvos según modelo.

High transparency glass structure, flat or curved depending on the model.

Structure en verre à haute transparence, droite ou bombée selon le modèle.

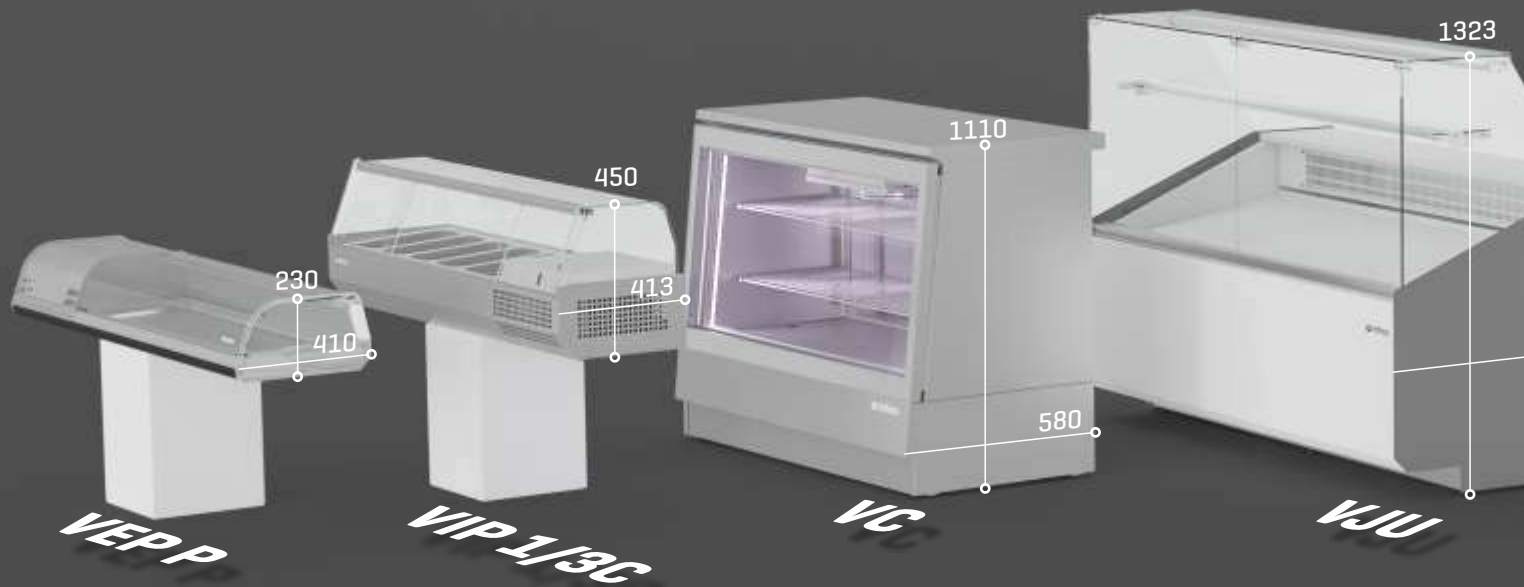

### Iluminación / Lighting / Éclairage

Incorporación de iluminación LED, llegando a reducir el consumo energético entre un 80% y 90%, respecto a una bombilla tradicional.

LED lighting incorporated, reducing energetic consumption between 80% and 90% respect to a traditional light bulb.

Éclairage LED, réduisant la consommation énergétique entre 80% et 90%, par rapport à une ampoule traditionnelle.



+Info: [www.infrico.com](http://www.infrico.com)

Equipos con posibilidad de grupo remoto y grupo incorporado.

Devices with the possibility of remote group and integrated group.

Équipement avec la possibilité de groupe à distance et de groupe incorporé.

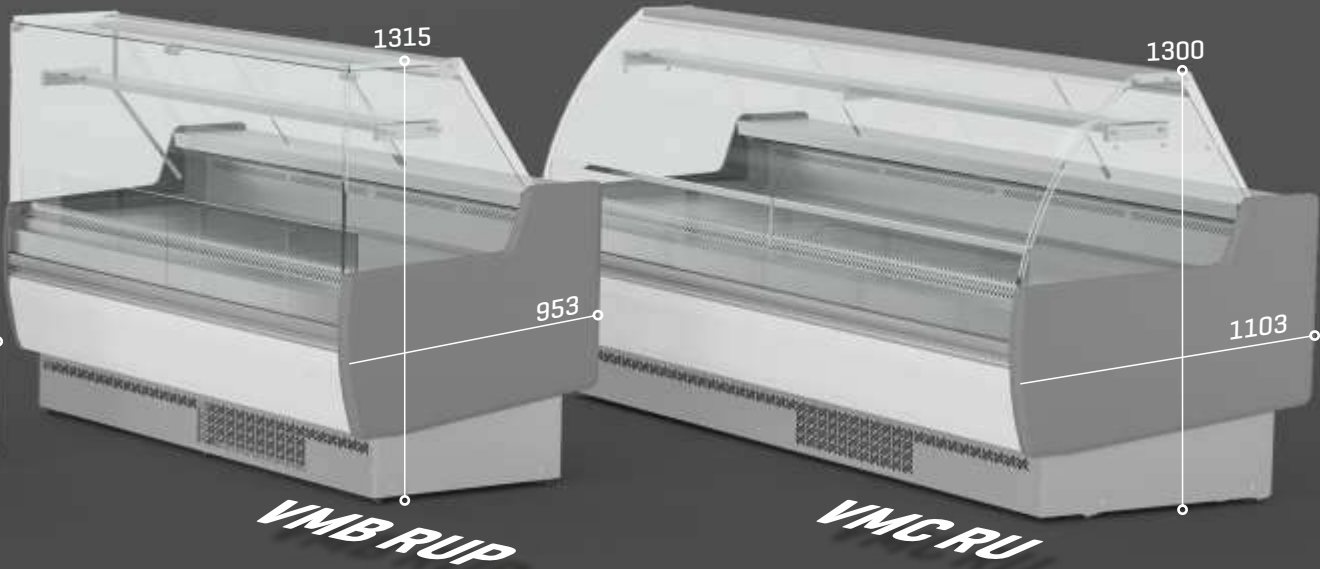

Máxima visibilidad de producto expuesto.

Maximum visibility of displayed product.

Visibilité maximale du produit exposé.



# Expositor de barra y platos / Bar display exhibitor case and plate / Vitrine à tapas

MODELO MODELE MODÈLE	VEP				VEB			
	VEP 4 P	VEP 6 P	VEP 8 P	VEB 4 CC	VEB 6 CC	VEB 7 CC	VEB 8 CC	VEB 9 CC
Precio Price Prix								
Medidas Measures Mesures (mm)	1268 x 410 x 230 mm.	1620 x 410 x 230 mm.	1972 x 410 x 230 mm.	810 x 415 x 195 mm.	1162 x 415 x 195 mm.	1338 x 415 x 195 mm.	1514 x 415 x 195 mm.	1690 x 415 x 195 mm.
Temperatura Temperature Température (°C)	-1°C/+7°C							
Clase Climática Climatic class Classe climatique (°C)	4 / 38°C							
Tensión/Frecuencia Electrical data Tension électrique	230V/1ph/50Hz							
Controlador Controller Régulateur	Digital							
Material Material Matériel (EXT/INT)	Aluminio anodizado / Anodized aluminium / Aluminium anodisé Inox AISI 304							
Espesor Thickness Épaisseur (mm)	70							
Aislamiento Isolation Isolation (mm)	40kg/m <sup>3</sup> / Free CFC's / Zero ODP-GWP							
Capacidad Capacity Capacité (L)	9,2	13,6	18,4	9,2	13,6	16,0	18,4	20,4
Superficie exposición Surface exhibition Surface d'exposition (m <sup>2</sup> )	0,23	0,34	0,46	0,23	0,34	0,40	0,46	0,51
Nº puertas Doors Nº de portes	2			1				
Sistema de frío Cooling System Système de froid	Ventilado / Ventilated / Ventilé							
Desescarche Defrost Dégivrage	Manual / Manual / Manuel							
Expansión Expansion Expansion	Capilar / Capillary / Capillaire							
Potencia Power Puissance (W)	129	131	133	129	131	132	132	133
Potencia frig. Cooling capacity Puissance Frig. (W A -10°C)	169							
Consumo Consumption Consommation (kWh/ 24h)	1,93	1,96	1,99	1,93	1,95	1,97	1,98	2,00
Área refrigerada Refrigerated area Zone réfrigérée (m <sup>2</sup> )	0,39	0,5	0,61	0,24	0,35	0,4	0,45	0,51
Refrigerante Refrigerant Gaz	R-600							
Opcional Optional Options	-							

Serie / Series / Série **VEP & VEB**

+Info: [www.infrico.com](http://www.infrico.com)

VEB 8 CC



**Expositor encastrable**  
Drop-in exhibitor  
Présentoir encastrable

VEP 6 P

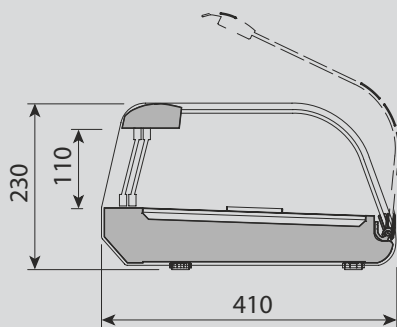



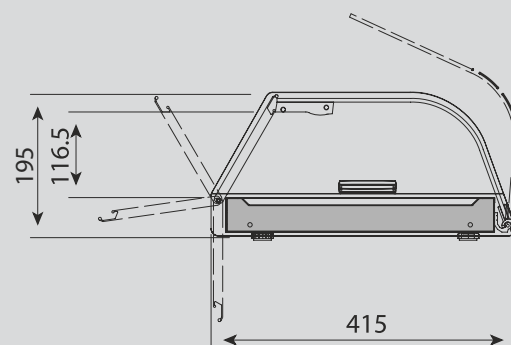

VEP P



VEB CC

# Expositor de barra y platos / Bar display exhibitor case and plate / Vitrine à tapas

MODELO MODELE MODÈLE					
	VEB 4 CP	VEB 6 CP	VEB 7 CP	VEB 8 CP	VEB 9 CP
<b>Precio</b> Price Prix					
<b>Medidas</b> Measures [mm] Mesures	810 x 395 x 195 mm.	1162 x 395 x 195 mm.	1338 x 395 x 195 mm.	1514 x 395 x 195 mm.	1690 x 395 x 195 mm.
<b>Temperatura</b> Temperature [°C] Température	-1°C/+7°C				
<b>Clase Climática</b> Climatic class [°C] Classe climatique	4 / 38°C				
<b>Tensión/Frecuencia</b> Electrical data Tension électrique	230V/1ph/50Hz				
<b>Controlador</b> Controller Régulateur	Digital				
<b>Material</b> Material [EXT/INT] Matériel	Aluminio anodizado / Anodized aluminium / Aluminium anodisé Inox AISI 304				
<b>Espesor</b> Thickness [mm] Épaisseur	70				
<b>Aislamiento</b> Isolation [mm] Isolation	40kg/m <sup>3</sup> / Free CFC's / Zero ODP-GWP				
<b>Capacidad</b> Capacity [L] Capacité	9,2	13,6	16,0	18,4	20,4
<b>Superficie exposición</b> Surface exhibition [m <sup>2</sup> ] Surface d'exposition	0,23	0,34	0,40	0,46	0,51
<b>Nº puertas</b> Doors Nº de portes					
<b>Sistema de frío</b> Cooling System Système de froid	Ventilado / Ventilated / Ventilé				
<b>Desescarche</b> Defrost Dégivrage	Manual / Manual / Manuel				
<b>Expansión</b> Expansion Expansion	Capilar / Capillary / Capillaire				
<b>Potencia</b> Power [W] Puissance	129	131	132	132	133
<b>Potencia frig.</b> Cooling capacity [W A -10°C] Puissance Frig.	169				
<b>Consumo</b> Consumption [kWh/ 24h] Consommation	1,93	1,95	1,97	1,98	2,00
<b>Área refrigerada</b> Refrigerated area [m <sup>2</sup> ] Zone réfrigérée	0,24	0,35	0,4	0,45	0,51
<b>Refrigerante</b> Refrigerant Gaz	R-600				
<b>Opcional</b> Optional Options	-				



Serie / Series / Série **VEP & VEB**

+Info: [www.infrico.com](http://www.infrico.com)

VEB 6 CP



**Expositor encastrable**  
Drop-in exhibitor  
Présentoir encastrable



VEB 6 CP



VEB 4 CP

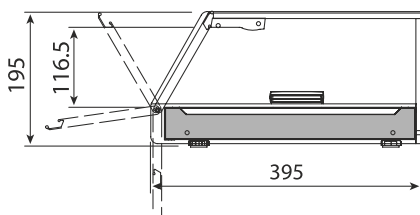

# Expositor de tapas y pintxos / Bar display exhibitor case and plate / Vitrine à tapas

MODELO  
MODELE  
MODÈLE



VET 4 P VET 6 P VET 8 P VET 4 DP VET 6 DP VET 8 DP VET 7 P GR VET 9 P GR VET 7 DP GR VET 9 DP GR

	VET 4 P	VET 6 P	VET 8 P	VET 4 DP	VET 6 DP	VET 8 DP	VET 7 P GR	VET 9 P GR	VET 7 DP GR	VET 9 DP GR
<b>Precio</b> Price Prix										
<b>Medidas</b> Measures Mesures (mm)	1268 x 410 x 230 mm.	1620 x 410 x 230 mm.	1972 x 410 x 230 mm.	1268 x 412 x 330 mm.	1620 x 412 x 330 mm.	1972 x 412 x 330 mm.	1338 x 410 x 230 mm.	1690 x 410 x 230 mm.	1338 x 412 x 330 mm.	1690 x 412 x 330 mm.
<b>Temperatura</b> Temperature Température (°C)	-1°C/+7°C									
<b>Clase Climática</b> Climatic class Classe climatique (°C)	4 / 38°C									
<b>Tensión/Frecuencia</b> Electrical data Tension électrique	230V/1ph/50Hz									
<b>Controlador</b> Controller Régulateur	Digital									
<b>Material</b> Material Matériel (EXT/INT)	Aluminio anodizado / Anodized aluminium / Aluminium anodisé Inox AISI 304									
<b>Espesor</b> Thickness Épaisseur (mm)	70									
<b>Aislamiento</b> Isolation Isolation (mm)	40kg/m <sup>3</sup> / Free CFC's / Zero ODP-GWP									
<b>Capacidad</b> Capacity Capacité (L)	9,2	13,6	18,4	9,2	13,6	18,4	16,0	20,4	16,0	20,4
<b>Superficie exposición</b> Surface exhibition Surface d'exposition (m <sup>2</sup> )	0,23	0,34	0,46	0,23	0,34	0,46	0,40	0,51	0,40	0,51
<b>Bandejas GN</b> Trays GN Grilles GN	4	6	8	4	6	8	7	9	7	9
<b>Sistema de frío</b> Cooling System Système de froid	Ventilado / Ventilated / Ventilé									
<b>Desescarche</b> Defrost Dégivrage	Manual / Manual / Manuel									
<b>Expansión</b> Expansion Expansion	Capilar / Capillary / Capillaire									
<b>Potencia</b> Power Puissance (W)	129	131	133	133	136	140	131	133	131	133
<b>Potencia frig.</b> Cooling capacity Puissance Frig. (W A -10°C)	169									
<b>Consumo</b> Consumption Consommation (kWh/24h)	1,79	1,82	1,84	1,85	1,90	1,96	1,83	1,83	1,86	1,86
<b>Área refrigerada</b> Refrigerated area Zone réfrigérée (m <sup>2</sup> )	0,41	0,52	0,63	0,72	0,92	1,12	0,43	0,54	0,76	0,96
<b>Refrigerante</b> Refrigerant Gaz	R-600a									
<b>Opcional</b> Optional Options	-									

Serie / Series / Série **VET**

+Info: [www.infrico.com](http://www.infrico.com)

VET 8 P



VET 6 DP



**Expositor encastrable**  
Drop-in exhibitor  
Présentoir encastrable

VET 7 DP GR

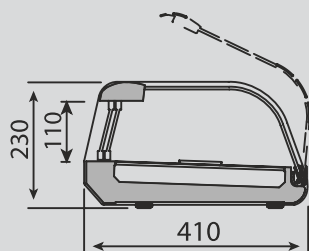



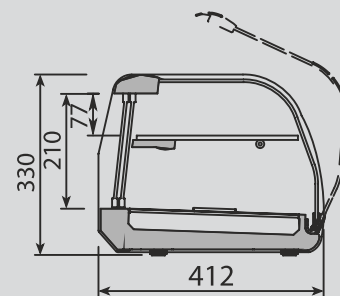



VET P



VET DP / DP GR



# Expositor sushi, pescado y marisco / Sushi, fish and seafood display case / Vitrine sushi, poisson et crustacés

MODELO MODELE MODÈLE						
	VSU 4 P	VSU 6 P	VSU 8 P	VSU 4 PR	VSU 6 PR	VSU 8 PR
<b>Precio</b> Price Prix						
<b>Medidas</b> Measures Mesures (mm)	1268 x 410 x 230 mm.	1620 x 410 x 230 mm.	1972 x 410 x 230 mm.	1268 x 410 x 230 mm.	1620 x 410 x 230 mm.	1972 x 410 x 230 mm.
<b>Temperatura</b> Temperature Température (°C)	-1°C/+7°C					
<b>Clase Climática</b> Climatic class Classe climatique (°C)	3 / 25°C					
<b>Tensión/Frecuencia</b> Electrical data Tension électrique	230V/1ph/50Hz					
<b>Controlador</b> Controller Régulateur	Digital					
<b>Material</b> Material Matériel (EXT/INT)	Aluminio anodizado / Anodized aluminium / Aluminium anodisé Inox AISI 304					
<b>Espesor</b> Thickness Épaisseur (mm)	70					
<b>Aislamiento</b> Isolation Isolation (mm)	40kg/m <sup>3</sup> / Free CFC's / Zero ODP-GWP					
<b>Capacidad</b> Capacity Capacité (L)	9,2	13,3	15,5	9,2	13,3	15,5
<b>Superficie exposición</b> Surface exhibition Surface d'exposition (m <sup>2</sup> )	0,23	0,34	0,46	0,23	0,34	0,46
<b>Nº puertas</b> Doors Nº de portes	2					
<b>Sistema de frío</b> Cooling System Système de froid	Ventilado / Ventilated / Ventilé					
<b>Desescarche</b> Defrost Dégivrage	Manual / Manual / Manuel					
<b>Expansión</b> Expansion Expansion	Capilar / Capillary / Capillaire					
<b>Potencia</b> Power Puissance (W)	225	227	228	225	227	228
<b>Potencia frig.</b> Cooling capacity Puissance Frig. (W A -10°C)	370					
<b>Consumo</b> Consumption Consommation (kWh/ 24h)	4,81	4,83	4,85	4,81	4,83	4,85
<b>Área refrigerada</b> Refrigerated area Zone réfrigérée (m <sup>2</sup> )	0,23	0,34	0,46	0,23	0,34	0,46
<b>Refrigerante</b> Refrigerant Gaz	R-290a					
<b>Opcional</b> Optional Options	-					

Serie / Series / Série **VSU**

+Info: [www.infrico.com](http://www.infrico.com)

VSU 8 P



VSU 8 PR



Desagüe en la parte inferior  
Bottom drain  
Drainage au fond

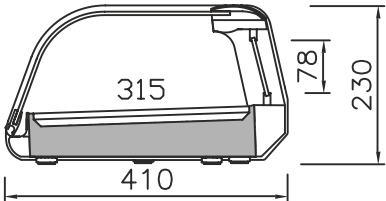

VSU P / PR

# Vitrina para pizza y sandwiches, cuba 1/4 / Refrigerated pizzas & sandwiches cases, 1/4 trays / Vitrine ingrédients pizzas & sandwiches 1/4

MODELO MODELE MODÈLE	CRISTAL / GLASS / VITRÉE				
	VIP 1330 1/4 C	VIP 1490 1/4 C	VIP 1740 1/4 C	VIP 1980 1/4 C	VIP 2300 1/4 C
Precio Price Prix					
Medidas Measures Mesures (mm)	1328 x 353 x 450 mm.	1493 x 353 x 450 mm.	1733 x 353 x 450 mm.	1976 x 353 x 450 mm.	2300 x 353 x 450 mm.
MODELO MODELE MODÈLE	TAPA / LID / COUVERCLE INOX				
	VIP 1330 1/4 T	VIP 1490 1/4 T	VIP 1740 1/4 T	VIP 1980 1/4 T	VIP 2300 1/4 T
Precio Price Prix					
Medidas Measures Mesures (mm)	1328 x 353 x 260 mm.	1493 x 353 x 260 mm.	1733 x 353 x 260 mm.	1976 x 353 x 260 mm.	2300 x 353 x 260 mm.
Temperatura Temperature Température (°C)	-1°C/+7°C				
Clase Climática Climatic class Classe climatique (°C)	4 / 38°C				
Tensión/Frecuencia Electrical data Tension électrique	230V/1ph/50Hz				
Controlador Controller Régulateur	Digital				
Material Material (EXT/INT) Matériel	Inox AISI 304				
Espesor Thickness Épaisseur (mm)	70				
Aislamiento Isolation Isolation (mm)	40kg/m <sup>3</sup> / Free CFC's / Zero ODP-GWP				
Capacidad Capacity Capacité (L)	32	37	48	57	70
Superficie exposición Surface exhibition Surface d'exposition (m <sup>2</sup> )	0,20	0,24	0,31	0,37	0,45
Compresor Compressor Compresseur (HP)	-				
Sistema de frío Cooling System Système de froid	Ventilado / Ventilated / Ventilé				
Desescarche Defrost Dégivrage	Manual / Manual / Manuel				
Expansión Expansion Expansion	Capilar / Capillary / Capillaire				
Potencia Power Puissance (W)	125				
Potencia frig. Cooling capacity Puissance Frig. (W A -10°C)	169				
Consumo Consumption Consommation (kWh/24h)	1,33	1,36	1,39	1,41	1,44
Refrigerante Refrigerant Gaz	R-600a				
Opcional Optional Options	Puertas correderas traseras MOD. C / Rear sliding doors MOD. C / Portes coulissantes arrière MOD. C				
	KPUVIP134C	KPUVIP144C	KPUVIP174C	KPUVIP194C	KPUVIP234C

Serie / Series / Série **VIP**

+Info: [www.infrico.com](http://www.infrico.com)

VIP 2300 1/4 T  
TAPA / LID / COUVERCLE INOX



VIP 2300 1/4 C  
CRISTAL / GLASS / VITRÉE



Puertas correderas traseras  
Rear sliding doors  
Portes coulissantes arrière

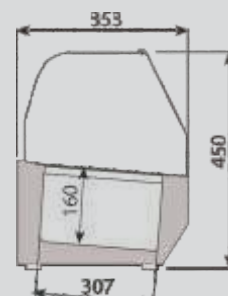

VIP 1/4 C  
CRISTAL / GLASS / VITRÉE

VIP 1330 1/4  
{501X13} = 1 {501X16} = 3



VIP 1490 1/4  
{501X16} = 6



VIP 1740 1/4  
{501X13} = 1 {501X16} = 5

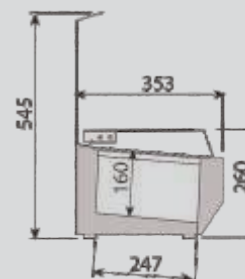

VIP 1/4 T  
TAPA / LID / COUVERCLE INOX











VIP 1980 1/4  
{501X13} = 1



VIP 2300 1/4  
{501X13} = 1 {501X16} = 9



# Vitrina para pizza y sandwiches, cuba 1/3 / Refrigerated pizza & sandwiches cases, 1/3 trays / Vitrine ingrédients pizza & sandwiches 1/3

MODELO MODELE MODÈLE	CRISTAL / GLASS / VITRÉE									
	 VIP 1330 1/3 C	 VIP 1490 1/3 C	 VIP 1740 1/3 C	 VIP 1980 1/3 C	 VIP 2300 1/3 C					
Precio Price Prix										
Medidas Measures Mesures (mm)	1328 x 413 x 450 mm.	1493 x 413 x 450 mm.	1733 x 413 x 450 mm.	1976 x 413 x 450 mm.	2300 x 413 x 450 mm.					
MODELO MODELE MODÈLE	TAPA / LID / COUVERCLE INOX									
	 VIP 1330 1/3 T	 VIP 1490 1/3 T	 VIP 1740 1/3 T	 VIP 1980 1/3 T	 VIP 2300 1/3 T					
Precio Price Prix										
Medidas Measures Mesures (mm)	1328 x 413 x 260 mm.	1493 x 413 x 260 mm.	1733 x 413 x 260 mm.	1976 x 413 x 260 mm.	2300 x 413 x 260 mm.					
Temperatura Temperature Température (°C)	-1°C/+7°C									
Clase Climática Climatic class Classe climatique (°C)	4 / 38°C									
Tensión/Frecuencia Electrical data Tension électrique	230V/1ph/50Hz									
Controlador Controller Régulateur	Digital									
Material Material (EXT/INT) Matériel	Inox AISI 304									
Espesor Thickness Épaisseur (mm)	70									
Aislamiento Isolation Isolation (mm)	40kg/m <sup>3</sup> / Free CFC's / Zero ODP-GWP									
Capacidad Capacity Capacité (L)	CRISTAL / GLASS / VITRÉE TAPA / LID / COUVERCLE	41 32	CRISTAL / GLASS / VITRÉE TAPA / LID / COUVERCLE	50 37	CRISTAL / GLASS / VITRÉE TAPA / LID / COUVERCLE	64 48	CRISTAL / GLASS / VITRÉE TAPA / LID / COUVERCLE	78 57	CRISTAL / GLASS / VITRÉE TAPA / LID / COUVERCLE	97 70
Superficie exposición Surface exhibition Surface d'exposition (m <sup>2</sup> )	CRISTAL / GLASS / VITRÉE TAPA / LID / COUVERCLE	0,26 0,20	CRISTAL / GLASS / VITRÉE TAPA / LID / COUVERCLE	0,31 0,24	CRISTAL / GLASS / VITRÉE TAPA / LID / COUVERCLE	0,39 0,31	CRISTAL / GLASS / VITRÉE TAPA / LID / COUVERCLE	0,46 0,37	CRISTAL / GLASS / VITRÉE TAPA / LID / COUVERCLE	0,57 0,45
Compresor Compressor Compresseur (HP)	-									
Sistema de frío Cooling System Système de froid	Ventilado / Ventilated / Ventilé									
Desescarche Defrost Dégivrage	Manual / Manual / Manuel									
Expansión Expansion Expansion	Capilar / Capillary / Capillaire									
Potencia Power Puissance (W)	125									
Potencia frig. Cooling capacity Puissance Frig. (W A -10°C)	169									
Consumo Consumption Consommation (kWh/ 24h)	1,35	1,37	1,40	1,43	1,45					
Refrigerante Refrigerant Gaz	R-600a									
Opcional Optional Options	Puertas correderas traseras MOD. C / Rear sliding doors MOD. C / Portes coulissantes arrière MOD. C									
	KPUVIP133C	KPUVIP143C	KPUVIP173C	KPUVIP193C	KPUVIP233C					



Serie / Series / Série **VIP**

+Info: [www.infrico.com](http://www.infrico.com)

VIP 2300 1/3 T  
TAPA / LID / COUVERCLE INOX



VIP 2300 1/3 C  
CRISTAL / GLASS / VITRÉE



Opcion/Option/Option  
Puertas correderas traseras  
Rear sliding doors  
Portes coulissantes arrière

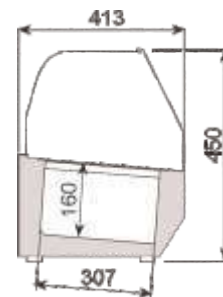

VIP 1/3 C  
CRISTAL / GLASS / VITRÉE

VIP 1330 1/3  
(501X13) = 1 (501X11) = 3



VIP 1490 1/3  
(501X13) = 1 (501X11) = 4



VIP 1740 1/3  
(501X13) = 1 (501X11) = 5



VIP 1980 1/3  
(501X11) = 8





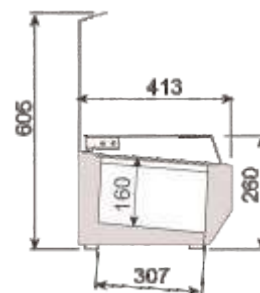



VIP 2300 1/3  
(501X11) = 10



VIP 1/3 T  
TAPA / LID / COUVERCLE INOX

**Vitrina mural sobre mostrador /  
Wall display counter case /  
Vitrine murale**

**Vitrina cerrada refrigerada /  
3/4 vision counter case /  
Vitrine réfrigérée comptoir panoramique**

	VMS			VC	
MODELO MODELE MODÈLE					
	VMS 1000 I	VMS 1350 I	VMS 1500 I	VC 1400	VC 2010
Precio Price Prix					
Medidas Measures [mm] Mesures	1003 x 580 x 1110 mm.	1354 x 580 x 1110 mm.	1504 x 580 x 1110 mm.	1384 x 740 x 1060 mm.	2011 x 740 x 1060 mm.
Temperatura Temperature [°C] Température	<b>3°C/+6°C</b>				
Clase Climática Climatic class [°C] Classe climatique	4 / 38°C			4 / 38°C	
Tensión/Frecuencia Electrical data Tension électrique	230V/1ph/50Hz				
Controlador Controller Régulateur	Digital				
Material Material [EXT/INT] Matériel	Inox AISI 304				
Espesor Thickness [mm] Épaisseur	70				
Aislamiento Isolation [mm] Isolation	40kg/m <sup>3</sup> / Free CFC's / Zero ODP-GWP				
Capacidad Capacity [L] Capacité	220	300	340	470	710
Superficie exposición Surface exhibition [m <sup>2</sup> ] Surface d'exposition	0,36	0,50	0,56		
Nº puertas / Estantes Doors / Shelving Nº de portes / Étagères	2 / 2			2 / 2	3 / 2
Sistema de frío Cooling System Système de froid	Ventilado / Ventilated / Ventilé			Ventilado / Ventilated / Ventilé	
Desescarche Defrost Dégivrage	Automático / Automatic / Automatique			Parada de compresor / Compressor off / Arrêt du compresseur	
Expansión Expansion Expansion	Capilar / Capillary / Capillaire			Capilar / Capillary / Capillaire	
Potencia Power [W] Puissance	239	246	249	551	557
Potencia frig. Cooling capacity [W A -10°C] Puissance Frig.				687	
Consumo Consumption [kWh/ 24h] Consommation	3,4	3,54	3,6	8,6	9,7
Clase energética Energy class Classe Énerg.					
Refrigerante Refrigerant Gaz	<b>R-290</b>				
Opcional Optional Options				Puerta de cristal Glass door [unit] Porte vitrée [unité] (Dcha.-Right-Droite) KPUIDVCCR (Izq.-Left-Gauche) KPUIVCCR  Estante de cristal Glass shelf [unit] Étagère vitrée [unité] [604V156]  Cerradura puerta ciega Solid door lock Serrure porte inox [506X120; 506X121]  Cerradura puerta cristal Glass door lock Serrure porte vitrée [506X60]  Opción color NEGRO Option BLACK color Couleur NOIR en option  VC 1400 B VC 2010 B	

Serie / Series / Série **VMS / VC**

+Info: [www.infrico.com](http://www.infrico.com)

VC 2010 B



VMS 1000 I



VC 1400

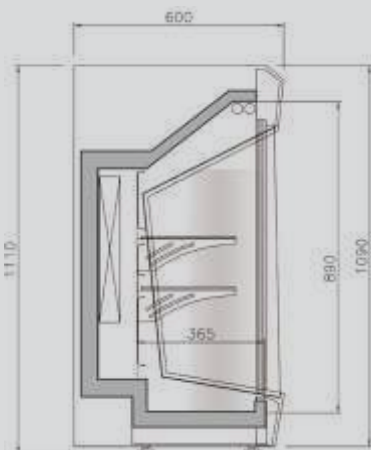

**Puertas traseras /  
Back doors /  
Portes arrières**



VC 2100

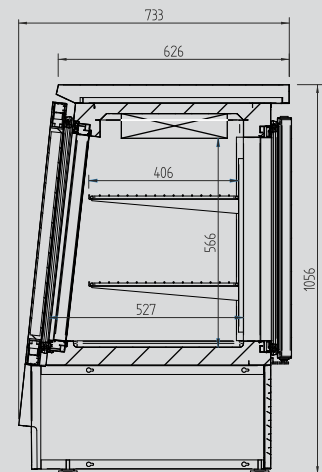

**Vitrina expositora carro para pescado /**  
**Fish display case /**  
**Vitrine réfrigérée pour poisson sur roulettes**

**Vitrina expositora para pescado /**  
**Fish display case /**  
**Vitrine réfrigérée pour poisson**



MODELO MODELE MODÈLE	VRP 13	VML 12	VML 15	VML 18
Precio Price Prix				
Medidas Measures Mesures (mm)	1320 x 850 x 1275 mm.	1330 x 900 x 1335 mm.	1642 x 900 x 1335 mm.	1955 x 900 x 1335 mm.
Temperatura Temperature Température (°C)	-1°C/+1°C			
Clase Climática Climatic class Classe climatique (°C)	4 / 38°C			
Tensión/Frecuencia Electrical data Tension électrique	230V/1ph/50Hz			
Controlador Controller Régulateur	Digital			
Material Material Matériel (EXT/INT)	Inox AISI 304			
Espesor Thickness Épaisseur (mm)	70			
Aislamiento Isolation Isolation (mm)	40kg/m <sup>3</sup> / Free CFC's / Zero ODP-GWP			
Capacidad Capacity Capacité (L)	115	115	237	360
Superficie exposición Surface exhibition Surface d'exposition (m <sup>2</sup> )	0,75	0,79	0,99	1,19
Compresor Compressor Compresseur (HP)	1/4	1/3	1/2	7/8
Sistema de frío Cooling System Système de froid	Ventilado / Ventilated / Ventilé			
Desescarche Defrost Dégivrage	Manual / Manual / Manuel			
Expansión Expansion Expansion	Capilar / Capillary / Capillaire			
Potencia Power Puissance (W)	475	410	410	520
Potencia frig. Cooling capacity Puissance Frig. (W A -10°C)	-			
Consumo Consumption Consommation (kWh/ 24h)	6,7	8,7	12,5	8,9
Clase energética Energy class Classe Énerg.				
Refrigerante Refrigerant Gaz	R-290a			
Opcional Optional Options		Iluminación LED frontal Frontal LED lighting Éclairage LED frontale ILUDECVMBC12	Iluminación LED frontal Frontal LED lighting Éclairage LED frontale ILUDECVMBC15	Iluminación LED frontal Frontal LED lighting Éclairage LED frontale ILUDECVMBC18

Serie / Series / Série **VRP / VML MÁLAGA**

+Info: [www.infrico.com](http://www.infrico.com)

VRP 13



VML 18

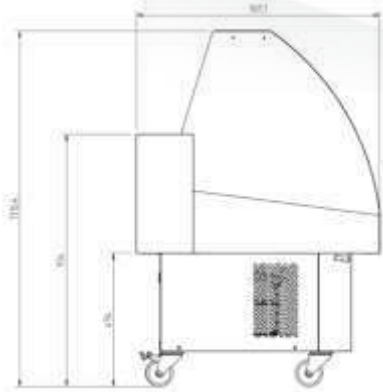



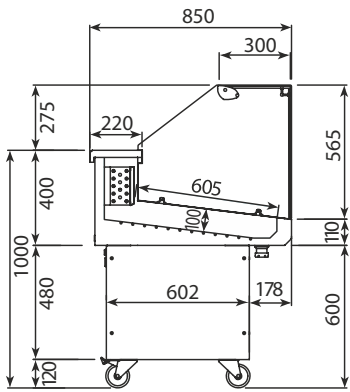







VML



VRP

Los datos técnicos están sujetos a posibles variaciones que serán actualizadas periódicamente en las fichas técnicas del producto, disponibles en la web /  
The technical data are subject to possible variations that will be updated periodically in the technical data sheets of the product, which are available on the website /  
Les données techniques peuvent varier et seront actualisées dans les fiches techniques du produit, disponibles sur le site web.

# Mueble caja mostrador / Counter case / Meuble caisse

MODELO MODELE MODÈLE					
<b>Precio</b> Price Prix					
<b>Medidas</b> Measures Mesures (mm)	944 x 979 x 1323 mm.	1256 x 979 x 1323 mm.	1568 x 979 x 1323 mm.	1881 x 979 x 1323 mm.	2506 x 979 x 1323 mm.
MODELO MODELE MODÈLE					
<b>Precio</b> Price Prix					
<b>Medidas</b> Measures Mesures (mm)	944 x 979 x 1323 mm.	1256 x 979 x 1323 mm.	1568 x 979 x 1323 mm.	1881 x 979 x 1323 mm.	2506 x 979 x 1323 mm.
<b>Temperatura</b> Temperature Température (°C)	3°C/+6°C				
<b>Clase Climática</b> Climatic class Classe climatique (°C)	4 / 38°C				
<b>Tensión/Frecuencia</b> Electrical data Tension électrique	230V/1ph/50Hz				
<b>Controlador</b> Controller Régulateur	Digital				
<b>Material</b> Material (EXT/INT) Matériel	Ext: Acero galvanizado / Galvanized steel / Acier galvanisée Int: PVC				
<b>Espesor</b> Thickness Épaisseur (mm)	50				
<b>Aislamiento</b> Isolation Isolation (mm)	40kg/m <sup>3</sup> / Free CFC's / Zero ODP-GWP				
<b>Capacidad</b> Capacity Capacité (L)	200	262	324	387	512
<b>Superficie exposición</b> Surface exhibition Surface d'exposition (m <sup>2</sup> )	0,50	0,70	0,9	1,0	1,4
<b>Nº puertas / Estantes</b> Doors / Shelving N° de portes / Étagères	1 / 1	2 / 1	2 / 1	3 / 1	4 / 1
<b>Sistema de frío</b> Cooling System Système de froid	Estático / Static / Statique				
<b>Desescarche</b> Defrost Dégivrage	Automático / Automatic / Automatique				
<b>Expansión</b> Expansion Expansion	Capilar / Capillary / Capillaire				
<b>Potencia</b> Power Puissance (W)	280	460	460	650	650
<b>Potencia frig.</b> Cooling capacity Puissance Frig. (W A -10°C)	370	687	687	951	951
<b>Consumo</b> Consumption Consummation (kWh/ 24h)	-				
<b>Clase energética</b> Energy class Classe Énerg.	-				
<b>Refrigerante</b> Refrigerant Gaz	R-290				
<b>Opcional</b> Optional Options	115V/1ph/60Hz 230V/1ph/60Hz				

Serie / Series / Série **JULIET**

+Info: [www.infrico.com](http://www.infrico.com)

**Cristal panorámico sin marco**  
Panoramic frameless glass  
Vitrage panoramique sans cadre

VJU 18 P



**Laterales en acero**  
Sides steel  
Joues en acier

**Costados / Sides / Joues**

**Incluidos / Includes / Inclus**

**Ext. Estándar / Standar / Standard**

Blanco/White/ Blanc	Ral 1001	Ral 1018
Ral 3003	Ral 3020	Ral 2003
Ral 5015	Ral 5017	Ral 5011
Ral 6002	Ral 6018	Ral 6019
Ral 7035	Ral 7037	Ral 7042
Ral 7016	Ral 9006	Negro/Black/ Noir











**Colores fuera de carta /  
Colors outside of letter /  
Couleurs spéciales, hors palette**

RAL		NO RAL	
Epoxi	Líquida/ Liquid/ Liquide	Epoxi	Líquida/ Liquid/ Liquide
<b>817 €</b>	<b>508 €</b>	Consultar / Consulter / Consulter	
[x unidad/x unit/x unité]			
+10 días laborables / +10 work days / +10 jours ouvrés		Consultar / Consulter / Consulter	

VJU 12 C



# Vitrina expositora frío ventilado / Refrigerated whit storage display case / Vitrine de présentation non canalisable

		CRISTAL CURVO / CURVED GLASS / VITRE BOMBÉE				
MODELO MODELE MODÈLE						
		VMB 9 RU/RIU	VMB 12 RU/RIU	VMB 15 RU/RIU	VMB 18 RU/RIU	VMB 25 RU/RIU
Precio Price Prix	RU RIU					
Medidas Measures Mesures	(mm)	998 x 953 x 1300 mm.	1310 x 953 x 1300 mm.	1622 x 953 x 1300 mm.	1935 x 953 x 1300 mm.	2560 x 953 x 1300 mm.
		CRISTAL RECTO / FLAT GLASS / VITRE DROITE				
MODELO MODELE MODÈLE						
		VMB 9 RUP/RIUP	VMB 12 RUP/RIUP	VMB 15 RUP/RIUP	VMB 18 RUP/RIUP	VMB 25 RUP/RIUP
Precio Price Prix	RUP RIUP					
Medidas Measures Mesures	(mm)	998 x 953 x 1315 mm.	1310 x 953 x 1315 mm.	1622 x 953 x 1315 mm.	1935 x 953 x 1315 mm.	2560 x 953 x 1315 mm.
Temperatura Temperature Température	(°C)	0°C/+6°C				
Clase Climática Climatic class Classe climatique	(°C)	4 / 38°C				
Tensión/Frecuencia Electrical data Tension électrique		230V/1ph/50Hz				
Controlador Controller Régulateur		Digital				
Material Material Matériel	(EXT/INT)	Acero plastificado / Plastic-coated steel / Acier plastifié Inox AISI 304				
Costados Sides Joues	(mm)	30 + 30				
Aislamiento Isolation Isolation	(mm)	40kg/m <sup>3</sup> / Free CFC's / Zero ODP-GWP				
Capacidad Capacity Capacité	(L)	144	191	239	287	382
Superficie exposición Surface exhibition Surface d'exposition	(m <sup>2</sup> )	0,66	1,08	1,35	1,63	2,18
Compresor Compressor Compresseur	(HP)	1/3	3/8	5/8	3/4	1
Sistema de frío Cooling System Système de froid		Ventilado / Ventilated / Ventilé				
Desescarche Defrost Dégivrage		Automático / Automatic / Automatique				
Expansión Expansion Expansion		Ventilado / Ventilated / Ventilé				
Potencia Power Puissance	(W)	380	384	523	573	670
Potencia frig. Cooling capacity Puissance Frig.	(W A -10°C)	-				
Consumo Consumption Consommation	(kWh/ 24h)	5,9	6,1	7,6	8,3	9,7
Refrigerante Refrigerant Gaz		R-290a				
Opcional Optional Options		Puertas correderas traseras / Rear sliding doors / Portes coulissantes arrière VMB		VMB P	Luz LED deco. frontal / Frontal deco. LED lighting / Éclair. LED deco. frontale	
		PUEVMB9CT	PUEVMB12CT	PUEVMB15CT	PUEVMB18CT	PUEVMB25CT
		PUEVMB9CTCP	PUEVMB12CTCP	PUEVMB15CTCP	PUEVMB18CTCP	PUEVMB25CTCP
		ILUDECVMBC9		ILUDECVMBC12	ILUDECVMBC15	ILUDECVMBC18
		ILUDECVMBC9		ILUDECVMBC12	ILUDECVMBC15	ILUDECVMBC18
		Luz LED estante / LED lighting shelf / Éclairage LED étagère				
		ILUESTVMBC9		ILUESTVMBC12	ILUESTVMBC15	ILUESTVMBC18
		ILUESTVMBC9		ILUESTVMBC12	ILUESTVMBC15	ILUESTVMBC18



Serie / Series / Série **MARBELLA**

+Info: [www.infrico.com](http://www.infrico.com)

VMB 15 RU



**Ext. Estándar / Standar / Standard**

Blanco/White/ Blanc	Ral 1001	Ral 1018
Ral 3003	Ral 3020	Ral 2003
Ral 5015	Ral 5017	Ral 5011
Ral 6002	Ral 6018	Ral 6019
Ral 7035	Ral 7037	Ral 7042
Ral 7016	Ral 9006	Negro/Black/ Noir

**Colores fuera de carta /  
Colors outside of letter /  
Couleurs spéciales, hors palette**

RAL		NO RAL	
Epoxi	Líquida/ Liquid/ Liquide	Epoxi	Líquida/ Liquid/ Liquide
<b>817 €</b>	<b>508 €</b>	Consultar / Consultar / Consulter	
[x unidad/x unit/x unité]			
+10 días laborables / +10 work days / +10 jours ouvrés		Consultar / Consultar / Consulter	

VMB 25 RUP

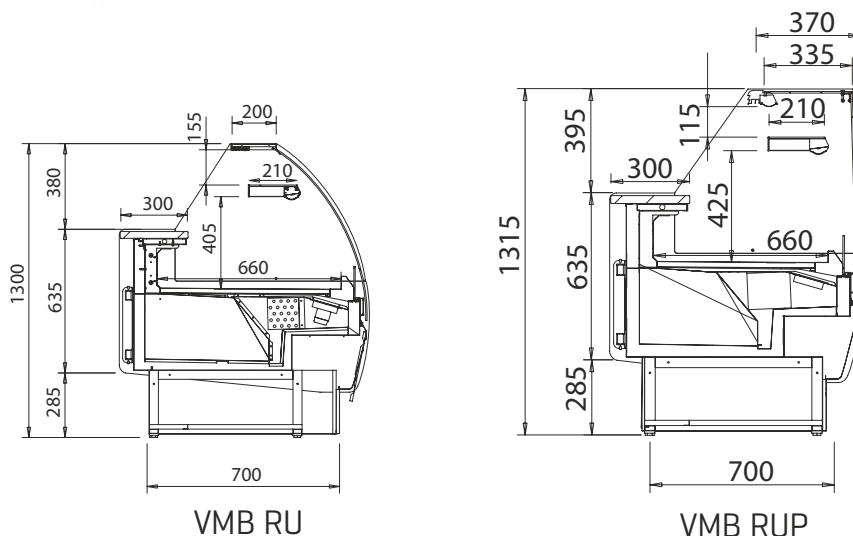

VMB RU

VMB RUP

# Vitrina expositora frío ventilado con reserva / Refrigerated whit storage display case / Vitrine de présentation avec réserve non canalisable



MODELO  
MODELE  
MODÈLE

VMC 9 RU/RIU

VMC 12 RU/RIU

VMC 15 RU/RIU

VMC 18 RU/RIU

VMC 25 RU/RIU

Precio Price Prix	RU					
	RIU					
Medidas Measures Mesures	[mm]	998 x 1103 x 1300 mm.	1310 x 1103 x 1300 mm.	1622 x 1103 x 1300 mm.	1935 x 1103 x 1300 mm.	2560 x 1103 x 1300 mm.
Temperatura Temperature Température	[°C]	0°C/+6°C				
Clase Climática Climatic class Classe climatique	[°C]	4 / 38°C				
Tensión/Frecuencia Electrical data Tension électrique		230V/1ph/50Hz				
Controlador Controller Régulateur		Digital				
Material Material Matériel	[EXT/INT]	Acero plastificado / Plastic-coated steel / Acier plastifié Inox AISI 304				
Costados Sides Joues	[mm]	30 + 30				
Aislamiento Isolation Isolation	[mm]	40kg/m <sup>3</sup> / Free CFC's / Zero ODP-GWP				
Capacidad Capacity Capacité	[L]	205	274	342	411	548
Superficie exposición Surface exhibition Surface d'exposition	[m <sup>2</sup> ]	0,82	1,09	1,36	1,63	2,18
Compresor Compressor Compresseur	[HP]	1/3	3/8	5/8	3/4	1
Sistema de frío Cooling System Système de froid		Ventilado / Ventilated / Ventilé				
Desescarche Defrost Dégivrage		Automático / Automatic / Automatique				
Expansión Expansion Expansion		Ventilado / Ventilated / Ventilé				
Potencia Power Puissance	[W]	380	384	523	573	670
Potencia frig. Cooling capacity Puissance Frig.	[W A -10°C]			-		
Consumo Consumption Consommation	[kWh/ 24h]	5,9	6,1	7,6	8,3	9,7
Clase energética Energy class Classe Énerg.		-				
Refrigerante Refrigerant Gaz		R-290a				
Opcional Optional Options		<b>Puertas correderas traseras / Rear sliding doors / Portes coulissantes arrière</b> PUEVMC9CT PUEVMC12CT PUEVMC15CT PUEVMC18CT PUEVMC25CT		<b>Luz LED deco. frontal / Frontal deco. LED lighting / Éclair. LED deco. frontale</b> ILUDECVMBC9 ILUDECVMBC12 ILUDECVMBC15  <b>Luz LED estante / LED lighting shelf / Éclairage LED étagère</b> ILUESTVMBC9 ILUESTVMBC12 ILUESTVMBC15  ILUDECVMBC18 ILUDECVMBC25  ILUESTVMBC18 ILUESTVMBC25		

Serie / Series / Série **MALLORCA**

+Info: [www.infrico.com](http://www.infrico.com)

VMC 18 RU



VMC 12 RU



**Ext. Estándar / Standar / Standard**

Blanco/White/Blanc	Ral 1001	Ral 1018
Ral 3003	Ral 3020	Ral 2003
Ral 5015	Ral 5017	Ral 5011
Ral 6002	Ral 6018	Ral 6019
Ral 7035	Ral 7037	Ral 7042
Ral 7016	Ral 9006	Negro/Black/Noir

**Colores fuera de carta / Colors outside of letter / Couleurs spéciales, hors palette**

RAL		NO RAL	
Epoxi	Líquida/ Liquid/ Liquide	Epoxi	Líquida/ Liquid/ Liquide
<b>817 €</b>	<b>508 €</b>	Consultar / Consultar / Consulter	
[x unidad/x unit/x unité]			
+10 días laborables / +10 work days / +10 jours ouvrés		Consultar / Consultar / Consulter	

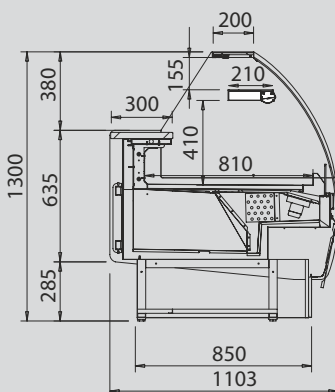

VMC RU

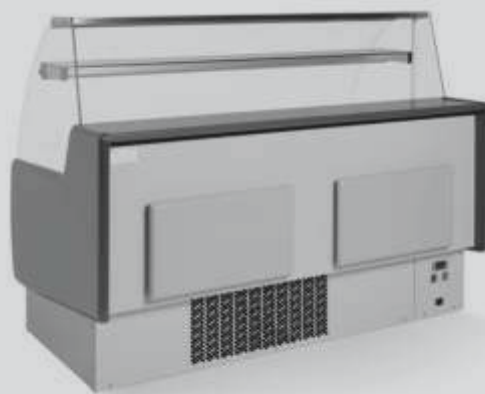

**Mueble caja mostrador /  
Counter case /  
Meuble caisse**

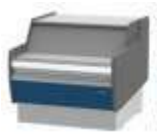

**VMB 9 C**

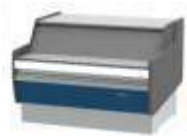

**VMB 12 M**

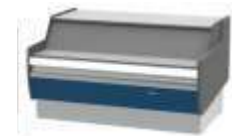

**VMB 15 M**

MODELO MODELE MODÈLE	VMB 9 C	VMB 12 M	VMB 15 M
<b>Precio</b> Price Prix			
<b>Medidas</b> Measures Mesures [mm]	998 x 953 x 920 mm.	1310 x 953 x 920 mm.	1622 x 953 x 920 mm.
<b>Temperatura</b> Temperature Température [°C]	-		
<b>Clase Climática</b> Climatic class Classe climatique [°C]	-		
<b>Tensión/Frecuencia</b> Electrical data Tension électrique	230V/1ph/50Hz		
<b>Superficie exposición</b> Surface exhibition Surface d'exposition [m <sup>2</sup> ]	0,62	0,83	1,03
<b>Potencia</b> Power Puissance [W]	-		

**Mueble caja mostrador /  
Counter case /  
Meuble caisse**

**Serie / Series / Série MALLORCA**



**VMC 9 C**



**VMC 12 M**

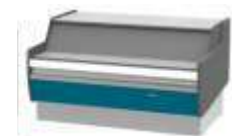

**VMC 15 M**

MODELO MODELE MODÈLE	VMC 9 C	VMC 12 M	VMC 15 M
<b>Precio</b> Price Prix			
<b>Medidas</b> Measures Mesures [mm]	998 x 1103 x 920 mm.	1310 x 1103 x 920 mm.	1622 x 1103 x 920 mm.
<b>Temperatura</b> Temperature Température [°C]	-		
<b>Clase Climática</b> Climatic class Classe climatique [°C]	-		
<b>Tensión/Frecuencia</b> Electrical data Tension électrique	230V/1ph/50Hz		
<b>Superficie exposición</b> Surface exhibition Surface d'exposition [m <sup>2</sup> ]	0,55	0,74	0,94
<b>Potencia</b> Power Puissance [W]	-		



Serie / Series / Série **MARBELLA**

+Info: [www.infrico.com](http://www.infrico.com)

VMB 9 C



VMB 12 C



VMC 12 M



VMC 15 M

**Ext. Estándar / Standar / Standard**

Blanco/White/ Blanc	Ral 1001	Ral 1018
Ral 3003	Ral 3020	Ral 2003
Ral 5015	Ral 5017	Ral 5011
Ral 6002	Ral 6018	Ral 6019
Ral 7035	Ral 7037	Ral 7042
Ral 7016	Ral 9006	Negro/Black/ Noir

**Colores fuera de carta /  
Colors outside of letter /  
Couleurs spéciales, hors palette**

RAL		NO RAL	
Epoxi	Líquida/ Liquid/ Liquide	Epoxi	Líquida/ Liquid/ Liquide
<b>817 €</b>	<b>508 €</b>	Consultar / Consultar / Consulter	
[x unidad/x unit/x unité]			
+10 días laborables / +10 work days / +10 jours ouvrés		Consultar / Consultar / Consulter	

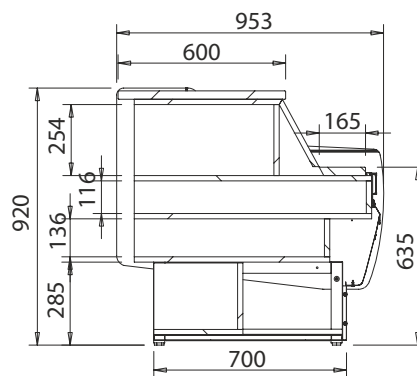

VMB M

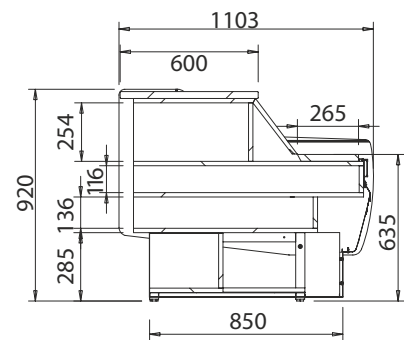

VMC M



+Info: [www.infrico.com](http://www.infrico.com)



# Super market







# Waterin

Sistema Waterloop R290 de Infrico

270-273

Serie / Series / Série

## VMD Madrid



VMD R/S  
VMD R/S Ángulos/Angles/Angles  
VMD C / M \_\_\_\_\_ 274-281

Serie / Series / Série

## VBC Barcelona



VBC R/S  
VBC R/S Ángulos/Angles/Angles  
VBC C / M / MHD  
VBC R/S CP  
VBC R/S CP Ángulos/Angles/Angles  
VBC CP / MP / MHDP  
VBC S CB \_\_\_\_\_ 282-303

Serie / Series / Série

## VEX Experience

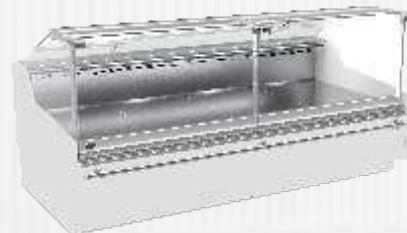

VEX CP  
VEX  
VEX CB  
VEX Ángulos/Angles/Angles  
VEX CA / CP HT \_\_\_\_\_ 304-317

Serie / Series / Série

## VEE California



VEE  
VEE CA  
VEE HT  
VEE GC  
VEE S  
VEE AAM \_\_\_\_\_ 318-325

Serie / Series / Série

## Visión



SVS  
VVS  
VCD  
VVL \_\_\_\_\_ 326-327

Serie / Series / Série

## GD/COMBI



GD P  
AS25U \_\_\_\_\_ 328-331



# 9. Supermarket

Estructura de cristales de alta transparencia, rectos o curvos según modelo.

High transparency glass structure, flat or curved depending on the model.

Structure en verre à haute transparence, droite ou bombée selon le modèle.

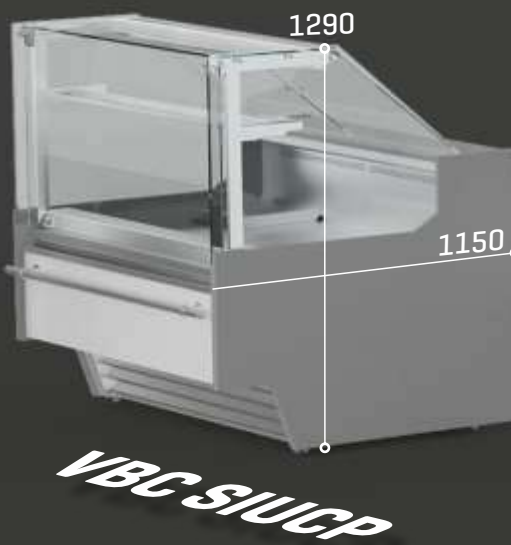
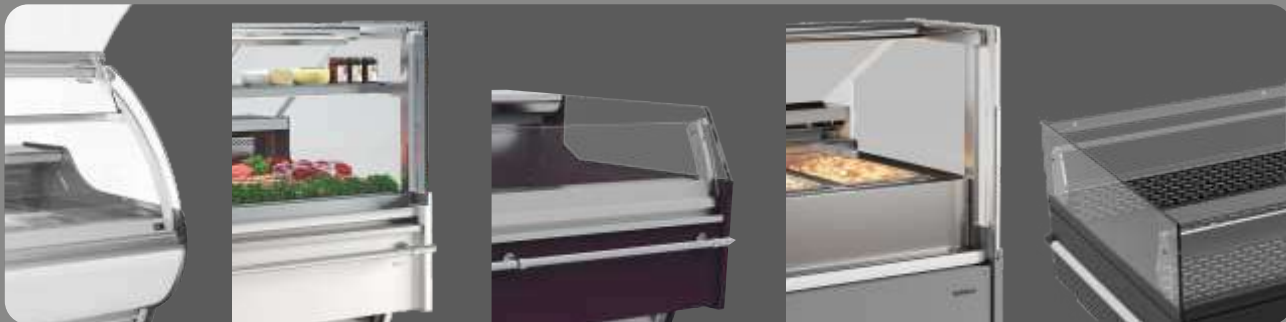

## Iluminación / Lighting / Éclairage

Incorporación de iluminación LED, llegando a reducir el consumo energético entre un 80% y 90%, respecto a una bombilla tradicional.

LED lighting incorporated, reducing energetic consumption between 80% and 90% respect to a traditional lighth bulb.

Éclairage LED, réduisant la consommation énergétique entre 80% et 90%, par rapport à une ampoule traditionnelle.



Equipos con posibilidad de grupo remoto y grupo incorporado.

Devices with the possibility of remote group and integrated group.

Équipement avec la possibilité de groupe à distance et de groupe incorporé.



Máxima visibilidad de producto expuesto.

Maximum visibility of displayed product.

Visibilité maximale du produit exposé.



Amplia gama de opciones y posibilidades de personalización para exponer todo tipo de productos refrigerados sin envasar: carne, charcutería y delicatessen.

Wide range of options and customisation possibilities for displaying all types of unpackaged refrigerated products: meat, deli and delicatessen.

Nombreuses options et possibilités de personnalisation pour présenter tous les types de produits réfrigérés non emballés : viande, charcuterie et delicatessen.



# Waterin

Sistema Waterloop R290 de Infrico

hasta  
**-25%**

Sistema eficiente, hasta el 25% de ahorro de energía.  
Efficient system with up to 25% energy saving.  
Système efficace avec jusqu'à 25 % d'économies d'énergie.

**-75%**

75% reducción carga refrigerante.  
75% refrigerant charge reduction.  
Réduction de 75 % de la charge de réfrigérant.

**0€**

Refrigerantes naturales SIN TASA.  
Natural refrigerants WITHOUT CHARGE.  
Réfrigérateurs naturels SANS TÂCHE.



Mínima carga refrigerante, aprox. 0.1kg/kw.  
Minimum refrigerant load, aprox. 0.1kg/kw.  
Charge minimale de réfrigérant, avec environ 0,1 Kg/kw de réfrigération.

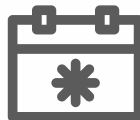

Flexibilidad de implantación.  
Flexibility of implementation.  
Flexibilité de mise en oeuvre.



Posibilidad de recuperación de calor en la instalación.  
Possibility of heat recovery in the installation.  
Possibilité de récupération de chaleur dans l'installation.



Condensadores sin mantenimiento.  
Maintenance-free condensers.  
Condensateurs de maintenance.



Posible eliminación de la sala de máquinas.  
Possible elimination of the machine room.  
Élimination possible, dans de nombreux cas, de la salle des machines.



Eliminación de riesgos típicos de inst. centralizadas.  
Elimination of the typical risks of central installations.  
Élimination des risques typiques des installations centralisées.



Menor riesgo de fugas.  
Reduced risk of leakage.  
Moins de risques de fuites.



El ahorro energético y el cuidado del medio ambiente son dos factores claves que han impulsado la iniciativa Waterin.

#### **¿Qué es Waterin?**

Waterin son muebles de refrigeración comercial para la conservación de productos refrigerados y congelados, con unidades individuales R290 y sistema de condensación por agua.

#### **¿Dónde podemos instalar este sistema?**

Este sistema es óptimo para instalaciones que cumplan los siguientes condicionantes:

- Sala de ventas de hasta 1400m<sup>2</sup> con aproximadamente hasta 40kW frigoríficos.
- Temperatura de trabajo exterior (DryCooler) máxima de 48°C.

#### **¿Este nuevo sistema requiere un proyecto de instalación?**

El sistema Waterin no requiere instalación frigorífica porque son muebles con la unidad ya instalada y cargada desde fábrica, aunque su implantación requiere un cálculo de instalación para el dimensionado de las tuberías de agua, el DryCooler, el sistema hidráulico necesarios y su ubicación, etc.

#### **Beneficios del sistema Waterin**

Waterin por ser un sistema ecológico y de condensación por agua ofrece múltiples beneficios en la refrigeración comercial. Mayor eficiencia energética, menor impacto ambiental y mejor control de temperatura son sólo algunas de sus ventajas.



Saving energy and respect for the environment are two key factors that have driven the Waterin initiative.

#### **What's Waterin?**

Waterin are commercial refrigeration display cases for the preservation of refrigerated and frozen products, with individual R290 units and water condensation system.

#### **Where do we install this system?**

This system is ideal for installations that meet the following conditions:

- Supermarkets up to 1400m<sup>2</sup> with approximately up to 40kW of refrigeration capacity.
- Outdoor working temperature (DryCooler) max. 48°C.

#### **Is an installation project required?**

The Waterin system doesn't require refrigeration installation because it's display cases with the unit already installed and loaded from the factory, although its implementation requires an installation calculation for the dimensioning of the water pipes, the DryCooler, the necessary hydraulic system and its location, etc.

#### **Benefits of Waterin**

Waterin is an environmentally friendly, water condensing system that offers multiple benefits in commercial refrigeration. Greater energy efficiency, lower environmental impact and better temperature control are just some of its advantages.



Les économies d'énergie et le respect de l'environnement sont deux facteurs qui ont motivé l'initiative Waterin.

#### **Qu'est-ce que Waterin?**

Waterin est une armoire de réfrigération commerciale pour les températures positives et négatives de stockage des produits, avec des unités R290 individuelles et un système de condensation à l'eau.

#### **Où peut-on installer ce système?**

Ce système est optimal pour les installations qui répondent aux conditions suivantes :

- Salle de vente jusqu'à 1400 m<sup>2</sup> avec environ jusqu'à 40kW d'unités de réfrigération
- Température extérieure de travail (DryCooler) maximale de 48°C.

#### **Ce nouveau système nécessite-t-il un projet d'installation?**

Le système Waterin ne nécessite pas d'installation frigorifique car il s'agit d'un meuble avec l'unité déjà installée et chargée en usine, bien que sa mise en œuvre dans la salle de vente nécessite un calcul de l'installation du système de condensation de l'eau et de ses composants.

#### **Quels sont les avantages du système Waterin ?**

Waterin est un système écologique à condensation par eau qui offre de multiples avantages dans le domaine de la réfrigération commerciale. Une meilleure efficacité énergétique, un impact environnemental réduit et un meilleur contrôle de la température ne sont que quelques-uns de ses avantages.



# Waterin

## Sistema Waterloop R290 de Infrico

Unidades R290 condensados por agua de Temperatura Positiva.  
R290 units, Positive Temperature water condensed.  
Unités R290 à condensation par eau à Température Positive.

Unidades R290 condensados por agua de Temperatura Negativa.  
R290 units, Negative Temperature water condensed.  
Unités R290 à condensation par eau à Température négative.



**Posibilidad de recuperación de calor para calefacción o agua caliente sanitaria.**

**Possibility of heat recovery for heating or sanitary hot water.**

**Possibilité de récupération de chaleur pour le chauffage ou l'eau chaude sanitaire.**

Unidades R290 condensados por agua de Temperatura Positiva.  
R290 units, Positive Temperature water condensed.  
Unités R290 à condensation par eau à Température Positive.

9



**VEXW**

VEX (9-12-18-25-31-37) W-IW  
VEX (9-12-18-25-31-37) WCP-IWCP  
VEX (9-12-15-18-25) WCB-IWCB  
VEX (90) AAW-ACW-AIW-ACIW  
VEX (45) ACW-ACIW  
VEX (90) AAWCP-ACWCP-AAIWCP-ACIWCP  
VEX (45) ACWCP-ACIWCP



**GDW**

GD25WL1  
GD21WL1  
GDCWL1



Dry Coolers con grupo hidráulico.  
Dry Coolers with hydraulic power unit.  
Dry Coolers avec unité hydraulique.

Unidades R290 condensados por agua de Temperatura Negativa.  
R290 units, Negative Temperature water condensed.  
Unités R290 à condensation par eau à Température négative.

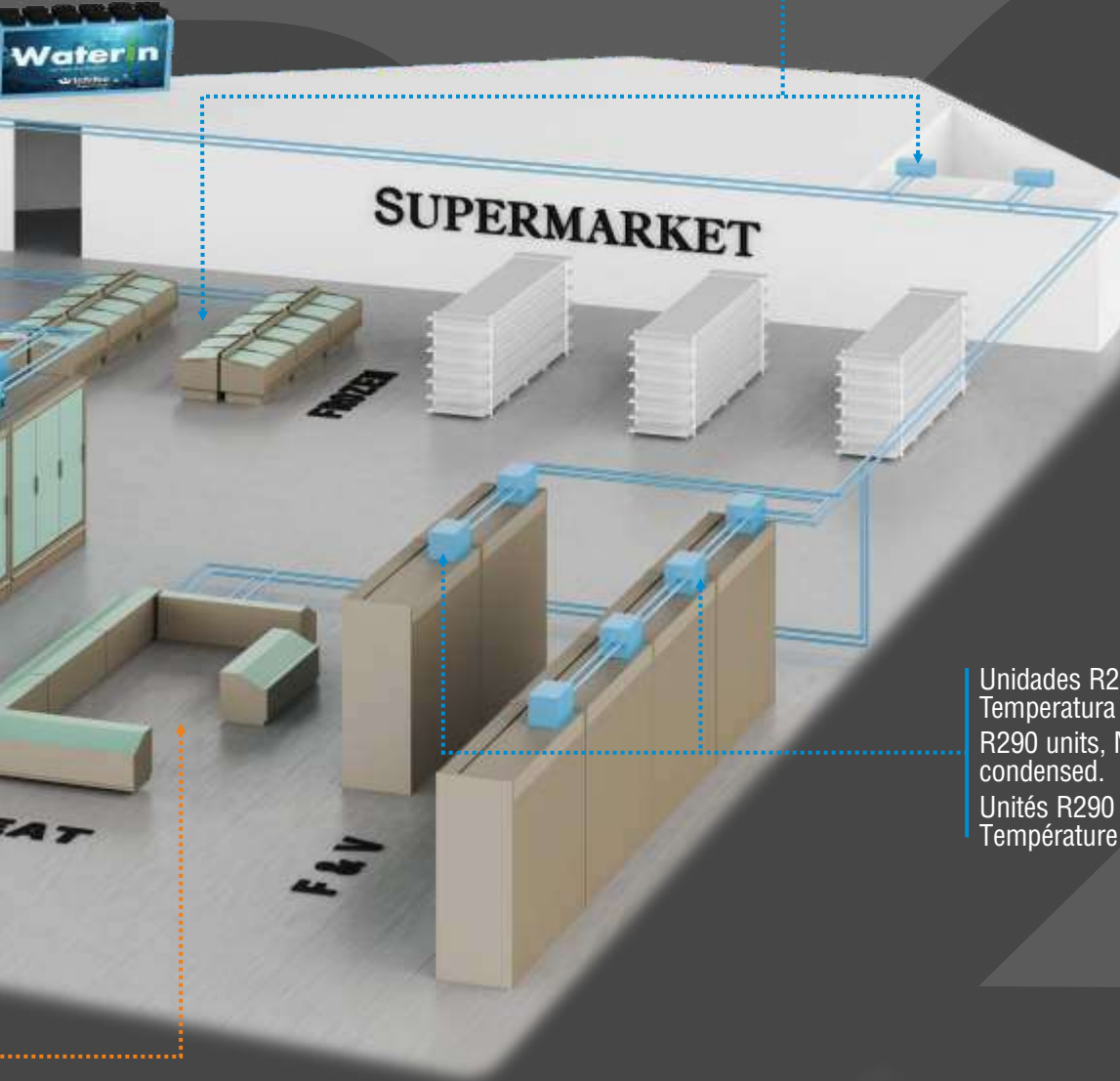

Unidades R290 condensados por agua de Temperatura Negativa.  
R290 units, Negative Temperature water condensed.  
Unités R290 à condensation par eau à Température négative.

















AS25WL1

## AS25W



# Vitrina expositora modular frío ventilado grupo incorporado / Refrigerated modular plugin display case / Vitrine présentation froid ventilé canalisable groupe incorporé

		CON RESERVA / WHIT STORAGE / AVEC RÉSERVE - RIU: Plano Inox / Stainless Steel exhibition plan / Plan d'exposition Inox						
MODELO MODELE MODÈLE								
Precio Price Prix	RU RIU							
		SIN RESERVA / WHITOUT STORAGE / SANS RÉSERVE - SIU: Plano Inox / Stainless Steel exhibition plan / Plan d'exposition Inox						
MODELO MODELE MODÈLE								
Precio Price Prix	SU SIU							
Medidas Measures Mesures	[mm]	938 x 1150 x 1290 mm.	1250 x 1150 x 1290 mm.	1562 x 1150 x 1290 mm.	1875 x 1150 x 1290 mm.	2500 x 1150 x 1290 mm.	3125 x 1150 x 1290 mm.	3750 x 1150 x 1290 mm.
Temperatura Temperature Température	[°C]	0°C/+6°C						
Clase Climática Climatic class Classe climatique	[°C]	4 / 30°C						
Tensión/Frecuencia Electrical data Tension électrique		230V/1ph/50Hz						
Controlador Controller Régulateur		Digital						
Material Matériel [EXT/INT]		Ext: acero plastificado / Plastified stainless steel / Acier plastifié Encimera / Worktop / Dessous: Inox Aisi 304 Plano exposición / Exhibition plan / Plan d'exposition: Acero plastif. / Plastif. Stainless steel/ Acier plastifié [Mod RU/SU] - Inox Aisi 304 [Mod. RIU/SIU]						
Aislamiento Isolation Isolation	[mm]	40kg/m <sup>3</sup> / Free CFC's / Zero ODP-GWP						
Capacidad Capacity Capacité	[L]	124	165	206	248	330	413	495
Superficie exposición Surface exhibition Surface d'exposition	[m <sup>2</sup> ]	0,96	1,28	1,59	1,91	2,55	3,19	3,83
Compresor Compressor Compresseur	[HP]	1/3	1/3	1/2	3/4	1	3/4	3/4
Estantes Shelving Étagères		1						
Costados (2) Sides (2) Joues (2)	[mm]	30+30						
Sistema de frío Cooling System Système de froid		Ventilado / Ventilated / Ventilé						
Desescarche Defrost Dégivrage		Automático / Automatic / Automatique						
Evaporación Evaporation Évaporation		Forzada / Forced / Ventilé						
Potencia Power Puissance	[W]	385	395	530	581	767	1324	1341
Potencia frig. Cooling capacity Puissance Frig.	[W A -10°C]	-	-	-	-	-	-	-
Consumo Consumption Consommation	[kWh/ 24h]	4.61	4.74	6.36	6.98	9.21	15.9	16.1
Refrigerante Refrigerant		R-290						
Opcional Optional Options	Puertas correderas traseras / Rear sliding doors / Portes coulissantes arrière							
	(PUEV9CT)	(PUEV12CT)	(PUEV15CT)	(PUEV18CT)	(PUEV25CT)	(PUEV31CT)	(PUEV37CT)	
	Cortinas traseras nocturnas / Night curtains / Rideaux de nuit							
	(CCNV9)	(CCNV12)	(CCNV15)	(CCNV18)	(CCNV25)	(CCNV31)	(CCNV37)	
Doble plano [sin reserva] / Double surface [without storage] / Double plan [sans réserve] - / INOX								
(DPEXVMDBC9S)	(DPEXVMDBC12S)	(DPEXVMDBC15S)	(DPEXVMDBC18S)	(DPEXVMDBC25S)	(DPEXVMDBC31S)	(DPEXVMDBC37S)		
(DPEXVMD9SI)	(DPEXVMD12SI)	(DPEXVMD15SI)	(DPEXVMD18SI)	(DPEXVMD25SI)	(DPEXVMD31SI)	(DPEXVMD37SI)		

**Laterales no incluidos en el precio**  
Side panels not included in price  
Joues non incluses dans le prix

Serie / Series / Série **MADRID**

+Info: [www.infrico.com](http://www.infrico.com)

VMD 25 RU



**Detalle reserva**  
Storage detail  
Détail réserve

**Laterales / Sides / Joues**

NO	
Izquierdo Left Gauche	Derecho Right Droite



VMD 18 SU

**Ext. Estándar / Standar / Standard**

Blanco/White/ Blanc	Ral 1001	Ral 1018
Ral 2003	Ral 3003	Ral 3020
Design 2108025	Ral 5015	Ral 4007
Ral 6002	Design 1107060	Design 3504035
Ral 9006	Ral 7016	Ral 8017

**Colores fuera de carta /  
Colors outside of letter /  
Couleurs spéciales, hors palette**

RAL		NO RAL	
Epoxi	Líquida/ Liquid/ Liquide	Epoxi	Líquida/ Liquid/ Liquide
	<b>508 €</b>	Consultar / Consulter / Consulter	
[x unidad/x unit/x unité]			
+10 días laborables / +10 work days / +10 jours ouvrés		Consultar / Consulter / Consulter	

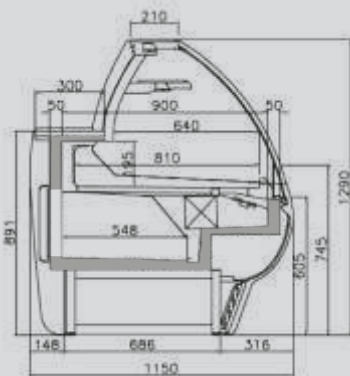



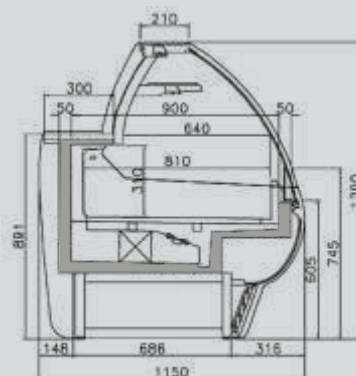











**VMD R (con reserva)**  
[Whit storage]  
[Avec réserve]



**VMD S [Sin reserva]**  
[Whitout storage]  
[Sans réserve]



# Vitrina expositora modular frío ventilado grupo remoto / Refrigerated modular display remote case / Vitrine présentation froid ventilé canalisable groupe à distance

		CON RESERVA / WHIT STORAGE / AVEC RÉSERVE - RI: Plano Inox / Stainless Steel exhibition plan / Plan d'exposition Inox						
MODELO MODELE MODÈLE								
Precio Price Prix	R RI							
		SIN RESERVA / WHITOUT STORAGE / SANS RÉSERVE - SI: Plano Inox / Stainless Steel exhibition plan / Plan d'exposition Inox						
MODELO MODELE MODÈLE								
Precio Price Prix	S SI							
Medidas Mesures Mesures	(mm)	938 x 1150 x 1290 mm.	1250 x 1150 x 1290 mm.	1562 x 1150 x 1290 mm.	1875 x 1150 x 1290 mm.	2500 x 1150 x 1290 mm.	3125 x 1150 x 1290 mm.	3750 x 1150 x 1290 mm.
Temperatura Temperature Température	(°C)	0°C/+6°C						
Clase Climática Climatic class Classe climatique	(°C)	4 / 30°C						
Tensión/Frecuencia Electrical data Tension électrique		230V/1ph/50Hz						
Controlador Controller Régulateur		Digital						
Material Matériel Matériel	[EXT/INT]	Ext: acero plastificado / Plastified stainless steel / Acier plastifié Encimera / Worktop / Dessous: Inox Aisi 304 Plano exposición / Exhibition plan / Plan d'exposition: Acero plastif./Plastif. Stainless steel/ Acier plastifié (Mod R/S) - Inox Aisi 304 (Mod. RI/SI)						
Aislamiento Isolation Isolation	(mm)	40kg/m <sup>3</sup> / Free CFC's / Zero ODP-GWP						
Capacidad Capacity Capacité	(L)	124	165	206	248	330	413	495
Superficie exposición Surface exhibition Surface d'exposition	(m <sup>2</sup> )	0,96	1,28	1,59	1,91	2,55	3,19	3,83
Compresor Compressor Compresseur	(HP)	-	-	-	-	-	-	-
Estantes Shelving Étagères		1						
Costados (2) Sides (2) Joues (2)	(mm)	30+30						
Sistema de frío Cooling System Système de froid		Ventilado / Ventilated / Ventilé						
Desescarche Defrost Dégivrage		Automático / Automatic / Automatique						
Evaporación Evaporation Évaporation		Forzada / Forced / Ventilé						
Potencia Power Puissance	(W)	-	-	-	-	-	-	-
Potencia frig. Cooling capacity Puissance Frig.	(W A -10°C)	-	-	-	-	-	-	-
Consumo Consumption Consommation	(kWh/ 24h)	556	741	926	1112	1483	1853	2224
Refrigerante Refrigerant Gaz		R-290						
Opcional Optional Options		Puertas correderas traseras / Rear sliding doors / Portes coulissantes arrière						
		(PUEV9CT)	(PUEV12CT)	(PUEV15CT)	(PUEV18CT)	(PUEV25CT)	(PUEV31CT)	(PUEV37CT)
		Cortinas traseras nocturnas / Night curtains / Rideaux de nuit						
		(CCNV9)	(CCNV12)	(CCNV15)	(CCNV18)	(CCNV25)	(CCNV31)	(CCNV37)
		Doble plano [sin reserva] / Double surface [without storage] / Double plan [sans réserve]						
		(DPEXVMDBC9S)	(DPEXVMDBC12S)	(DPEXVMDBC15S)	(DPEXVMDBC18S)	(DPEXVMDBC25S)	(DPEXVMDBC31S)	(DPEXVMDBC37S)

Laterales no incluidos en el precio  
Side panels not included in price  
Joues non incluses dans le prix

Serie / Series / Série **MADRID**

+Info: [www.infrico.com](http://www.infrico.com)

VMD 18 SU



Laterales / Sides / Joutes

NO	
Izquierdo Left Gauche	Derecho Right Droite



VMD 25 RI



Detalle reserva  
Storage detail  
Détail réserve

Ext. Estándar / Standar / Standard

Blanco/White/ Blanc	Ral 1001	Ral 1018
Ral 2003	Ral 3003	Ral 3020
Design 2108025	Ral 5015	Ral 4007
Ral 6002	Design 1107060	Design 3504035
Ral 9006	Ral 7016	Ral 8017

Colores fuera de carta /  
Colors outside of letter /  
Couleurs spéciales, hors palette

RAL		NO RAL	
Epoxi	Líquida/ Liquid/ Liquide	Epoxi	Líquida/ Liquid/ Liquide
[x unidad/x unit/x unité]		Consultar / Consulter / Consulter	
+10 días laborables / +10 work days / +10 jours ouvrés		Consultar / Consulter / Consulter	

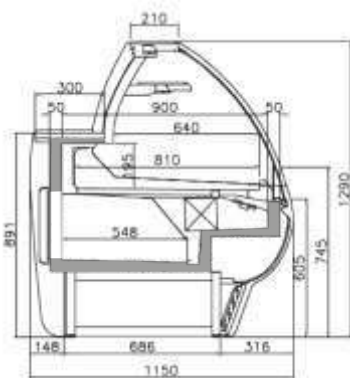



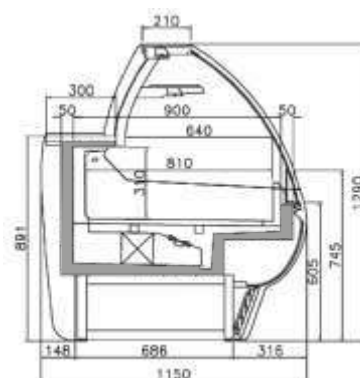







VMD R (con reserva)  
[Whit storage]  
[Avec réserve]



VMD S [Sin reserva]  
[Whitout storage]  
[Sans réserve]

**Vitrina expositora modular frío ventilado grupo incorporado /**  
**Refrigerated modular plugin display case /**  
**Vitrine présentation froid ventilé canalisable groupe incorporé**

**Mueble caja /**  
**Counter case /**  
**Meuble de comptoir**

		CON RESERVA / WHIT STORAGE / AVEC RÉSERVE RIU: Plano Inox / Stainless Steel exhibition plan / Plan d'exposition Inox				MUEBLE CAJA / COUNTER CASE / MEUBLE DE COMPTOIR		
MODELO MODELE MODÈLE								
		VMD 90 AA RU/RIU	VMD 45 AA RU/RIU	VMD 90 AC RU/RIU	VMD 45 AC RU/RIU	VMD 9 C	VMD 12 M	VMD 15 M
Precio Price Prix	RU RIU							
		SIN RESERVA / WHITOUT STORAGE / SANS RÉSERVE SIU: Plano Inox / Stainless Steel exhibition plan / Plan d'exposition Inox						
MODELO MODELE MODÈLE						-	-	-
		VMD 90 AA SU/SIU	VMD 45 AA SU/SIU	VMD 90 AC SU/SIU	VMD 45 AC SU/SIU	-	-	-
Precio Price Prix	SU SIU					-	-	-
Medidas Measures Mesures	[mm]	1326 x 1150 x 1290 mm.	1108 x 1150 x 1290 mm.	1887 x 1150 x 1290 mm.	1470 x 1150 x 1290 mm.	938 x 1150 x 906 mm.	1250 x 1150 x 906 mm.	1562 x 1150 x 906 mm.
Temperatura Temperature Température	[°C]	0°C/+6°C				-		
Clase Climática Climatic class Classe climatique	[°C]	4 / 30°C				-		
Tensión/Frecuencia Electrical data Tension électrique		230V/1ph/50Hz				-		
Controlador Controller Régulateur		Digital				-		
Material Matériel	[EXT/INT]	Ext: acero plastificado / Plastified stainless steel / Acier plastifié Encimera / Worktop / Dessous: Inox Aisi 304 Plano exposición / Exhibition plan / Plan d'exposition: Acero plastif./ Plastif. Stainless steel/ Acier plastifié [Mod RU/SU] - Inox Aisi 304 [Mod. RIU/SIU]						
Aislamiento Isolation Isolation	[mm]	40kg/m <sup>3</sup> / Free CFC's / Zero ODP-GWP				-		
Capacidad Capacity Capacité	[L]	-	-	-	-	-	-	-
Superficie exposición Surface exhibition Surface d'exposition	[m <sup>2</sup> ]	1,15	0,63	1,49	0,75	0,55	0,74	0,92
Compresor Compressor Compresseur	[HP]	5/8	3/8	3/4	1/2	-	-	-
Estantes Shelving Étagères		1				-		
Costados (2) Sides (2) Joues (2)	[mm]					30+30		
Sistema de frío Cooling System Système de froid		Ventilado / Ventilated / Ventilé				-		
Desescarche Defrost Dégivrage		Automático / Automatic / Automatique				-		
Evaporación Evaporation Évaporation		Forzada / Forced / Ventilé				-		
Potencia Power Puissance	[W]	990	670	1060	740	-	-	-
Potencia frig. Cooling capacity Puissance Frig.	[W A -10°C]	1096	676	1315	817	-	-	-
Consumo Consumption Consommation	[kWh/ 24h]	13,9	9,4	14,8	10,4	-	-	-
Refrigerante Refrigerant Gaz		R-290				-		
Opcional Optional Options		Puertas corred. tras. / Rear sliding doors / Portes couliss. arrière  [PUEV90AACT]	Puertas corred. tras. / Rear sliding doors / Portes couliss. arrière  [PUEV45AACT]	Puertas corred. tras. / Rear sliding doors / Portes couliss. arrière  [PUEV90ACCT]	Puertas corred. tras. / Rear sliding doors / Portes couliss. arrière  [PUEV45ACCT]	-		

**Laterales no incluidos en el precio**  
**Side panels not included in price**  
**Joues non incluses dans le prix**



Serie / Series / Série **MADRID**

+Info: [www.infrico.com](http://www.infrico.com)

**Lineal VMD**  
VMD Linear assembly  
Assemblage lineaire VMD

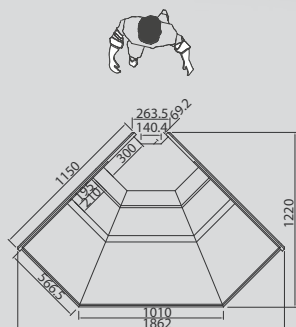
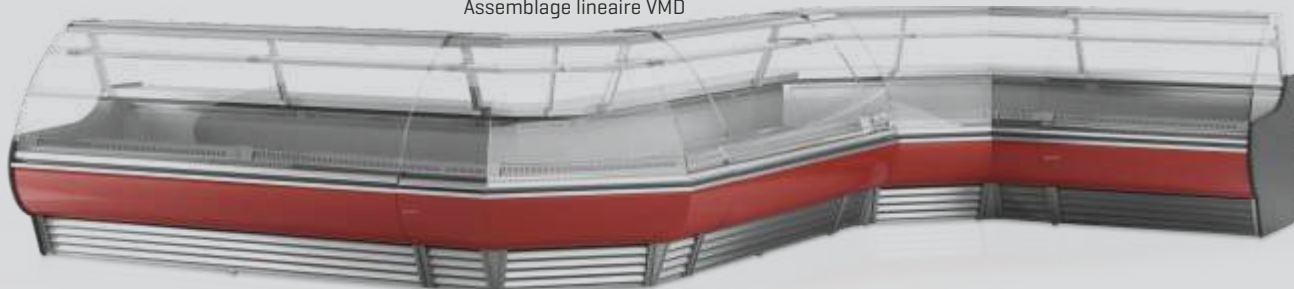

VMD 90 AA RU

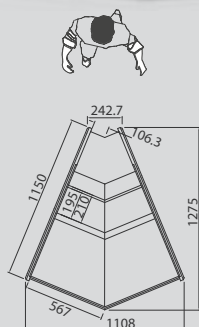

VMD 45 AA RU

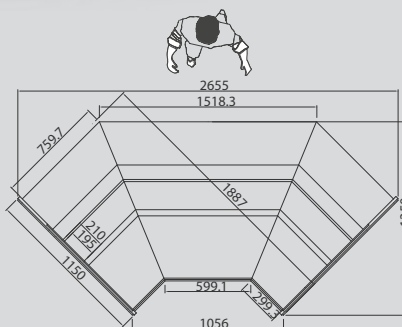

VMD 90 AC RU

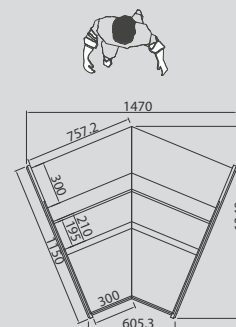

VMD 45 AC RU

**Laterales / Sides / Joes**

**VMD C/M: SÍ**

**Laterales / Sides / Joes**

**VMD 90/45: NO**

Izquierdo Left Gauche	Derecho Right Droite
-----------------------------	----------------------------

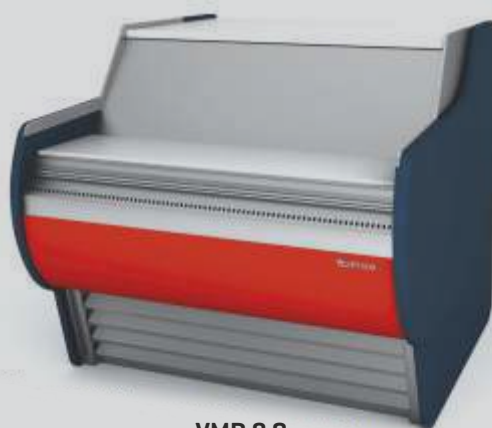

VMD 9 C

**Ext. Estándar / Standar / Standard**

Blanco/White/ Blanc	Ral 1001	Ral 1018
Ral 2003	Ral 3003	Ral 3020
Design 2108025	Ral 5015	Ral 4007
Ral 6002	Design 1107060	Design 3504035
Ral 9006	Ral 7016	Ral 8017

**Colores fuera de carta /  
Colors outside of letter /  
Couleurs spéciales, hors palette**

RAL		NO RAL	
Epoxi	Líquida/ Liquid/ Liquide	Epoxi	Líquida/ Liquid/ Liquide
[x unidad/x unit/x unité]		Consultar / Consulter / Consulter	
+10 días laborables / +10 work days / +10 jours ouvrés		Consultar / Consulter / Consulter	













VMD 12 M



**Vitrina expositora modular frío ventilado grupo remoto /**  
**Refrigerated modular display remote case /**  
**Vitrine présentation froid ventilé canalisable groupe à distance**

**Mueble caja /**  
**Counter case /**  
**Meuble de comptoir**

		CON RESERVA / WHIT STORAGE / AVEC RÉSERVE RI: Plano Inox / Stainless Steel exhibition plan / Plan d'exposition Inox				MUEBLE CAJA / COUNTER CASE / MEUBLE DE COMPTOIR		
MODELO MODELE MODÈLE								
		VMD 90 AA R/RI	VMD 45 AA R/RI	VMD 90 AC R/RI	VMD 45 AC R/RI	VMD 9 C	VMD 12 M	VMD 15 M
Precio Price Prix	R RI							
MODELO MODELE MODÈLE		SIN RESERVA / WHITOUT STORAGE / SANS RÉSERVE SI: Plano Inox / Stainless Steel exhibition plan / Plan d'exposition Inox						
						-	-	-
		VMD 90 AA S/SI	VMD 45 AA S/SI	VMD 90 AC S/SI	VMD 45 AC S/SI	-	-	-
Precio Price Prix	S SI							
Medidas Measures Mesures	[mm]	1326 x 1150 x 1290 mm.	1108 x 1150 x 1290 mm.	1887 x 1150 x 1290 mm.	1470 x 1150 x 1290 mm.	938 x 1150 x 906 mm.	1250 x 1150 x 906 mm.	1562 x 1150 x 906 mm.
Temperatura Temperature Température	[°C]	0°C/+6°C						
Clase Climática Climatic class Classe climatique	[°C]	4 / 30°C						
Tensión/Frecuencia Electrical data Tension électrique		230V/1ph/50Hz						
Controlador Controller Régulateur		Digital						
Material Matériel	[EXT/INT]	Ext: acero plastificado / Plastified stainless steel / Acier plastifié Encimera / Worktop / Dessous: Inox Aisi 304 Plano exposición / Exhibition plan / Plan d'exposition: Acero plastif./Plastif. Stainless steel/ Acier plastifié (Mod R/S) - Inox Aisi 304 (Mod. RI/SI)						
Aislamiento Isolation Isolation	[mm]	40kg/m <sup>3</sup> / Free CFC's / Zero ODP-GWP						
Capacidad Capacity Capacité	[L]	-	-	-	-	-	-	-
Superficie exposición Surface exhibition Surface d'exposition	[m <sup>2</sup> ]	1,15	0,63	1,49	0,75	0,55	0,74	0,92
Compresor Compressor Compresseur	[HP]	-	-	-	-	-	-	-
Estantes Shelving Étagères		1						
Costados (2) Sides (2) Joues (2)	[mm]	30+30						
Sistema de frío Cooling System Système de froid		Ventilado / Ventilated / Ventilé						
Desescarche Defrost Dégivrage		Automático / Automatic / Automatique						
Evaporación Evaporation Évaporation		Forzada / Forced / Ventilé						
Potencia Power Puissance	[W]	-	-	-	-	-	-	-
Potencia frig. Cooling capacity Puissance Frig.	[W A -10°C]	780	391	1151	777	-	-	-
Consumo Consumption Consommation	[kWh/ 24h]	-	-	-	-	-	-	-
Refrigerante Refrigerant Gaz		R-290						
Opcional Optional Options		Puertas corred. tras. / Rear sliding doors / Portes couliss. arrière  [PUEV90AACT]	Puertas corred. tras. / Rear sliding doors / Portes couliss. arrière  [PUEV45AACT]	Puertas corred. tras. / Rear sliding doors / Portes couliss. arrière  [PUEV90ACCT]	Puertas corred. tras. / Rear sliding doors / Portes couliss. arrière  [PUEV45ACCT]			

**Laterales no incluidos en el precio**  
**Side panels not included in price**  
**Joues non incluses dans le prix**



Serie / Series / Série **MADRID**

+Info: [www.infrico.com](http://www.infrico.com)

**Lineal VMD**  
VMD Linear assembly  
Assemblage lineaire VMD

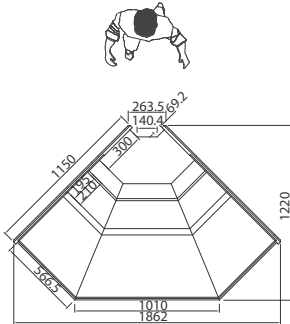
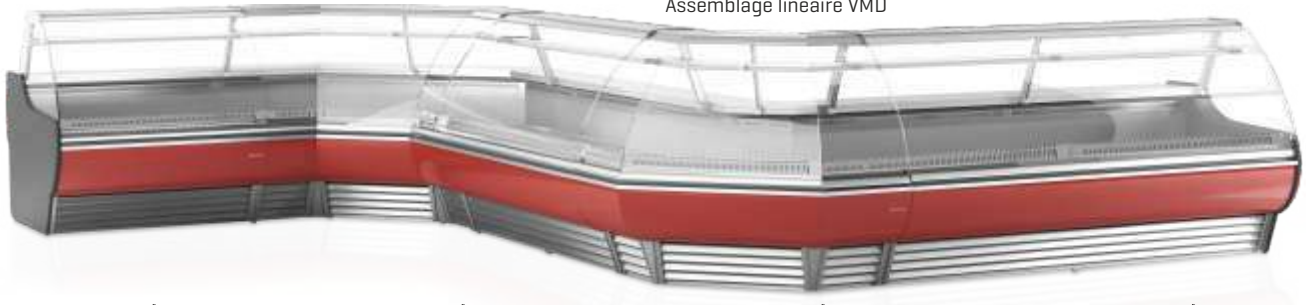

VMD 90 AA R

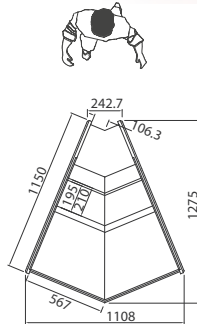

VMD 45 AA R

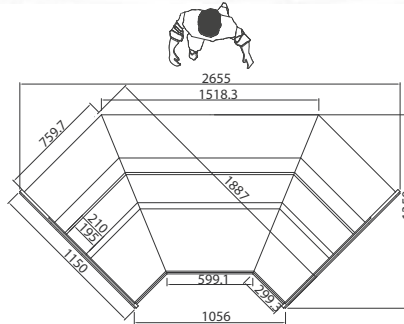

VMD 90 AC R

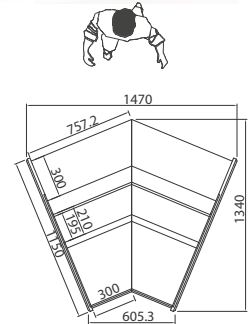

VMD 45 AC R

**Laterales / Sides / Jous**

**VMD C/M: SÍ**

**Laterales / Sides / Jous**

VMD 90/45: NO	
Izquierdo Left Gauche	Derecho Right Droite



VMD 12 M

**Ext. Estándar / Standar / Standard**

Blanco/White/ Blanc	Ral 1001	Ral 1018
Ral 2003	Ral 3003	Ral 3020
Design 2108025	Ral 5015	Ral 4007
Ral 6002	Design 1107060	Design 3504035
Ral 9006	Ral 7016	Ral 8017

**Colores fuera de carta /  
Colors outside of letter /  
Couleurs spéciales, hors palette**

RAL		NO RAL	
Epoxi	Líquida/ Liquid/ Liquide	Epoxi	Líquida/ Liquid/ Liquide
[x unidad/x unit/x unité]		Consultar / Consulter / Consulter	
+10 días laborables / +10 work days / +10 jours ouvrés		Consultar / Consulter / Consulter	

















VMD 9 C



# Vitrina expositora modular frío ventilado grupo incorporado / Refrigerated modular plugin display case / Vitrine présentation froid ventilé canalisable groupe incorporé

CON RESERVA / WITH STORAGE / AVEC RÉSERVE - RIU: Plano Inox / Stainless Steel exhibition plan / Plan d'exposition Inox

MODELO MODELE MODÈLE								
Precio Price Prix	RU RIU							
MODELO MODELE MODÈLE								
Precio Price Prix	SU SIU							
		SIN RESERVA / WITHOUT STORAGE / SANS RÉSERVE - SIU: Plano Inox / Stainless Steel exhibition plan / Plan d'exposition Inox						
Medidas Measures Mesures	[mm]	938 x 1150 x 1290 mm.	1250 x 1150 x 1290 mm.	1562 x 1150 x 1290 mm.	1875 x 1150 x 1290 mm.	2500 x 1150 x 1290 mm.	3125 x 1150 x 1290 mm.	3750 x 1150 x 1290 mm.
Temperatura Temperature Température	[°C]	0°C/+6°C						
Clase Climática Climatic class Classe climatique	[°C]	4 / 30°C						
Tensión/Frecuencia Electrical data Tension électrique		230V/1ph/50Hz						
Controlador Controller Régulateur		Digital						
Material Matériel	[EXT/INT]	Ext: acero plastificado / Plastified stainless steel / Acier plastifié Encimera / Worktop / Dessous: Inox Aisi 304 Plano exposición / Exhibition plan / Plan d'exposition: Acero plastif. / Plastif. Stainless steel/ Acier plastifié [Mod RU/SU] - Inox Aisi 304 [Mod. RIU/SIU]						
Aislamiento Isolation Isolation	[mm]	40kg/m <sup>3</sup> / Free CFC's / Zero ODP-GWP						
Capacidad Capacity Capacité	[L]	82	109	137	164	219	273	328
Superficie exposición Surface exhibition Surface d'exposition	[m <sup>2</sup> ]	0,92	1,23	1,53	1,84	2,45	3,06	3,68
Compresor Compressor Compresseur	[HP]	1/3	1/2	3/4	3/4	1+1/4	1+1/4	1+1/4
Estantes Shelving Étagères		1						
Costados (2) Sides (2) Joues (2)	[mm]	30+30						
Sistema de frío Cooling System Système de froid		Ventilado / Ventilated / Ventilé						
Desescarche Defrost Dégivrage		Automático / Automatic / Automatique						
Evaporación Evaporation Évaporation		Forzada / Forced / Ventilé						
Potencia Power Puissance	[W]	394	531	590	681	1115	2166	2190
Potencia frig. Cooling capacity Puissance Frig.	[W A -10°C]	-	-	-	-	-	-	-
Consumo Consumption Consommation	[kWh/ 24h]	5.18	7.01	7.8	8.9	14.6	28.6	28.9
Refrigerante Refrigerant Gaz		R-290						
Opcional Optional Options	Puertas correderas traseras / Rear sliding doors / Portes coulissantes arrière							
	(PUEV9CT)	(PUEV12CT)	(PUEV15CT)	(PUEV18CT)	(PUEV25CT)	(PUEV31CT)	(PUEV37CT)	
	Cortinas traseras nocturnas / Night curtains / Rideaux de nuit							
	(CCNV9)	(CCNV12)	(CCNV15)	(CCNV18)	(CCNV25)	(CCNV31)	(CCNV37)	
Opcional Optional Options	Cristal calefactado curvo / Heated curved frontal glass / Vitre bombé chauffée							
	(CRCCTVEU9)	(CRCCTVEU12)	(CRCCTVEU15)	(CRCCTVEU18)	(CRCCTVEU25)	(CRCCTVEU31)	(CRCCTVEU37)	

Laterales no incluidos en el precio  
Side panels not included in price  
Joues non incluses dans le prix

Serie / Series / Série **BARCELONA**

+Info: [www.infrico.com](http://www.infrico.com)

VBC 15 RU



Laterales / Sides / Joutes

NO	
Izquierdo Left Gauche	Derecho Right Droite



Ext. Estándar / Standar / Standard

Blanco/White/ Blanc	Ral 1001	Ral 1018
Ral 2003	Ral 3003	Ral 3020
Design 2108025	Ral 5015	Ral 4007
Ral 6002	Design 1107060	Design 3504035
Ral 9006	Ral 7016	Ral 8017

Colores fuera de carta /  
Colors outside of letter /  
Couleurs spéciales, hors palette

RAL		NO RAL	
Epoxi	Líquida/ Liquid/ Liquide	Epoxi	Líquida/ Liquid/ Liquide
		Consultar / Consultar / Consulter	
[x unidad/x unit/x unité]			
+10 días laborables / +10 work days / +10 jours ouvrés		Consultar / Consultar / Consulter	

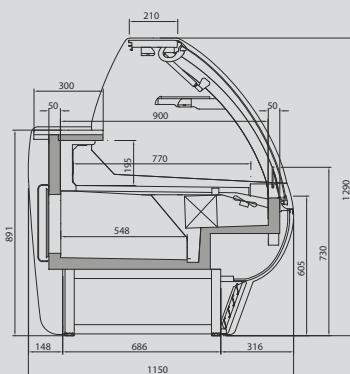

VBC RU/RIU (con reserva)  
[Whit storage]  
[Avec réserve]

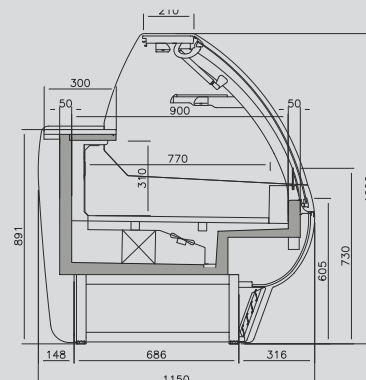













VBC SU/SIU (Sin reserva)  
[Whitout storage]  
[Sans réserve]



**Vitrina expositora modular frío ventilado grupo incorporado /**  
**Refrigerated modular plugin display case /**  
**Vitrine présentation froid ventilé canalisable groupe incorporé**

**Mueble caja /**  
**Counter case /**  
**Meuble de comptoir**

		CON RESERVA / WHIT STORAGE / AVEC RÉSERVE RIU: Plano Inox / Stainless Steel exhibition plan / Plan d'exposition Inox				MUEBLE CAJA / COUNTER CASE / MEUBLE DE COMPTOIR			
MODELO MODELE MODÈLE									
Precio Price Prix	RU RIU								
MODELO MODELE MODÈLE		SIN RESERVA / WHITOUT STORAGE / SANS RÉSERVE SIU: Plano Inox / Stainless Steel exhibition plan / Plan d'exposition Inox							
MODELO MODELE MODÈLE						-	-	-	-
Precio Price Prix	SU SIU								
<b>Medidas</b> Measures Mesures	[mm]	1326 x 1150 x 1290 mm.	1108 x 1150 x 1290 mm.	1887 x 1150 x 1290 mm.	1470 x 1150 x 1290 mm.	938 x 1150 x 906 mm.	1250 x 1150 x 906 mm.	1562 x 1150 x 906 mm.	1250 x 1150 x 906 mm.
<b>Temperatura</b> Temperature Température	[°C]	0°C/+6°C							
<b>Clase Climática</b> Climatic class Classe climatique	[°C]	4 / 30°C							
<b>Tensión/Frecuencia</b> Electrical data Tension électrique		230V/1ph/50Hz							
<b>Controlador</b> Controller Régulateur		Digital							
<b>Material</b> Matériel	[EXT/INT]	Ext: acero plastificado / Plastified stainless steel / Acier plastifié Encimera / Worktop / Dessous: Inox Aisi 304 Plano exposición / Exhibition plan / Plan d'exposition: Acero plastif./ Plastif. Stainless steel/ Acier plastifié (Mod RU/SU) - Inox Aisi 304 (Mod. RIU/SIU)							
<b>Aislamiento</b> Isolation Isolation	[mm]	40kg/m <sup>3</sup> / Free CFC's / Zero ODP-GWP							
<b>Capacidad</b> Capacity Capacité	[L]	-	-	-	-	-	-	-	-
<b>Superficie exposición</b> Surface exhibition Surface d'exposition	[m <sup>2</sup> ]	1,09	0,60	1,43	0,72	0,55	0,74	0,92	
<b>Compresor</b> Compressor Compresseur	[HP]	5/8	3/8	3/4	1/2	-	-	-	
<b>Estantes</b> Shelving Étagères		1							
<b>Costados (2)</b> Sides (2) Joues (2)	[mm]	30+30							
<b>Sistema de frío</b> Cooling System Système de froid		Ventilado / Ventilated / Ventilé							
<b>Desescarche</b> Defrost Dégivrage		Automático / Automatic / Automatique							
<b>Evaporación</b> Evaporation Évaporation		Forzada / Forced / Ventilé							
<b>Potencia</b> Power Puissance	[W]	1025	700	1110	780	-	-	-	-
<b>Potencia frig.</b> Cooling capacity Puissance Frig.	[W A -10°C]	-	-	-	-	-	-	-	-
<b>Consumo</b> Consumption Consommation	[kWh/ 24h]	14,4	9,8	15,5	10,9	-	-	-	-
<b>Refrigerante</b> Refrigerant Gaz		R-290							
<b>Opcional</b> Optional Options		<b>Puertas correderas tras. /</b> Rear sliding doors / Portes couliss. arrière  (PUEVBC90AACT)	<b>Puertas correderas tras. /</b> Rear sliding doors / Portes couliss. arrière  (PUEVBC45AACT)	<b>Puertas correderas tras. /</b> Rear sliding doors / Portes couliss. arrière  (PUEVBC90ACCT)	<b>Puertas correderas tras. /</b> Rear sliding doors / Portes couliss. arrière  (PUEVBC45ACCT)				

**Laterales no incluidos en el precio**  
**Side panels not included in price**  
**Joues non incluses dans le prix**

Serie / Series / Série **BARCELONA**

+Info: [www.infrico.com](http://www.infrico.com)

**Lineal VBC**  
VBC Linear assembly  
Assemblage lineaire VBC

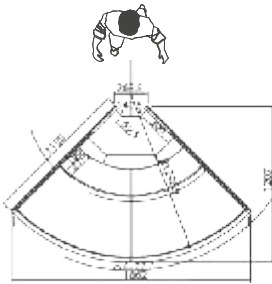

VBC 90 AA RU/RIU  
VBC 90 AA SU/SIU

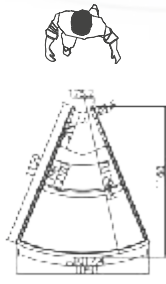

VBC 45 AA RU/RIU  
VBC 45 AA SU/SIU

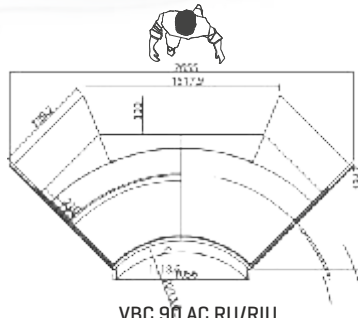

VBC 90 AC RU/RIU  
VBC 90 AC SU/SIU

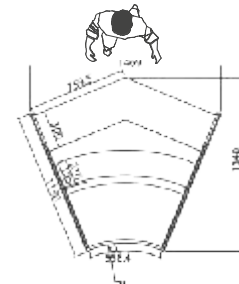

VBC 45 AC RU/RIU  
VBC 45 AC SU/SIU

**Laterales / Sides / Joes**

**VBC C/M/MHD: SÍ**

**Laterales / Sides / Joes**

**VBC 90/45: NO**

Izquierdo Left Gauche	Derecho Right Droite
-----------------------------	----------------------------

**Ext. Estándar / Standar / Standard**

Blanco/White/ Blanc	Ral 1001	Ral 1018
Ral 2003	Ral 3003	Ral 3020
Design 2108025	Ral 5015	Ral 4007
Ral 6002	Design 1107060	Design 3504035
Ral 9006	Ral 7016	Ral 8017



VBC 12 M



VBC 9 C

**Colores fuera de carta /  
Colors outside of letter /  
Couleurs spéciales, hors palette**

RAL		NO RAL	
Epoxi	Líquida/ Liquid/ Liquide	Epoxi	Líquida/ Liquid/ Liquide
[x unidad/x unit/x unité]		Consultar / Consultar / Consulter	
+10 días laborables / +10 work days / +10 jours ouvrés		Consultar / Consultar / Consulter	

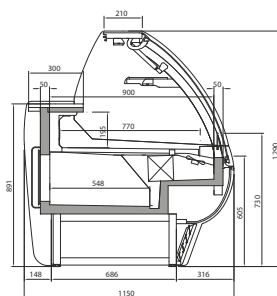

**VBC RU [con reserva]**  
[Whit storage][Avec réserve]

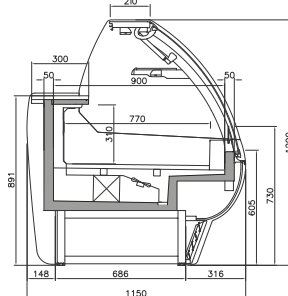



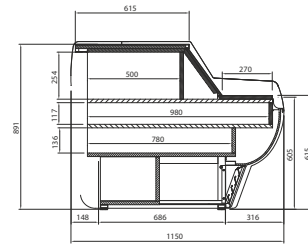











**VBC SU [Sin reserva]**  
[Whitout storage][Sans réserve]



**VBC**

# Vitrina expositora modular frío ventilado grupo remoto / Refrigerated modular display remote case / Vitrine présentation froid ventilé canalisable groupe à distance

CON RESERVA / WITH STORAGE / AVEC RÉSERVE - RI: Plano Inox / Stainless Steel exhibition plan / Plan d'exposition Inox

MODELO MODELE MODÈLE							
Precio Price Prix	R						
	RI						
	<b>SIN RESERVA / WITHOUT STORAGE / SANS RÉSERVE - SI: Plano Inox / Stainless Steel exhibition plan / Plan d'exposition Inox</b>						
MODELO MODELE MODÈLE							
Precio Price Prix	S						
	SI						
<b>Medidas</b> Mesures [mm]	938 x 1150 x 1290 mm.	1250 x 1150 x 1290 mm.	1562 x 1150 x 1290 mm.	1875 x 1150 x 1290 mm.	2500 x 1150 x 1290 mm.	3125 x 1150 x 1290 mm.	3750 x 1150 x 1290 mm.
<b>Temperatura</b> Temperature [°C] Température	0°C/+6°C						
<b>Clase Climática</b> Climatic class [°C] Classe climatique	4 / 30°C						
<b>Tensión/Frecuencia</b> Electrical data Tension électrique	230V/1ph/50Hz						
<b>Controlador</b> Controller Régulateur	Digital						
<b>Material</b> Matériel [EXT/INT]	Ext: acero plastificado / Plastified stainless steel / Acier plastifié Encimera / Worktop / Dessous: Inox Aisi 304 Plano exposición / Exhibition plan / Plan d'exposition: Acero plastif. / Plastif. Stainless steel/ Acier plastifié [Mod RU/SU] - Inox Aisi 304 [Mod. RIU/SIU]						
<b>Aislamiento</b> Isolation [mm]	40kg/m <sup>3</sup> / Free CFC's / Zero ODP-GWP						
<b>Capacidad</b> Capacity [L] Capacité	82	109	137	164	219	273	328
<b>Superficie exposición</b> Surface exhibition [m <sup>2</sup> ] Surface d'exposition	0,92	1,23	1,53	1,84	2,45	3,06	3,68
<b>Compresor</b> Compressor [HP] Compresseur	-	-	-	-	-	-	-
<b>Estantes</b> Shelving Étagères	1						
<b>Costados (2)</b> Sides (2) [mm] Joues (2)	30+30						
<b>Sistema de frío</b> Cooling System Système de froid	Ventilado / Ventilated / Ventilé						
<b>Desescarche</b> Defrost Dégivrage	Automático / Automatic / Automatique						
<b>Evaporación</b> Evaporation Évaporation	Forzada / Forced / Ventilé						
<b>Potencia</b> Power [W] Puissance	-	-	-	-	-	-	-
<b>Potencia frig.</b> Cooling capacity [W A -10°C] Puissance Frig.	623	830	1037	1245	1660	2075	2490
<b>Consumo</b> Consumption [kWh/ 24h] Consommation	-	-	-	-	-	-	-
<b>Refrigerante</b> Refrigerant Gaz	R-290						
<b>Opcional</b> Optional Options	<b>Puertas correderas traseras / Rear sliding doors / Portes coulissantes arrière</b>						
	(PUEV9CT)	(PUEV12CT)	(PUEV15CT)	(PUEV18CT)	(PUEV25CT)	(PUEV31CT)	(PUEV37CT)
	<b>Cortinas traseras nocturnas / Night curtains / Rideaux de nuit</b>						
	(CCNV9)	(CCNV12)	(CCNV15)	(CCNV18)	(CCNV25)	(CCNV31)	(CCNV37)
<b>Opcional</b> Optional Options	<b>Cristal calefactado curvo / Heated curved frontal glass / Vitre bombé chauffée</b>						
	(CRCCTVEU9)	(CRCCTVEU12)	(CRCCTVEU15)	(CRCCTVEU18)	(CRCCTVEU25)	(CRCCTVEU31)	(CRCCTVEU37)

**Laterales no incluidos en el precio**  
Side panels not included in price  
Joues non incluses dans le prix

Serie / Series / Série **BARCELONA**

+Info: [www.infrico.com](http://www.infrico.com)

VBC 15 RI



**Laterales / Sides / Joues**

NO	
Izquierdo Left Gauche	Derecho Right Droite



**Ext. Estándar / Standar / Standard**

Blanco/White/ Blanc	Ral 1001	Ral 1018
Ral 2003	Ral 3003	Ral 3020
Design 2108025	Ral 5015	Ral 4007
Ral 6002	Design 1107060	Design 3504035
Ral 9006	Ral 7016	Ral 8017

**Colores fuera de carta /  
Colors outside of letter /  
Couleurs spéciales, hors palette**

RAL		NO RAL	
Epoxi	Líquida/ Liquid/ Liquide	Epoxi	Líquida/ Liquid/ Liquide
[x unidad/x unit/x unité]		Consultar / Consultar / Consulter	
+10 días laborables / +10 work days / +10 jours ouvrés		Consultar / Consultar / Consulter	

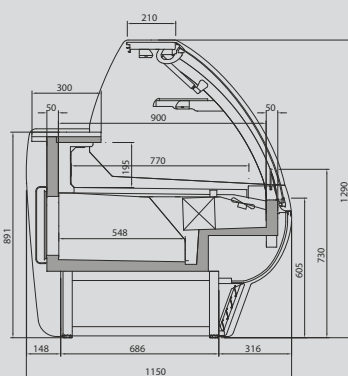

**VBC R/RI [con reserva]  
[Whit storage]  
[Avec réserve]**

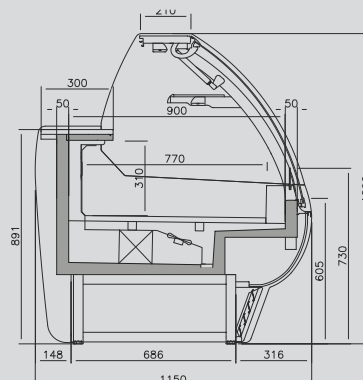













**VBC S/SI [Sin reserva]  
[Whitout storage]  
[Sans réserve]**



**Vitrina expositora modular frío ventilado grupo remoto /**  
**Refrigerated modular display remote case /**  
**Vitrine présentation froid ventilé canalisable groupe à distance**

**Mueble caja /**  
**Counter case /**  
**Meuble de comptoir**

		CON RESERVA / WHIT STORAGE / AVEC RÉSERVE RI: Plano Inox / Stainless Steel exhibition plan / Plan d'exposition Inox				MUEBLE CAJA / COUNTER CASE / MEUBLE DE COMPTOIR			
MODELO MODELE MODÈLE									
		VBC 90 AA R/RI	VBC 45 AA R/RI	VBC 90 AC R/RI	VBC 45 AC R/RI	VBC 9 C	VBC 12 M	VBC 15 M	VBC 12 MHD
Precio Price Prix	R RI								
MODELO MODELE MODÈLE		SIN RESERVA / WHITOUT STORAGE / SANS RÉSERVE SIU: Plano Inox / Stainless Steel exhibition plan / Plan d'exposition Inox							
						-	-	-	-
		VBC 90 AA S/SI	VBC 45 AA S/SI	VBC 90 AC S/SI	VBC 45 AC S/SI	-	-	-	-
Precio Price Prix	S SI								
Medidas Measures Mesures	[mm]	1326 x 1150 x 1290 mm.	1108 x 1150 x 1290 mm.	1887 x 1150 x 1290 mm.	1470 x 1150 x 1290 mm.	938 x 1150 x 906 mm.	1250 x 1150 x 906 mm.	1562 x 1150 x 906 mm.	1250 x 1150 x 906 mm.
Temperatura Temperature Température	[°C]	0°C/+6°C							
Clase Climática Climatic class Classe climatique	[°C]	4 / 30°C							
Tensión/Frecuencia Electrical data Tension électrique		230V/1ph/50Hz							
Controlador Controller Régulateur		Digital							
Material Matériel	[EXT/INT]	Ext: acero plastificado / Plastified stainless steel / Acier plastifié Encimera / Worktop / Dessous: Inox Aisi 304 Plano exposición / Exhibition plan / Plan d'exposition: Acero plastif./ Plastif. Stainless steel/ Acier plastifié (Mod RU/SU) - Inox Aisi 304 (Mod. RIU/SIU)							
Aislamiento Isolation Isolation	[mm]	40kg/m <sup>3</sup> / Free CFC's / Zero ODP-GWP							
Capacidad Capacity Capacité	[L]	-	-	-	-	-	-	-	-
Superficie exposición Surface exhibition Surface d'exposition	[m <sup>2</sup> ]	1,09	0,60	1,43	0,72	0,55	0,74	0,92	
Compresor Compressor Compresseur	[HP]	-	-	-	-	-	-	-	-
Estantes Shelving Étagères		1							
Costados (2) Sides (2) Joues (2)	[mm]	30+30							
Sistema de frío Cooling System Système de froid		Ventilado / Ventilated / Ventilé							
Desescarche Defrost Dégivrage		Automático / Automatic / Automatique							
Evaporación Evaporation Évaporation		Forzada / Forced / Ventilé							
Potencia Power Puissance	[W]	-	-	-	-	-	-	-	-
Potencia frig. Cooling capacity Puissance Frig.	[W A -10°C]	304	403	11598	801	-	-	-	-
Consumo Consumption Consommation	[kWh/ 24h]	-	-	-	-	-	-	-	-
Refrigerante Refrigerant Gaz		R-290							
Opcional Optional Options		Puertas correderas tras. / Rear sliding doors / Portes couliss. arrière  (PUEVBC90AACT)	Puertas correderas tras. / Rear sliding doors / Portes couliss. arrière  (PUEVBC45AACT)	Puertas correderas tras. / Rear sliding doors / Portes couliss. arrière  (PUEVBC90ACCT)	Puertas correderas tras. / Rear sliding doors / Portes couliss. arrière  (PUEVBC45ACCT)				

**Laterales no incluidos en el precio**  
**Side panels not included in price**  
**Joues non incluses dans le prix**





Serie / Series / Série **BARCELONA**

+Info: [www.infrico.com](http://www.infrico.com)

**Lineal VBC**  
VBC Linear assembly  
Assemblage lineaire VBC

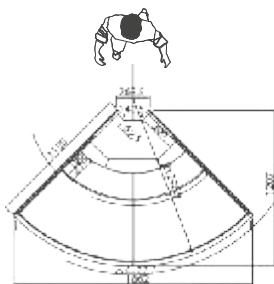

VBC 90 AA R/RI  
VBC 90 AA S/SI

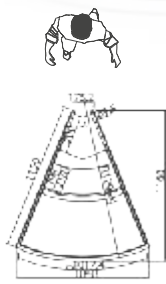

VBC 45 AA R/RI  
VBC 45 AA S/SI

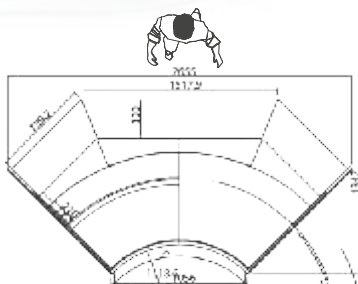

VBC 90 AC R/RI  
VBC 90 AC S/SI

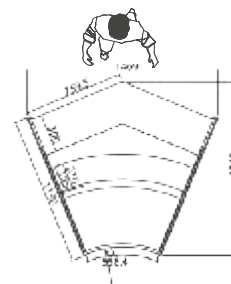

VBC 45 AC R/RI  
VBC 45 AC S/SI

**Laterales / Sides / Jous**

**VBC C/M/MHD: SÍ**

**Laterales / Sides / Jous**

**VBC 90/45: NO**

Izquierdo Left Gauche	Derecho Right Droite
-----------------------------	----------------------------



VBC 12 M

VBC 9 C

**Ext. Estándar / Standar / Standard**

Blanco/White/ Blanc	Ral 1001	Ral 1018
Ral 2003	Ral 3003	Ral 3020
Design 2108025	Ral 5015	Ral 4007
Ral 6002	Design 1107060	Design 3504035
Ral 9006	Ral 7016	Ral 8017

**Colores fuera de carta /  
Colors outside of letter /  
Couleurs spéciales, hors palette**

RAL		NO RAL	
Epoxi	Líquida/ Liquid/ Liquide	Epoxi	Líquida/ Liquid/ Liquide
[x unidad/x unit/x unité]		Consultar / Consultar / Consultar	
+10 días laborables / +10 work days / +10 jours ouvrés		Consultar / Consultar / Consultar	

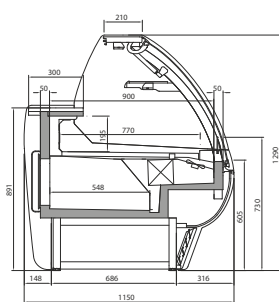

**VBC R/RI [con reserva]**  
[Whit storage][Avec réserve]

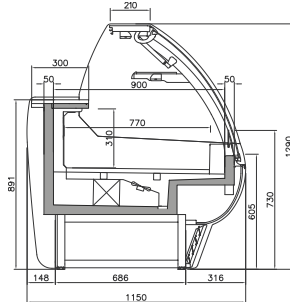



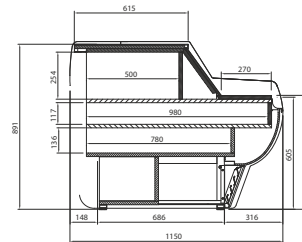











**VBC S/SI [Sin reserva]**  
[Whitout storage][Sans réserve]



**VBC**

# Vitrina expositora modular frío ventilado grupo incorporado / Refrigerated modular plugin display case / Vitrine présentation froid ventilé canalisable groupe incorporé

		CON RESERVA / WHIT STORAGE / AVEC RÉSERVE - RIU: Plano Inox / Stainless Steel exhibition plan / Plan d'exposition Inox						
MODELO MODELE MODÈLE								
Precio Price Prix	RUCP RIUCP							
		SIN RESERVA / WHITOUT STORAGE / SANS RÉSERVE - SIU: Plano Inox / Stainless Steel exhibition plan / Plan d'exposition Inox						
MODELO MODELE MODÈLE								
Precio Price Prix	SUCP SIUCP							
Medidas Mesures Mesures	[mm]	938 x 1150 x 1290 mm.	1250 x 1150 x 1290 mm.	1562 x 1150 x 1290 mm.	1875 x 1150 x 1290 mm.	2500 x 1150 x 1290 mm.	3125 x 1150 x 1290 mm.	3750 x 1150 x 1290 mm.
Temperatura Temperature Température	[°C]	0°C/+6°C						
Clase Climática Climatic class Classe climatique	[°C]	4 / 30°C						
Tensión/Frecuencia Electrical data Tension électrique		230V/1ph/50Hz						
Controlador Controller Régulateur		Digital						
Material Matériel Matériel	[EXT/INT]	Ext: acero plastificado / Plastified stainless steel / Acier plastifié Encimera / Worktop / Dessous: Inox Aisi 304 Plano exposición / Exhibition plan / Plan d'exposition: Acero plastif. / Plastif. Stainless steel/ Acier plastifié [Mod RU/SU] - Inox Aisi 304 [Mod. RIU/SIU]						
Aislamiento Isolation Isolation	[mm]	40kg/m <sup>3</sup> / Free CFC's / Zero ODP-GWP						
Capacidad Capacity Capacité	[L]	82	109	137	164	219	273	328
Superficie exposición Surface exhibition Surface d'exposition	[m <sup>2</sup> ]	0,92	1,23	1,53	1,84	2,45	3,06	3,68
Compresor Compressor Compresseur	[HP]	1/3	1/2	3/4	3/4	1+1/4	1+1/4	1+1/4
Estantes Shelving Étagères		1						
Costados (2) Sides (2) Joues (2)	[mm]	30+30						
Sistema de frío Cooling System Système de froid		Ventilado / Ventilated / Ventilé						
Desescarche Defrost Dégivrage		Automático / Automatic / Automatique						
Evaporación Evaporation Évaporation		Forzada / Forced / Ventilé						
Potencia Power Puissance	[W]	374	532	601	702	1177	1210	1234
Potencia frig. Cooling capacity Puissance Frig.	[W A -10°C]	-	-	-	-	-	-	-
Consumo Consumption Consommation	[kWh/ 24h]	4.7	6.4	7.2	8.4	12.7	14.5	16.3
Refrigerante Refrigerant Gaz		R-290						
Opcional Optional Options		Puertas correderas traseras / Rear sliding doors / Portes coulissantes arrière						
		[PUEV9CT]	[PUEV12CT]	[PUEV15CT]	[PUEV18CT]	[PUEV25CT]	[PUEV31CT]	[PUEV37CT]
		Cortinas traseras nocturnas / Night curtains / Rideaux de nuit						
		[CCNV9]	[CCNV12]	[CCNV15]	[CCNV18]	[CCNV25]	[CCNV31]	[CCNV37]

Laterales no incluidos en el precio  
Side panels not included in price  
Joues non incluses dans le prix

Serie / Series / Série **BARCELONA**

+Info: [www.infrico.com](http://www.infrico.com)

VBC 12 RUCP



VBC 12 SUCP



**Laterales / Sides / Joues**

NO	
Izquierdo Left Gauche	Derecho Right Droite

**Ext. Estándar / Standar / Standard**

Blanco/White/ Blanc	Ral 1001	Ral 1018
Ral 2003	Ral 3003	Ral 3020
Design 2108025	Ral 5015	Ral 4007
Ral 6002	Design 1107060	Design 3504035
Ral 9006	Ral 7016	Ral 8017

**Colores fuera de carta /  
Colors outside of letter /  
Couleurs spéciales, hors palette**

RAL		NO RAL	
Epoxi	Líquida/ Liquid/ Liquide	Epoxi	Líquida/ Liquid/ Liquide
[x unidad/x unit/x unité]		Consultar / Consultar / Consulter	
+10 días laborables / +10 work days / +10 jours ouvrés		Consultar / Consultar / Consulter	

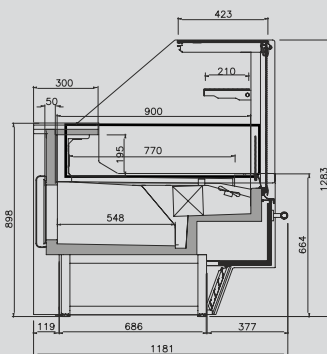

**VBC RU (con reserva)  
[Whit storage]  
[Avec réserve]**

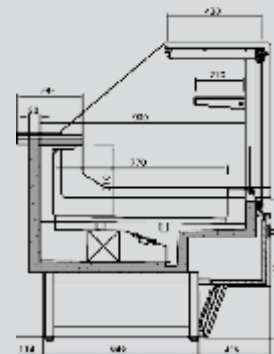









**VBC SU (Sin reserva)  
[Whitout storage]  
[Sans réserve]**



**Vitrina expositora modular frío ventilado grupo incorporado /**  
**Refrigerated modular plugin display case /**  
**Vitrine présentation froid ventilé canalisable groupe incorporé**

**Mueble caja /**  
**Counter case /**  
**Meuble de comptoir**

		CON RESERVA / WHIT STORAGE / AVEC RÉSERVE RIU: Plano Inox / Stainless Steel exhibition plan / Plan d'exposition Inox		MUEBLE CAJA / COUNTER CASE / MEUBLE DE COMPTOIR			
MODELO MODELE MODÈLE							
		VBC90 A RUCP/RIUCP	VBC90 C RUCP/RIUCP	VBC 9 CP	VBC 12 MP	VBC 15 MP	VBC 12 MHDP
Precio Price Prix	RUCP RIUCP						
MODELO MODELE MODÈLE		SIN RESERVA / WHITOUT STORAGE / SANS RÉSERVE SIU: Plano Inox / Stainless Steel exhibition plan / Plan d'exposition Inox		-	-	-	-
				-	-	-	-
		VBC90 A SUCP/SIUCP	VBC90 C SUCP/SIUCP	-	-	-	-
Precio Price Prix	SUCP SIUCP						
Medidas Measures Mesures	[mm]	1887 x 1150 x 1290 mm.	1470 x 1150 x 1290 mm.	938 x 1150 x 906 mm.	1250 x 1150 x 906 mm.	1562 x 1150 x 906 mm.	1250 x 1150 x 906 mm.
Temperatura Temperature Température	[°C]	0°C/+6°C		-	-	-	-
Clase Climática Climatic class Classe climatique	[°C]	4 / 30°C		-	-	-	-
Tensión/Frecuencia Electrical data Tension électrique		230V/1ph/50Hz		-	-	-	-
Controlador Controller Régulateur		Digital		-	-	-	-
Material Matériel	[EXT/INT]	Ext: acero plastificado / Plastified stainless steel / Acier plastifié Encimera / Worktop / Dessous: Inox Aisi 304 Plano exposición / Exhibition plan / Plan d'exposition: Acero plastif. / Plastif. Stainless steel/ Acier plastifié [Mod RU/SU] - Inox Aisi 304 [Mod. RIU/SIU]					
Aislamiento Isolation Isolation	[mm]	40kg/m <sup>3</sup> / Free CFC's / Zero ODP-GWP		-	-	-	-
Capacidad Capacity Capacité	[L]	1,09	1,43	-	-	-	-
Superficie exposición Surface exhibition Surface d'exposition	[m <sup>2</sup> ]	-	-	0,55	0,74	0,92	-
Compresor Compressor Compresseur	[HP]	5/8	3/4	-	-	-	-
Estantes Shelving Étagères		-					
Costados (2) Sides (2) Joues (2)	[mm]	30+30					
Sistema de frío Cooling System Système de froid		Ventilado / Ventilated / Ventilé		-	-	-	-
Desescarche Defrost Dégivrage		Automático / Automatic / Automatique		-	-	-	-
Evaporación Evaporation Évaporation		Forzada / Forced / Ventilé		-	-	-	-
Potencia Power Puissance	[W]	1025	1110	-	-	-	-
Potencia frig. Cooling capacity Puissance Frig.	[W A -10°C]	-	-	-	-	-	-
Consumo Consumption Consommation	[kWh/ 24h]	14,4	15,5	-	-	-	-
Refrigerante Refrigerant Gaz		R-290		-	-	-	-
Opcional Optional Options		Puertas correderas tras. / Rear sliding doors / Portes couliss. arrière  (PUEVBC90ARCT)	Puertas correderas tras. / Rear sliding doors / Portes couliss. arrière  (PUEVBC90CRCT)	-	-	-	-

**Laterales no incluidos en el precio**  
**Side panels not included in price**  
**Joues non incluses dans le prix**

Serie / Series / Série **BARCELONA**

+Info: [www.infrico.com](http://www.infrico.com)



**Lineal VBC**  
VBC Linear assembly  
Assemblage lineaire VBC



**Laterales / Sides / Jous**

**VBC CP/MP/MHDP: SÍ**

**Laterales / Sides / Jous**

**VBC 90: NO**

Izquierdo Left Gauche	Derecho Right Droite
-----------------------------	----------------------------

**Ext. Estándar / Standar / Standard**

Blanco/White/ Blanc	Ral 1001	Ral 1018
Ral 2003	Ral 3003	Ral 3020
Design 2108025	Ral 5015	Ral 4007
Ral 6002	Design 1107060	Design 3504035
Ral 9006	Ral 7016	Ral 8017

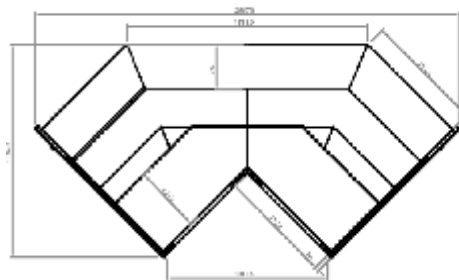

**VBC 90 AC RUCP/SUCP**

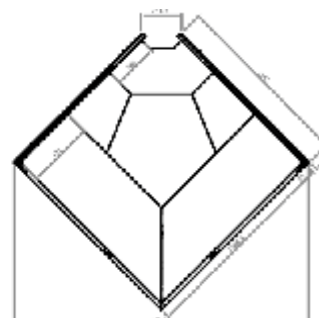

**VBC 90 AA RUCP/SUCP**

**Colores fuera de carta /  
Colors outside of letter /  
Couleurs spéciales, hors palette**

RAL		NO RAL	
Epoxi	Líquida/ Liquid/ Liquide	Epoxi	Líquida/ Liquid/ Liquide
[x unidad/x unit/x unité]		Consultar / Consultar / Consulter	
+10 días laborables / +10 work days / +10 jours ouvrés		Consultar / Consultar / Consulter	

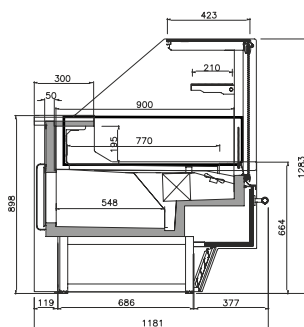

**VBC RUCP (con reserva)**  
[Whit storage]  
[Avec réserve]

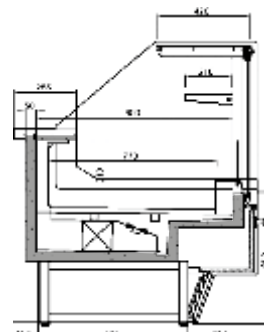



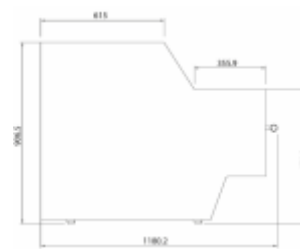











**VBC SUCP (Sin reserva)**  
[Whitout storage]  
[Sans réserve]



**VBC P**

# Vitrina expositora modular frío ventilado grupo remoto / Refrigerated modular display remote case / Vitrine présentation froid ventilé canalisable groupe à distance

		CON RESERVA / WHIT STORAGE / AVEC RÉSERVE - RI: Plano Inox / Stainless Steel exhibition plan / Plan d'exposition Inox						
MODELO MODELE MODÈLE								
Precio Price Prix	RCP RICP							
		SIN RESERVA / WHITOUT STORAGE / SANS RÉSERVE - SIU: Plano Inox / Stainless Steel exhibition plan / Plan d'exposition Inox						
MODELO MODELE MODÈLE								
Precio Price Prix	SCP SICP							
Medidas Mesures Mesures	[mm]	938 x 1150 x 1290 mm.	1250 x 1150 x 1290 mm.	1562 x 1150 x 1290 mm.	1875 x 1150 x 1290 mm.	2500 x 1150 x 1290 mm.	3125 x 1150 x 1290 mm.	3750 x 1150 x 1290 mm.
Temperatura Temperature Température	[°C]	0°C/+6°C						
Clase Climática Climatic class Classe climatique	[°C]	4 / 30°C						
Tensión/Frecuencia Electrical data Tension électrique		230V/1ph/50Hz						
Controlador Controller Régulateur		Digital						
Material Materiel Matériel	[EXT/INT]	Ext: acero plastificado / Plastified stainless steel / Acier plastifié Encimera / Worktop / Dessous: Inox Aisi 304 Plano exposición / Exhibition plan / Plan d'exposition: Acero plastif./Plastif. Stainless steel/ Acier plastifié (Mod R/S) - Inox Aisi 304 (Mod. S/SI)						
Aislamiento Isolation Isolation	[mm]	40kg/m <sup>3</sup> / Free CFC's / Zero ODP-GWP						
Capacidad Capacity Capacité	[L]	82	109	137	164	219	273	328
Superficie exposición Surface exhibition Surface d'exposition	[m <sup>2</sup> ]	0,92	1,23	1,53	1,84	2,45	3,06	3,68
Compresor Compressor Compresseur	[HP]	-	-	-	-	-	-	-
Estantes Shelving Étagères		1						
Costados (2) Sides (2) Joues (2)	[mm]	30+30						
Sistema de frío Cooling System Système de froid		Ventilado / Ventilated / Ventilé						
Desescarche Defrost Dégivrage		Automático / Automatic / Automatique						
Evaporación Evaporation Évaporation		Forzada / Forced / Ventilé						
Potencia Power Puissance	[W]	-	-	-	-	-	-	-
Potencia frig. Cooling capacity Puissance Frig.	[W A -10°C]	656	874	1092	1315	1748	2184	2621
Consumo Consumption Consommation	[kWh/ 24h]	-	-	-	-	-	-	-
Refrigerante Refrigerant Gaz		R-290						
Opcional Optional Options		Puertas correderas traseras / Rear sliding doors / Portes coulissantes arrière						
		[PUEV9CT]	[PUEV12CT]	[PUEV15CT]	[PUEV18CT]	[PUEV25CT]	[PUEV31CT]	[PUEV37CT]
		Cortinas traseras nocturnas / Night curtains / Rideaux de nuit						
		[CCNV9]	[CCNV12]	[CCNV15]	[CCNV18]	[CCNV25]	[CCNV31]	[CCNV37]

Laterales no incluidos en el precio  
Side panels not included in price  
Joues non incluses dans le prix

Serie / Series / Série **BARCELONA**

+Info: [www.infrico.com](http://www.infrico.com)

VBC 12 SCP



Laterales / Sides / Joues

NO	
Izquierdo Left Gauche	Derecho Right Droite

Ext. Estándar / Standar / Standard

Blanco/White/ Blanc	Ral 1001	Ral 1018
Ral 2003	Ral 3003	Ral 3020
Design 2108025	Ral 5015	Ral 4007
Ral 6002	Design 1107060	Design 3504035
Ral 9006	Ral 7016	Ral 8017

VBC 12 RCP



Colores fuera de carta /  
Colors outside of letter /  
Couleurs spéciales, hors palette

RAL		NO RAL	
Epoxi	Líquida/ Liquid/ Liquide	Epoxi	Líquida/ Liquid/ Liquide
[x unidad/x unit/x unité]		Consultar / Consulter / Consulter	
+10 días laborables / +10 work days / +10 jours ouvrés		Consultar / Consulter / Consulter	

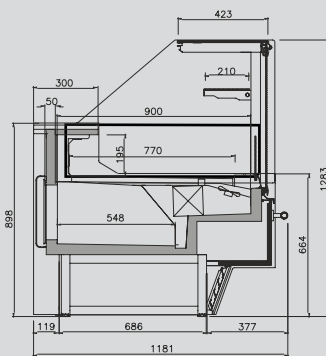

VBC R [con reserva]  
[Whit storage]  
[Avec réserve]

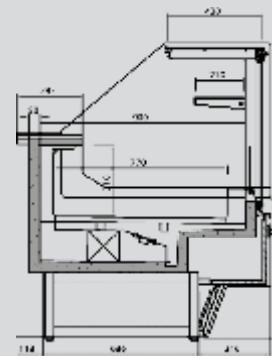









VBC S [Sin reserva]  
[Whitout storage]  
[Sans réserve]



**Vitrina expositora modular frío ventilado grupo remoto /**  
**Refrigerated modular display remote case /**  
**Vitrine présentation froid ventilé canalisable groupe à distance**

**Mueble caja /**  
**Counter case /**  
**Meuble de comptoir**

		CON RESERVA / WHIT STORAGE / AVEC RÉSERVE Rt: Plano Inox / Stainless Steel exhibition plan / Plan d'exposition Inox		MUEBLE CAJA / COUNTER CASE / MEUBLE DE COMPTOIR			
MODELO MODELE MODÈLE							
Precio Price Prix		RCP	IRCP				
MODELO MODELE MODÈLE		SIN RESERVA / WHITOUT STORAGE / SANS RÉSERVE St: Plano Inox / Stainless Steel exhibition plan / Plan d'exposition Inox					
				-	-	-	-
Precio Price Prix		SCP	ISCP				
Medidas Measures Mesures		[mm]	[mm]	[mm]	[mm]	[mm]	[mm]
Temperatura Temperature Température		0°C/+6°C					
Clase Climática Climatic class Classe climatique		4 / 30°C					
Tensión/Frecuencia Electrical data Tension électrique		230V/1ph/50Hz					
Controlador Controller Régulateur		Digital					
Material Materiel Matériel		Ext: acero plastificado / Plastified stainless steel / Acier plastifié Encimera / Worktop / Dessous: Inox Aisi 304 Plano exposición / Exhibition plan / Plan d'exposition: Acero plastif./ Plastif. Stainless steel/ Acier plastifié [Mod RCP/SCP] - Inox Aisi 304 [Mod. I]					
Aislamiento Isolation Isolation		40kg/m <sup>3</sup> / Free CFC's / Zero ODP-GWP					
Capacidad Capacity Capacité		[L]	[L]				
Superficie exposición Surface exhibition Surface d'exposition		[m <sup>2</sup> ]	[m <sup>2</sup> ]	[m <sup>2</sup> ]	[m <sup>2</sup> ]	[m <sup>2</sup> ]	[m <sup>2</sup> ]
Compresor Compressor Compresseur		[HP]	[HP]				
Estantes Shelving Étagères		-					
Costados (2) Sides (2) Joues (2)		30+30					
Sistema de frío Cooling System Système de froid		Ventilado / Ventilated / Ventilé					
Desescarche Defrost Dégivrage		Automático / Automatic / Automatique					
Evaporación Evaporation Évaporation		Forzada / Forced / Ventilé					
Potencia Power Puissance		[W]	[W]				
Potencia frig. Cooling capacity Puissance Frig.		[W A -10°C]	[W A -10°C]				
Consumo Consumption Consommation		[kWh/ 24h]	[kWh/ 24h]				
Refrigerante Refrigerant Gaz		R-290					
Opcional Optional Options		Puertas correderas tras. / Rear sliding doors / Portes couliss. arrière  (PUEVBC90ARCT)		Puertas correderas tras. / Rear sliding doors / Portes couliss. arrière  (PUEVBC90CRCT)			

**Laterales no incluidos en el precio**  
**Side panels not included in price**  
**Joues non incluses dans le prix**





Serie / Series / Série **BARCELONA**

+Info: [www.infrico.com](http://www.infrico.com)

**Lineal VBC**  
VBC Linear assembly  
Assemblage lineaire VBC



**Laterales / Sides / Joues**

**VBC CP/MP/MHDP: SÍ**

**Laterales / Sides / Joues**

**VBC90 AA-AC: NO**

Izquierdo Left Gauche	Derecho Right Droite
-----------------------------	----------------------------

**Ext. Estándar / Standar / Standard**

Blanco/White/ Blanc	Ral 1001	Ral 1018
Ral 2003	Ral 3003	Ral 3020
Design 2108025	Ral 5015	Ral 4007
Ral 6002	Design 1107060	Design 3504035
Ral 9006	Ral 7016	Ral 8017

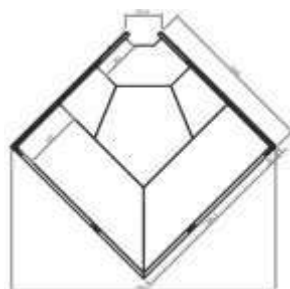

VBC 90 AA RCP/SCP

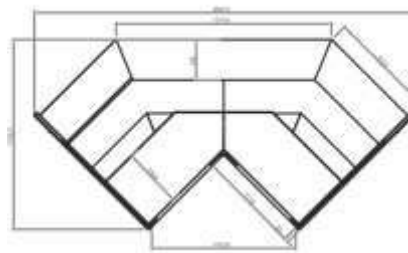

VBC 90 AC RCP/SCP

**Colores fuera de carta /  
Colors outside of letter /  
Couleurs spéciales, hors palette**

RAL		NO RAL	
Epoxi	Líquida/ Liquid/ Liquide	Epoxi	Líquida/ Liquid/ Liquide
[x unidad/x unit/x unité]		Consultar / Consulter / Consulter	
+10 días laborables / +10 work days / +10 jours ouvrés		Consultar / Consulter / Consulter	

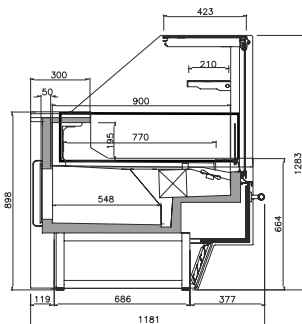

**VBC RCP [con reserva]**  
[Whit storage]  
[Avec réserve]

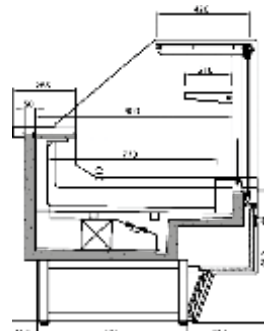

**VBC SCP [Sin reserva]**  
[Whitout storage]  
[Sans réserve]



**VBC P**

# Vitrina expositora modular frío ventilado grupo incorporado / Refrigerated modular plugin display case / Vitrine présentation froid ventilé canalisable groupe incorporé

**CURVA / CURVED / BOMBÉE - SIU: Plano Inox / Stainless Steel exhibition plan / Plan d'exposition Inox**

MODELO  
MODELE  
MODÈLE



VBC 9 SUCB/SIUCB



VBC 12 SUCB/SIUCB



VBC 15 SUCB/SIUCB

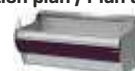

VBC 18 SUCB/SIUCB



VBC 25 SUCB/SIUCB

Precio Price Prix	SUCB SIUCB					
-------------------------	---------------	--	--	--	--	--

**RECTA / FLAT / DROITE - SIU: Plano Inox / Stainless Steel exhibition plan / Plan d'exposition Inox**

MODELO  
MODELE  
MODÈLE



VBC 9 SUCB CP/SIUCB CP



VBC 12 SUCB CP/SIUCB CP



VBC 15 SUCB CP/SIUCB CP



VBC 18 SUCB CP/SIUCB CP



VBC 25 SUCB CP/SIUCB CP

Precio Price Prix	SUCB CP SIUCB CP					
-------------------------	---------------------	--	--	--	--	--

Medidas Measures Mesures	(mm)	938 x 1181 x 897 mm.	1250 x 1181 x 897 mm.	1562 x 1181 x 897 mm.	1875 x 1181 x 897 mm.	2500 x 1181 x 897 mm.
--------------------------------	------	----------------------------	-----------------------------	-----------------------------	-----------------------------	-----------------------------

Temperatura Temperature Température	(°C)	0°C/+6°C				
---	------	----------	--	--	--	--

Clase Climática Climatic class Classe climatique	(°C)	4 / 30°C				
--	------	----------	--	--	--	--

Tensión/Frecuencia Electrical data Tension électrique		230V/1ph/50Hz				
---	--	---------------	--	--	--	--

Controlador Controller Régulateur		Digital				
---	--	---------	--	--	--	--

Material Matériel	[EXT/INT]	Ext: acero plastificado / Plastified stainless steel / Acier plastifié Encimera / Worktop / Dessous: Inox Aisi 304 Plano exposición / Exhibition plan / Plan d'exposition: Acero plastif./ Plastif. Stainless steel/ Acier plastifié [Mod SUCB/SUCP] - Inox Aisi 304 [Mod. I]				
----------------------	-----------	---	--	--	--	--

Aislamiento Isolation Isolation	(mm)	40kg/m <sup>3</sup> / Free CFC's / Zero ODP-GWP				
---------------------------------------	------	---	--	--	--	--

Capacidad Capacity Capacité	(L)	108	144	180	217	289
-----------------------------------	-----	-----	-----	-----	-----	-----

Superficie exposición Surface exhibition Surface d'exposition	(m <sup>2</sup> )	0,72	0,96	1,20	1,44	1,93
---	-------------------	------	------	------	------	------

Compresor Compressor Compresseur	(HP)	1/3	1/2	3/4	3/4	1+1/4
--	------	-----	-----	-----	-----	-------

Estantes Shelving Étagères		-				
----------------------------------	--	---	--	--	--	--

Costados (2) Sides (2) Joues (2)	(mm)	30+30				
--	------	-------	--	--	--	--

Sistema de frío Cooling System Système de froid		Ventilado / Ventilated / Ventilé				
---	--	----------------------------------	--	--	--	--

Desescarche Defrost Dégivrage		Automático / Automatic / Automatique				
-------------------------------------	--	--------------------------------------	--	--	--	--

Evaporación Evaporation Évaporation		Forzada / Forced / Ventilé				
---	--	----------------------------	--	--	--	--

Potencia Power Puissance	(W)	593	701	816	823	1207
--------------------------------	-----	-----	-----	-----	-----	------

Potencia frig. Cooling capacity Puissance Frig.	(W A -10°C)	-	-	-	-	-
---	----------------	---	---	---	---	---

Consumo Consumption Consommation	(kWh/ 24h)	7,10	8,04	9,80	10,1	14,5
--	---------------	------	------	------	------	------

Refrigerante Refrigerant Gaz		R-290				
------------------------------------	--	-------	--	--	--	--

Opcional Optional Options		-				
---------------------------------	--	---	--	--	--	--

**Laterales no incluidos en el precio  
Side panels not included in price  
Joues non incluses dans le prix**

Serie / Series / Série **BARCELONA**

+Info: [www.infrico.com](http://www.infrico.com)

VBC 15 SUCB



Laterales / Sides / Joues **SUCB**

NO	
Izquierdo Left Gauche	Derecho Right Droite

Ext. Estándar / Standar / Standard

Blanco/White/ Blanc	Ral 1001	Ral 1018
Ral 2003	Ral 3003	Ral 3020
Design 2108025	Ral 5015	Ral 4007
Ral 6002	Design 1107060	Design 3504035
Ral 9006	Ral 7016	Ral 8017



Cortina nocturna de serie  
Standard night curtain  
Rideau de nuit de série

Colores fuera de carta /  
Colors outside of letter /  
Couleurs spéciales, hors palette

RAL		NO RAL	
Epoxi	Líquida/ Liquid/ Liquide	Epoxi	Líquida/ Liquid/ Liquide
[x unidad/x unit/x unité]		Consultar / Consultar / Consulter	
+10 días laborables / +10 work days / +10 jours ouvrés		Consultar / Consultar / Consulter	

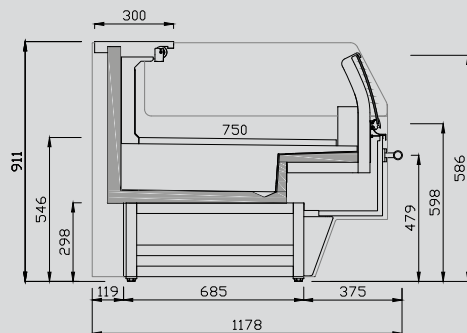



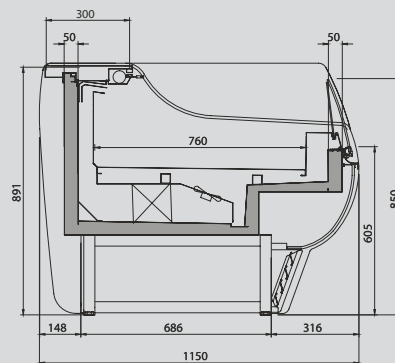







VBC SUCB CP



VBC SUCB

# Vitrina expositora modular frío ventilado grupo remoto / Refrigerated modular display remote case / Vitrine présentation froid ventilé canalisable groupe à distance

CURVA / CURVED / BOMBÉE - SI: Plano Inox / Stainless Steel exhibition plan / Plan d'exposition Inox

MODELO MODELE MODÈLE						
Precio Price Prix	SCB					
	SICB					
RECTA / FLAT / DROITE - SI: Plano Inox / Stainless Steel exhibition plan / Plan d'exposition Inox						
MODELO MODELE MODÈLE						
Precio Price Prix	SCB CP					
	SICB CP					
Medidas Measures Mesures	(mm)	938 x 1181 x 897 mm.	1250 x 1181 x 897 mm.	1562 x 1181 x 897 mm.	1875 x 1181 x 897 mm.	2500 x 1181 x 897 mm.
Temperatura Temperature Température	(°C)	0°C/+6°C				
Clase Climática Climatic class Classe climatique	(°C)	4 / 30°C				
Tensión/Frecuencia Electrical data Tension électrique		230V/1ph/50Hz				
Controlador Controller Régulateur		Digital				
Material Matériel	[EXT/INT]	Ext: acero plastificado / Plastified stainless steel / Acier plastifié Encimera / Worktop / Dessous: Inox Aisi 304 Plano exposición / Exhibition plan / Plan d'exposition: Acero plastif./ Plastif. Stainless steel/ Acier plastifié [Mod SCB/SCP] - Inox Aisi 304 [Mod. I]				
Aislamiento Isolation Isolation	(mm)	40kg/m <sup>3</sup> / Free CFC's / Zero ODP-GWP				
Capacidad Capacity Capacité	(L)	108	144	180	217	289
Superficie exposición Surface exhibition Surface d'exposition	(m <sup>2</sup> )	0,72	0,96	1,20	1,44	1,93
Compresor Compressor Compresseur	(HP)	-	-	-	-	-
Estantes Shelving Étagères		-				
Costados (2) Sides (2) Joues (2)	(mm)	30+30				
Sistema de frío Cooling System Système de froid		Ventilado / Ventilated / Ventilé				
Desescarche Defrost Dégivrage		Automático / Automatic / Automatique				
Evaporación Evaporation Évaporation		Forzada / Forced / Ventilé				
Potencia Power Puissance	(W)	-	-	-	-	-
Potencia frig. Cooling capacity Puissance Frig.	(W A -10°C)	817	1096	1315	1506	2009
Consumo Consumption Consommation	(kWh/ 24h)	-	-	-	-	-
Refrigerante Refrigerant Gaz		R-290				
Opcional Optional Options		-				

Laterales no incluidos en el precio  
Side panels not included in price  
Joues non incluses dans le prix

Serie / Series / Série **BARCELONA**

+Info: [www.infrico.com](http://www.infrico.com)

VBC 15 SCB CP



Laterales / Sides / Joues **SCB CP**

NO	
Izquierdo Left Gauche	Derecho Right Droite

Ext. Estándar / Standar / Standard

Blanco/White/ Blanc	Ral 1001	Ral 1018
Ral 2003	Ral 3003	Ral 3020
Design 2108025	Ral 5015	Ral 4007
Ral 6002	Design 1107060	Design 3504035
Ral 9006	Ral 7016	Ral 8017



Cortina nocturna de serie  
Standard night curtain  
Rideau de nuit de série

Colores fuera de carta /  
Colors outside of letter /  
Couleurs spéciales, hors palette

RAL		NO RAL	
Epoxi	Líquida/ Liquid/ Liquide	Epoxi	Líquida/ Liquid/ Liquide
[x unidad/x unit/x unité]		Consultar / Consulter / Consulter	
+10 días laborables / +10 work days / +10 jours ouvrés		Consultar / Consulter / Consulter	

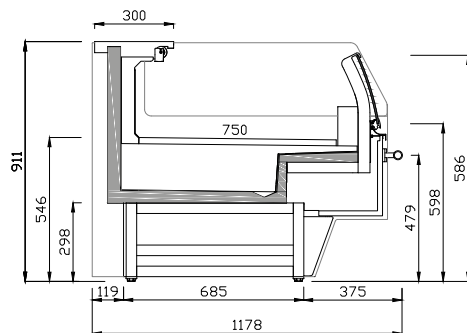

VBC SCB CP

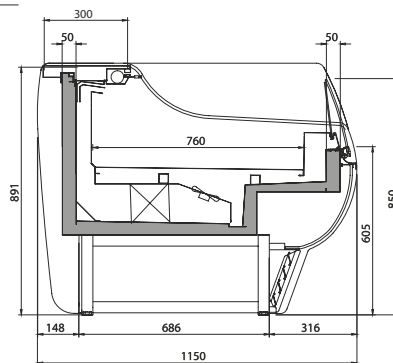

VBC SCB



















9

+Info: [www.infrico.com](http://www.infrico.com)



# Vitrina Experience grupo incorporado / Plug in refrigerated display case Experience / Vitrine Experience groupe incorporé

CRISTAL RECTO / FLAT GLASS / VITRE DROITE							
MODELO MODELE MODÈLE							
Precio Price Prix						<b>NEW</b>	<b>NEW</b>
MOD.	VEX09 IU CP	VEX12 IU CP	VEX15 IU CP	VEX18 IU CP	VEX25 IU CP	VEX31 IU CP	VEX37 IU CP
Precio PLANO INOX Price STAINL. STEEL SURF. Prix PLAN INOX						<b>NEW</b>	<b>NEW</b>
CRISTAL CURVO / CURVED GLASS / VITRE BOMBÉE							
MODELO MODELE MODÈLE							
Precio Price Prix						<b>NEW</b>	<b>NEW</b>
MOD.	VEX09 IU	VEX12 IU	VEX15 IU	VEX18 IU	VEX25 IU	VEX31 IU	VEX37 IU
Precio PLANO INOX Price STAINL. STEEL SURF. Prix PLAN INOX						<b>NEW</b>	<b>NEW</b>
Medidas Mesures [mm]	938 x 1295 x 1220 mm.	1250 x 1295 x 1220 mm.	1562 x 1295 x 1220 mm.	1875 x 1295 x 1220 mm.	2500 x 1295 x 1220 mm.	3125 x 1295 x 1220 mm.	3750 x 1295 x 1220 mm.
Temperatura Temperature Température [°C]	-1°C/+5°C						
Clase Climática Climatic class Classe climatique [°C]	4 / 30°C						
Tensión/Frecuencia Electrical data Tension électrique	230V/1ph/50Hz						
Controlador Controller Régulateur	Digital						
Material Matériel [EXT/INT]	Ext + Costados/Sides/Joues: acero plastificado / Plastified steel / Acier plastifié Encimera / Worktop / Dessous: Inox Aisi 304 Plano exposición / Exhibition plan / Plan d'exposition: Acero plastif./Plastif. steel/ Acier plastifié [Mod U/UCP] - Inox Aisi 304 [Mod. I]						
Aislamiento Isolation Isolation [mm]	40kg/m³ / Free CFC's / Zero ODP-GWP						
Capacidad Capacity Capacité [L]	169	225	281	338	450	563	675
Superficie exposición Surface exhibition Surface d'exposition [m²]	0,84	1,13	1,41	1,69	2,25	2,81	3,40
Compresor Compressor Compresseur [HP]	1/3	1/2	3/4	3/4	1 1/4	1 1/4	1 1/4
Costados (2) Sides (2) Joues (2) [mm]	30 + 30						
Sistema de frío Cooling System Système de froid	Ventilado / Ventilated / Ventilé						
Desescarche Defrost Dégivrage	Automático / Automatic / Automatique						
Evaporación Evaporation Evaporation	Forzada / Forced / Ventilé						
Potencia Power Puissance [W]	484	650	714	810	1264	2461	2493
Potencia frig. Cooling capacity Puissance Frig. [W A -10°C]	-						
Consumo Consumption Consommation [kWh/ 24h]	6,9	9,4	10,3	11,7	18,2	35,4	35,9
Refrigerante Refrigerant Gaz	R-290						
Opcional Optional Options	Puertas correderas traseras / Rear sliding doors / Portes coulissantes arrière						
	<b>R</b>	<b>P</b>	<b>R</b>	<b>P</b>	<b>R</b>	<b>P</b>	<b>R</b>
	Doble Plano / Double surface / Double plan						
	Doble plano Inox / Stainless steel double surface / Double plan Inox						
	Control de Condensación SSC / SCC Condensing Control / Contrôle de la Condensation SCC						

R: CRISTAL CURVO / CURVED GLASS / VITRE BOMBÉE  
P: CRISTAL RECTO / FLAT GLASS / VITRE DROITE

Laterales no incluidos en el precio  
Side panels not included in price  
Joues non incluses dans le prix



Serie / Series / Série **VEX - EXPERIENCE**

+Info: [www.infrico.com](http://www.infrico.com)

VEX37UCP



Laterales / Sides / Joutes

NO	
Izquierdo Left Gauche	Derecho Right Droite



VEX37U

Ext. Estándar / Standar / Standard

Blanco/White/ Blanc	Ral 1015	Ral 1018
Ral 2003	Ral 3003	Ral 3020
Ral 5015	Ral 5017	Ral 5011
Ral 6002	Ral 6018	Ral 6019
Ral 7035	Ral 7037	Ral 7042
Ral 7016	Negro/Black/ Noir	Roble natural

Colores fuera de carta /  
Colors outside of letter /  
Couleurs spéciales, hors palette

RAL		NO RAL	
Epoxi	Líquida/ Liquid/ Liquide	Epoxi	Líquida/ Liquid/ Liquide
[x unidad/x unit/x unité]		Consultar / Consultar / Consulter	
+10 días laborables / +10 work days / +10 jours ouvrés		Consultar / Consultar / Consulter	

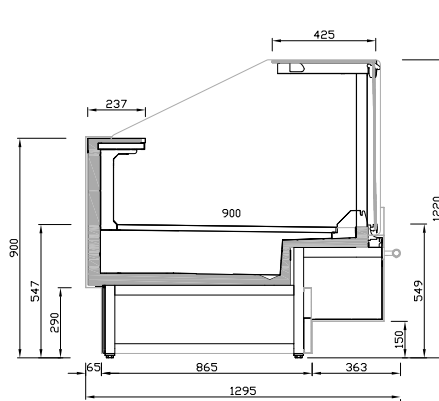



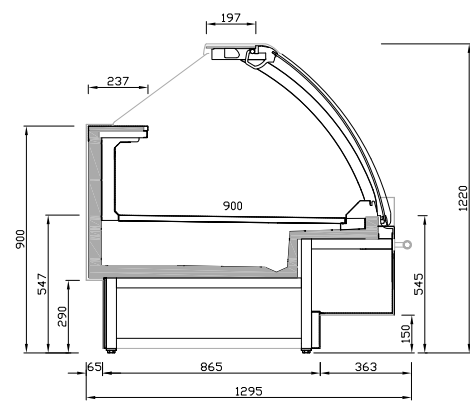

VEX UCP



VEX U



# Vitrina Experience grupo incorporado / Plug in refrigerated display case Experience / Vitrine Experience groupe incorporé

MODELO MODELE MODÈLE					
	<b>VEX09 U CB</b>	<b>VEX12 U CB</b>	<b>VEX15 U CB</b>	<b>VEX18 U CB</b>	<b>VEX25 U CB</b>
Precio Price Prix					
<b>MOD.</b>	<b>VEX09 IU CB</b>	<b>VEX12 IU CB</b>	<b>VEX15 IU CB</b>	<b>VEX18 IU CB</b>	<b>VEX25 IU CB</b>
<b>Precio PLANO INOX</b> Price STAINL.STEEL SURF. Prix PLAN INOX					
<b>Medidas</b> Measures (mm) Mesures	938 x 1225 x 875 mm.	1250 x 1225 x 875 mm.	1562 x 1225 x 875 mm.	1875 x 1225 x 875 mm.	2500 x 1225 x 875 mm.
<b>Temperatura</b> Temperature (°C) Température	<b>-1°C/+7°C</b>				
<b>Clase Climática</b> Climatic class (°C) Classe climatique	4 / 30°C				
<b>Tensión/Frecuencia</b> Electrical data Tension électrique	230V/1ph/50Hz				
<b>Controlador</b> Controller Régulateur	Digital				
<b>Material</b> Matériel (EXT/INT)	Ext + Costados/Sides/Joues: acero plastificado / Plastified steel / Acier plastifié Encimera / Worktop / Dessous: Inox Aisi 304 Plano exposición / Exhibition plan / Plan d'exposition: Acero plastif./ Plastif. steel/ Acier plastifié [Mod U/UCP] - Inox Aisi 304 [Mod. I]				
<b>Aislamiento</b> Isolation (mm) Isolation	40kg/m <sup>3</sup> / Free CFC's / Zero ODP-GWP				
<b>Capacidad</b> Capacity (L) Capacité	169	225	281	338	450
<b>Superficie exposición</b> Surface exhibition (m <sup>2</sup> ) Surface d'exposition	0,84	1,13	1,41	1,69	2,25
<b>Compresor</b> Compressor (HP) Compresseur	3/4	3/4	1	1	1 1/4
<b>Costados [2]</b> Sides [2] Joues [2] (mm)	30 + 30				
<b>Sistema de frío</b> Cooling System Système de froid	Ventilado / Ventilated / Ventilé				
<b>Desescarche</b> Defrost Dégivrage	Automático / Automatic / Automatique				
<b>Evaporación</b> Evaporation Évaporation	Forzada / Forced / Ventilé				
<b>Potencia</b> Power (W) Puissance	503	590	682	780	1005
<b>Potencia frig.</b> Cooling capacity (W A -10°C) Puissance Frig.	-				
<b>Consumo</b> Consumption (kWh/24h) Consommation	6,64	7,80	9,10	9,80	13,3
<b>Refrigerante</b> Refrigerant Gaz	<b>R-290</b>				
<b>Opcional</b> Optional Options	<b>Doble Plano /</b> Double surface / Double plan	<b>Doble Plano /</b> Double surface / Double plan	<b>Doble Plano /</b> Double surface / Double plan	<b>Doble Plano /</b> Double surface / Double plan	<b>Doble Plano /</b> Double surface / Double plan
	<b>Doble plano Inox /</b> Stainl. steel double surface / Double plan Inox	<b>Doble plano Inox /</b> Stainl. steel double surface / Double plan Inox	<b>Doble plano Inox /</b> Stainl. steel double surface / Double plan Inox	<b>Doble plano Inox /</b> Stainl. steel double surface / Double plan Inox	<b>Doble plano Inox /</b> Stainl. steel double surface / Double plan Inox

**Laterales no incluidos en el precio**  
Side panels not included in price  
Joues non incluses dans le prix

Serie / Series / Série **VEX - EXPERIENCE**

+Info: [www.infrico.com](http://www.infrico.com)

VEX25UCB



**Laterales / Sides / Jous**

NO	
Izquierdo Left Gauche	Derecho Right Droite



VEX25UCB

**Ext. Estándar / Standar / Standard**

Blanco/White/ Blanc	Ral 1015	Ral 1018
Ral 2003	Ral 3003	Ral 3020
Ral 5015	Ral 5017	Ral 5011
Ral 6002	Ral 6018	Ral 6019
Ral 7035	Ral 7037	Ral 7042
Ral 7016	Negro/Black/ Noir	Roble natural

**Colores fuera de carta /  
Colors outside of letter /  
Couleurs spéciales, hors palette**



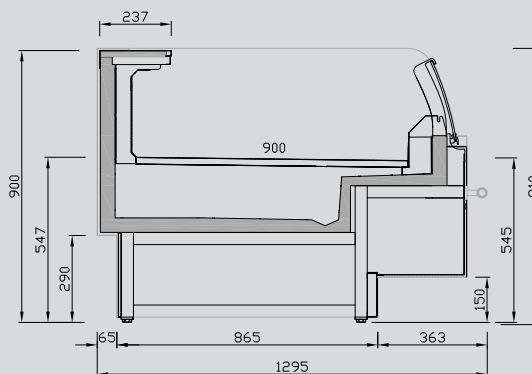

RAL		NO RAL	
Epoxi	Líquida/ Liquid/ Liquide	Epoxi	Líquida/ Liquid/ Liquide
[x unidad/x unit/x unité]		Consultar / Consultar / Consulter	
+10 días laborables / +10 work days / +10 jours ouvrés		Consultar / Consultar / Consulter	



VEX UCB



# Vitrina Experience grupo incorporado / Plug in refrigerated display case Experience / Vitrine Experience groupe incorporé

MODELO MODELE MODÈLE			ÁNGULOS / ANGLES / ANGLES			
	VEX 90 AC U	VEX 90 AA U	VEX 45 AC U	VEX 45 AA	VEX 90 AC UCP	VEX 90 AA UCP
PRECIO Price Prix						
MOD.	VEX 90 AC IU	VEX 90 AA IU	VEX 45 AC IU	VEX 45 AA I	VEX 90 AC IUCP	VEX 90 AA IUCP
<b>Precio PLANO INOX</b> Price STAINL.STEEL SURF. Prix PLAN INOX						
<b>Medidas</b> Measures (mm) Mesures	2769 x 1225 x 1220 mm.	1882 x 1225 x 1220 mm.	1531 x 1225 x 1220 mm.	1050 x 1225 x 1220 mm.	2769 x 1225 x 1220 mm.	1882 x 1225 x 1220 mm.
<b>Temperatura</b> Temperature (°C) Température	-1°C/+5°C					
<b>Clase Climática</b> Climatic class (°C) Classe climatique	4 / 30°C					
<b>Tensión/Frecuencia</b> Electrical data Tension électrique	230V/1ph/50Hz					
<b>Controlador</b> Controller Régulateur	Digital					
<b>Material</b> Matériel (EXT/INT)	Ext + Costados/Sides/Joues: acero plastificado / Plastified steel / Acier plastifié Encimera / Worktop / Dessous: Inox Aisi 304 Plano exposición / Exhibition plan / Plan d'exposition: Acero plastif./Plastif. steel/ Acier plastifié (Mod U/UCP) - Inox Aisi 304 (Mod. I)					
<b>Aislamiento</b> Isolation (mm)	40kg/m <sup>3</sup> / Free CFC's / Zero ODP-GWP					
<b>Capacidad</b> Capacity (L) Capacité	456	205	-	-	456	205
<b>Superficie exposición</b> Surface exhibition (m <sup>2</sup> ) Surface d'exposition	1,85	1,10	0,92	0,60	1,85	1,10
<b>Compresor</b> Compressor (HP) Compresseur	1/2	1/2	-	Sin unidad Without unity Sans unité	1/2	1/2
<b>Estantes</b> Shelving Étagères	-					
<b>Costados [2]</b> Sides [2] (mm) Joues [2]	30+30					
<b>Sistema de frío</b> Cooling System Système de froid	Ventilado / Ventilated / Ventilé					
<b>Desescarche</b> Defrost Dégivrage	Automático / Automatic / Automatique					
<b>Evaporación</b> Evaporation Évaporation	Forzada / Forced / Ventilé					
<b>Potencia</b> Power (W) Puissance	830	768	663	35	830	768
<b>Potencia frig.</b> Cooling capacity (W A -10°C) Puissance Frig.	-	-	-	Sin unidad Without unity Sans unité	-	-
<b>Consumo</b> Consumption (kWh/24h) Consommation	1,1	1,3	0,5	0,5	1,1	1,3
<b>Refrigerante</b> Refrigerant Gaz	R-290					
<b>Opcional</b> Optional Options	<b>Doble plano [sin reserva] / Double surface [without storage] / Double plan [sans réserve] - Modelo/Model/Modèle I: Inox</b>					
	<b>I:</b>					
	<b>Puertas correderas traseras / Rear sliding doors / Portes coulissantes arrière</b>					

**Laterales no incluidos en el precio**  
Side panels not included in price  
Joues non incluses dans le prix

Serie / Series / Série **VEX - EXPERIENCE**

+Info: [www.infrico.com](http://www.infrico.com)

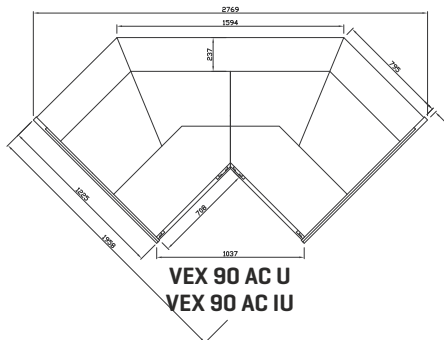

**VEX 90 AC U**  
**VEX 90 AC IU**

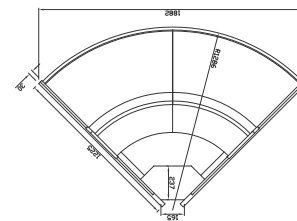

**VEX 90 AA U**  
**VEX 90 AA IU**

**Laterales / Sides / Joues**

**NO**

Izquierdo Left Gauche	Derecho Right Droite
-----------------------------	----------------------------

**Ext. Estándar / Standar / Standard**

Blanco/White/ Blanc	Ral 1015	Ral 1018
Ral 2003	Ral 3003	Ral 3020
Ral 5015	Ral 5017	Ral 5011
Ral 6002	Ral 6018	Ral 6019
Ral 7035	Ral 7037	Ral 7042
Ral 7016	Negro/Black/ Noir	Roble natural

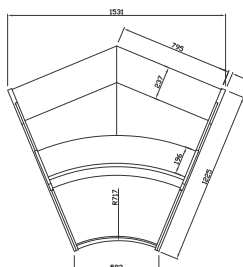

**VEX 45 AC U**  
**VEX 45 AC IU**

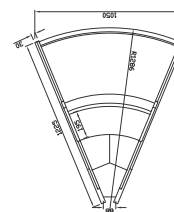

**VEX 45 AA U**  
**VEX 45 AA IU**

**Colores fuera de carta /**  
**Colors outside of letter /**  
**Couleurs spéciales, hors palette**

RAL		NO RAL	
Epoxi	Líquida/ Liquid/ Liquide	Epoxi	Líquida/ Liquid/ Liquide
[x unidad/x unit/x unité]		Consultar / Consultar / Consulter	
+10 días laborables / +10 work days / +10 jours ouvrés		Consultar / Consultar / Consulter	

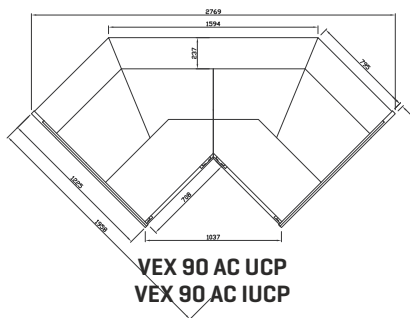



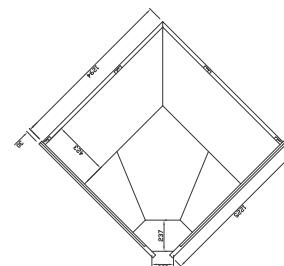



**VEX 90 AC UCP**  
**VEX 90 AC IUCP**



**VEX 90 AA UCP**  
**VEX 90 AA IUCP**

**Vitr. Experience torre de carne /**  
**Meat tower Experience display counter /**  
**Vitrine Experience tour de viande**

**Vitrina Experience caliente /**  
**Experience hot display counter /**  
**Vitrine Experience chaude**

MODELO MODELE MODÈLE	REMOTA / REMOTE / GROUPE À DIST.		GRUPO INCORP. / PLUG IN / GR. INCORPORÉ		CALIENTE / HOT / CHAUDE	
						
	<b>VEX09 CA</b>	<b>VEX12 CA</b>	<b>VEX09 U CA</b>	<b>VEX12 U CA</b>	<b>VEX12 CP HT</b>	<b>VEX25 CP HT</b>
<b>Precio</b> Price Prix						
<b>Medidas</b> Measures Mesures [mm]	<b>Sin costados</b> Without sides Sans joues 938 x 930 x 1500 mm.	<b>Sin costados</b> Without sides Sans joues 1250 x 930 x 1500 mm.	938 x 930 x 1500 mm.	1250 x 930 x 1500 mm.	1250 x 1225 x 1220 mm.	2500 x 1225 x 1220 mm.
<b>Temperatura</b> Temperature Température [°C]	<b>-1°C/+5°C</b>				<b>+65°C</b>	
<b>Clase Climática</b> Climatic class Classe climatique [°C]	4 / 30°C					
<b>Tensión/Frecuencia</b> Electrical data Tension électrique	230V/1ph/50Hz					380V/3ph/50Hz
<b>Controlador</b> Controller Régulateur	Digital					
<b>Material</b> Material Matériel [EXT/INT]	Ext + Costados/Sides/Joues: acero plastificado / Plastified steel / Acier plastifié Encimera / Worktop / Dessous: Inox Aisi 304 Plano exposición / Exhibition plan / Plan d'exposition: Acero plastif./ Plastif. steel/ Acier plastifié (Mod U/UCP) - Inox Aisi 304 (Mod. I)					
<b>Aislamiento</b> Isolation Isolation [mm]	40kg/m <sup>3</sup> / Free CFC's / Zero ODP-GWP					
<b>Capacidad</b> Capacity Capacité [L]	190	253	190	253	225	450
<b>Superficie exposición</b> Surface exhibition Surface d'exposition [m <sup>2</sup> ]	1,08	1,44	1,08	1,44	1,13	2,25
<b>Compresor</b> Compressor Compresseur [HP]	-		3 1/4	1 1/4	-	
<b>Estantes</b> Shelving Étagères	2				-	
<b>Costados [2]</b> Sides [2] Joues [2] [mm]	30+30		<b>Laterales NO incluidos</b> NOT Side panels included NON Joues inclus		<b>Laterales incluidos</b> Side panels included Joues inclus	
<b>Sistema de frío</b> Cooling System Système de froid	Ventilado / Ventilated / Ventilé				-	
<b>Desescarche</b> Defrost Dégivrage	Automático / Automatic / Automatique				-	
<b>Evaporación</b> Evaporation Évaporation	Forzada / Forced / Ventilé				-	
<b>Potencia</b> Power Puissance [W]	-		784	893	2153	4305
<b>Potencia frig.</b> Cooling capacity Puissance Frig. [W A -10°C]	1500	2200	-			
<b>Consumo</b> Consumption Consommation [kWh/ 24h]	-		12,1	14,3	12,9	25,8
<b>Refrigerante</b> Refrigerant Gaz	<b>FREON</b>		<b>R-290</b>			-
<b>Opcional</b> Optional Options	<b>Separador panorámico /</b> Panoramic divider / Séparateur panoramique				-	

**Laterales no incluidos en el precio**  
**Side panels not included in price**  
**Joues non incluses dans le prix**

Serie / Series / Série **VEX - EXPERIENCE**

+Info: [www.infrico.com](http://www.infrico.com)

VEX25 CP HT



**Laterales / Sides / Joues**

<b>VEX / CP HT</b>	
<b>Incluidos / Includes / Inclus</b>	

**Laterales / Sides / Joues VEX CA/UCA**

<b>NO</b>	
Izquierdo Left Gauche	Derecho Right Droite



VEX12 CA

**Ext. Estándar / Standar / Standard**

Blanco/White/ Blanc	Ral 1015	Ral 1018
Ral 2003	Ral 3003	Ral 3020
Ral 5015	Ral 5017	Ral 5011
Ral 6002	Ral 6018	Ral 6019
Ral 7035	Ral 7037	Ral 7042
Ral 7016	Negro/Black/ Noir	Roble natural

**Colores fuera de carta /  
Colors outside of letter /  
Couleurs spéciales, hors palette**

RAL		NO RAL	
Epoxi	Líquida/ Liquid/ Liquide	Epoxi	Líquida/ Liquid/ Liquide
[x unidad/x unit/x unité]		Consultar / Consultar / Consultar	
+10 días laborables / +10 work days / +10 jours ouvrés		Consultar / Consultar / Consultar	

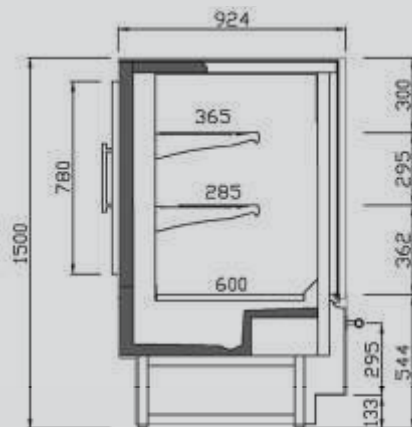



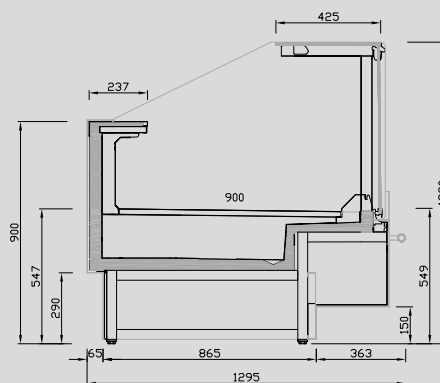











VEX CA



VEX CP HT



# Vitrina Experience remota / Experience refrigerated self service remote case / Vitrine Experience groupe à distance

		CRISTAL RECTO / FLAT GLASS / VITRE DROITE					
MODELO MODELE MODÈLE							
Precio Price Prix							
MOD.	VEX09 I CP	VEX12 I CP	VEX15 I CP	VEX18 I CP	VEX25 I CP	VEX31 I CP	VEX37 I CP
Precio PLANO INOX Price STAINL. STEEL SURF. Prix PLAN INOX							
		CRISTAL CURVO / CURVED GLASS / VITRE BOMBÉE					
MODELO MODELE MODÈLE							
Precio Price Prix							
MOD.	VEX09 I	VEX12 I	VEX15 I	VEX18 I	VEX25 I	VEX31 I	VEX37 I
Precio PLANO INOX Price STAINL. STEEL SURF. Prix PLAN INOX							
Medidas / Measures / Mesures / (mm) Sin costados / Without sides / Sans joues	938 x 1295 x 1220 mm.	1250 x 1295 x 1220 mm.	1562 x 1295 x 1220 mm.	1875 x 1295 x 1220 mm.	2500 x 1295 x 1220 mm.	3125 x 1295 x 1220 mm.	3750 x 1295 x 1220 mm.
Temperatura Temperature Température (°C)	-1°C/+5°C						
Clase Climática Climatic class Classe climatique (°C)	4 / 30°C						
Tensión/Frecuencia Electrical data Tension électrique	230V/1ph/50Hz						
Controlador Controller Régulateur	Digital						
Material Material Matériel (EXT/INT)	Ext + Costados/Sides/Joues: acero plastificado / Plastified steel / Acier plastifié Encimera / Worktop / Dessous: Inox Aisi 304 Plano exposición / Exhibition plan / Plan d'exposition: Acero plastif./ Plastif. steel/ Acier plastifié [Mod U/UCP] - Inox Aisi 304 [Mod. I]						
Aislamiento Isolation Isolation (mm)	40kg/m³ / Free CFC's / Zero ODP-GWP						
Capacidad Capacity Capacité (L)	169	225	281	338	450	563	675
Superficie exposición Surface exhibition Surface d'exposition (m²)	0,84	1,13	1,41	1,69	2,25	2,81	3,40
Compresor Compressor Compresseur (HP)	-						
Costados (2) Sides (2) Joues (2) (mm)	30 + 30						
Sistema de frío Cooling System Système de froid	Ventilado / Ventilated / Ventilé						
Desescarche Defrost Dégivrage	Automático / Automatic / Automatique						
Evaporación Evaporation Evaporation	Forzada / Forced / Ventilé						
Potencia frig. Cooling capacity Puissance Frig. (W A -10°C)	610	813	1015	1219	1626	2031	2438
Refrigerante Refrigerant Gaz	FREON						
Puertas correderas traseras / Rear sliding doors / Portes coulissantes arrière							
R	R	R	R	R	R	R	R
P	P	P	P	P	P	P	P
Doble Plano / Double surface / Double plan							
Doble plano Inox / Stainless steel double surface / Double plan Inox							
Control de Condensación SSC / SCC Condensing Control / Contrôle de la Condensation SCC							

R: CRISTAL CURVO / CURVED GLASS / VITRE BOMBÉE  
P: CRISTAL RECTO / FLAT GLASS / VITRE DROITE

Laterales no incluidos en el precio  
Side panels not included in price  
Joues non incluses dans le prix



Serie / Series / Série **VEX - EXPERIENCE**

+Info: [www.infrico.com](http://www.infrico.com)

VEX25CP



**Laterales / Sides / Joues**

NO	
Izquierdo Left Gauche	Derecho Right Droite



VEX25

**Ext. Estándar / Standar / Standard**

Blanco/White/ Blanc	Ral 1015	Ral 1018
Ral 2003	Ral 3003	Ral 3020
Ral 5015	Ral 5017	Ral 5011
Ral 6002	Ral 6018	Ral 6019
Ral 7035	Ral 7037	Ral 7042
Ral 7016	Negro/Black/ Noir	

**Colores fuera de carta /  
Colors outside of letter /  
Couleurs spéciales, hors palette**

RAL		NO RAL	
Epoxi	Líquida/ Liquid/ Liquide	Epoxi	Líquida/ Liquid/ Liquide
[x unidad/x unit/x unité]		Consultar / Consultar / Consulter	
+10 días laborables / +10 work days / +10 jours ouvrés		Consultar / Consultar / Consulter	

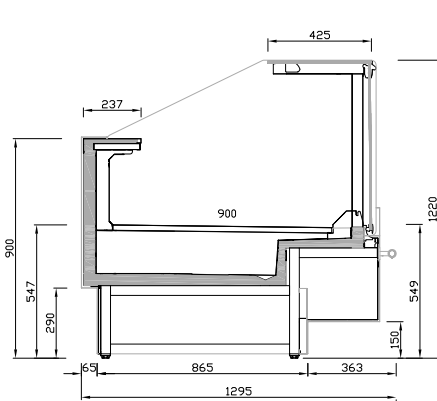

VEX CP

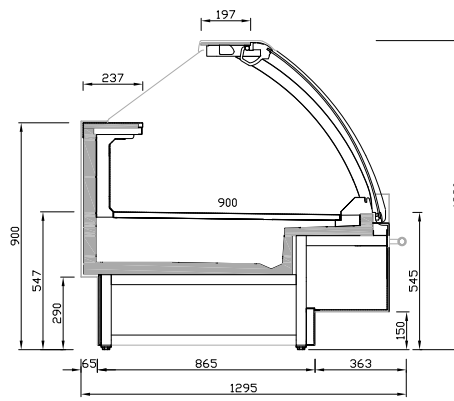





VEX



# Vitrina Experience remota / Experience refrigerated self service remote case / Vitrine Experience groupe à distance

## CRISTAL BAJO / LOW GLASS / VITRE BASS

MODELO MODELE MODÈLE	 VEX09 CB	 VEX12 CB	 VEX15 CB	 VEX18 CB	 VEX25 CB
Precio Price Prix					
MOD.	VEX09 I CB	VEX12 I CB	VEX15 I CB	VEX18 I CB	VEX25 I CB
Precio PLANO INOX Price STAINL. STEEL SURF. Prix PLAN INOX					
Medidas / Measures / Mesures / [mm] Sin costados / Without sides / Sans joues	938 x 1225 x 875 mm.	1250 x 1225 x 875 mm.	1562 x 1225 x 875 mm.	1875 x 1225 x 875 mm.	2500 x 1225 x 875 mm.
Temperatura Temperature [°C] Température	-1°C/+7°C				
Clase Climática Climatic class [°C] Classe climatique	4 / 30°C				
Tensión/Frecuencia Electrical data Tension électrique	230V/1ph/50Hz				
Controlador Controller Régulateur	Digital				
Material Material [EXT/INT] Matériel	Ext + Costados/Sides/Joues: acero plastificado / Plastified steel / Acier plastifié Encimera / Worktop / Dessous: Inox Aisi 304 Plano exposición / Exhibition plan / Plan d'exposition: Acero plastif./ Plastif. steel/ Acier plastifié [Mod U/UCP] - Inox Aisi 304 [Mod. I]				
Aislamiento Isolation [mm] Isolation	40kg/m <sup>3</sup> / Free CFC's / Zero ODP-GWP				
Capacidad Capacity [L] Capacité	169	225	281	338	450
Superficie exposición Surface exhibition [m <sup>2</sup> ] Surface d'exposition	0,84	1,13	1,41	1,69	2,25
Compresor Compressor [HP] Compresseur	-				
Costados [2] Sides [2] Joues [2]	30 + 30				
Sistema de frío Cooling System Système de froid	Ventilado / Ventilated / Ventilé				
Desescarche Defrost Dégivrage	Automático / Automatic / Automatique				
Evaporación Evaporation Evaporation	Forzada / Forced / Ventilé				
Potencia Power [W] Puissance	-				
Potencia frig. Cooling capacity [W A -10°C] Puissance Frig.	750	1000	1250	1500	2000
Consumo Consumption [kWh/ 24h] Consommation	-				
Refrigerante Refrigerant Gaz	FREON				
Opcional Optional Options	Doble Plano / Double surface / Double plan	Doble Plano / Double surface / Double plan	Doble Plano / Double surface / Double plan	Doble Plano / Double surface / Double plan	Doble Plano / Double surface / Double plan
	Doble plano Inox / Stainl. steel double surface / Double plan Inox	Doble plano Inox / Stainl. steel double surface / Double plan Inox	Doble plano Inox / Stainl. steel double surface / Double plan Inox	Doble plano Inox / Stainl. steel double surface / Double plan Inox	Doble plano Inox / Stainl. steel double surface / Double plan Inox

Laterales no incluidos en el precio  
Side panels not included in price  
Joues non incluses dans le prix

Serie / Series / Série **VEX - EXPERIENCE**

+Info: [www.infrico.com](http://www.infrico.com)

VEX25CB



Laterales / Sides / Jouses

**NO**

Izquierdo Left Gauche	Derecho Right Droite
-----------------------------	----------------------------



Ext. Estándar / Standar / Standard

Blanco/White/ Blanc	Ral 1015	Ral 1018
Ral 2003	Ral 3003	Ral 3020
Ral 5015	Ral 5017	Ral 5011
Ral 6002	Ral 6018	Ral 6019
Ral 7035	Ral 7037	Ral 7042
Ral 7016	Negro/Black/ Noir	

VEX25CB

Colores fuera de carta /  
Colors outside of letter /  
Couleurs spéciales, hors palette



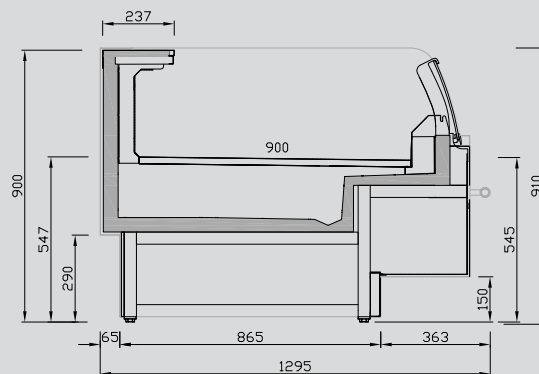

RAL		NO RAL	
Epoxi	Líquida/ Liquid/ Liquide	Epoxi	Líquida/ Liquid/ Liquide
[x unidad/x unit/x unité]		Consultar / Consultar / Consulter	
+10 días laborables / +10 work days / +10 jours ouvrés		Consultar / Consultar / Consulter	



VEX CB



# Vitrina Experience remota / Experience refrigerated self service remote case / Vitrine Experience groupe à distance

MODELO MODELE MODÈLE			ÁNGULOS / ANGLES / ANGLES			
	VEX 90 AC	VEX 90 AA	VEX 45 AC	VEX 45 AA	VEX 90 AC CP	VEX 90 AA CP
Precio Price Prix						
MOD.	VEX 90 ACI	VEX 90 AAI	VEX 45 ACI	VEX 45 AAI	VEX 90 AC I CP	VEX 90 AA I CP
Precio PLANO INOX Price STAINL.STEEL SURF. Prix PLAN INOX						
Medidas / Measures / Mesures / [mm] Sin costados / Without sides / Sans joues	2769 x 1225 x 1220 mm.	1882 x 1225 x 1220 mm.	1531 x 1225 x 1220 mm.	1050 x 1225 x 1220 mm.	2769 x 1225 x 1220 mm.	1882 x 1225 x 1220 mm.
Temperatura Temperature [°C] Température	-1°C/+7°C					
Clase Climática Climatic class [°C] Classe climatique	4 / 30°C					
Tensión/Frecuencia Electrical data Tension électrique	230V/1ph/50Hz					
Controlador Controller Régulateur	Digital					
Material Material [EXT/INT]	Ext + Costados/Sides/Joues: acero plastificado / Plastified steel / Acier plastifié Encimera / Worktop / Dessous: Inox Aisi 304 Plano exposición / Exhibition plan / Plan d'exposition: Acero plastif./ Plastif. steel/ Acier plastifié [Mod U/UCP] - Inox Aisi 304 [Mod. I]					
Aislamiento Isolation [mm]	40kg/m <sup>3</sup> / Free CFC's / Zero ODP-GWP					
Capacidad Capacity [L] Capacité	456	205	-	-	456	205
Superficie exposición Surface exhibition [m <sup>2</sup> ] Surface d'exposition	1,85	1,10	0,92	0,60	1,85	1,10
Compresor Compressor [HP] Compresseur	-					
Estantes Shelving Étagères	-					
Costados [2] Sides [2] [mm] Joues [2]	30+30					
Sistema de frío Cooling System Système de froid	Ventilado / Ventilated / Ventilé					
Desescarche Defrost Dégivrage	Automático / Automatic / Automatique					
Evaporación Evaporation Évaporation	Forzada / Forced / Ventilé					
Potencia Power [W] Puissance	-					
Potencia frig. Cooling capacity [W A -10°C] Puissance Frig.	1700	855	852	NEUTRO	1790	900
Consumo Consumption [kWh/ 24h] Consommation	-					
Refrigerante Refrigerant Gaz	FREON					
Opcional Optional Options	Doble plano [sin reserva] / Double surface [without storage] / Double plan [sans réserve] - Modelo/Model/Modèle I: Inox					
	I:	I:	I:	I:	I:	I:
	Puertas correderas traseras / Rear sliding doors / Portes coulissantes arrière					
	Control de Condensación SSC / SCC Condensing Control / Contrôle de la Condensation SCC					

**Laterales no incluidos en el precio**  
Side panels not included in price  
Joues non incluses dans le prix

Serie / Series / Série **VEX - EXPERIENCE**

+Info: [www.infrico.com](http://www.infrico.com)

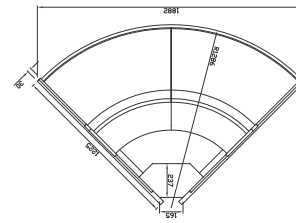
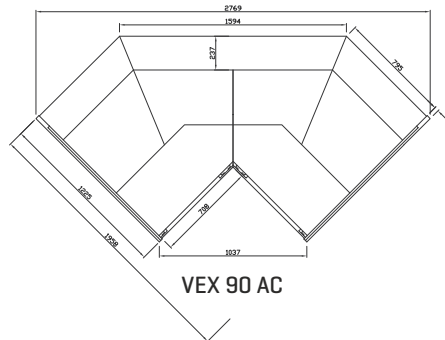

Laterales / Sides / Joues

NO	
Izquierdo Left Gauche	Derecho Right Droite

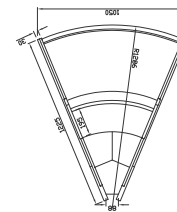
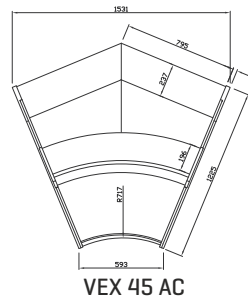

Ext. Estándar / Standar / Standard

Blanco/White/ Blanc	Ral 1015	Ral 1018
Ral 2003	Ral 3003	Ral 3020
Ral 5015	Ral 5017	Ral 5011
Ral 6002	Ral 6018	Ral 6019
Ral 7035	Ral 7037	Ral 7042
Ral 7016	Negro/Black/ Noir	





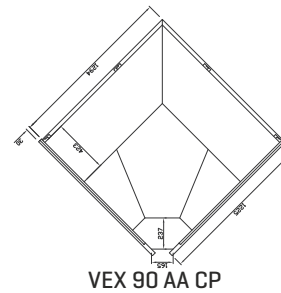
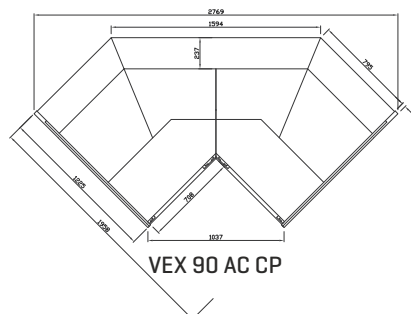

Colores fuera de carta /  
Colors outside of letter /  
Couleurs spéciales, hors palette

RAL		NO RAL	
Epoxi	Líquida/ Liquid/ Liquide	Epoxi	Líquida/ Liquid/ Liquide
[x unidad/x unit/x unité]		Consultar / Consultar / Consulter	
+10 días laborables / +10 work days / +10 jours ouvrés		Consultar / Consultar / Consulter	



**Vitrina estrecha remota Take Away /**  
**Narrow remote Take Away refrig. display counter /**  
**Vitrine étroite Take Away groupe à distance**

**Vitr. Experience torre de carne /**  
**Meat tower Experience display counter /**  
**Vitrine Experience tour de viande**

MODELO MODELE MODÈLE	 VEE 12	 VEE 18	 VEE 25	 VEE 09 CA	 VEE CA	 VEE 12 CA
Precio Price Prix						
Medidas / Measures / Mesures / (mm) Sin costados / Without sides / Sans joues	1250 x 930 x 1220 mm.	1875 x 930 x 1220 mm.	2500 x 930 x 1220 mm.	938 x 930 x 1500 mm.		1250 x 930 x 1500 mm.
Temperatura Temperature (°C) Température	-1°C/+5°C					
Clase Climática Climatic class (°C) Classe climatique	4 / 30°C					
Tensión/Frecuencia Electrical data Tension électrique	230V/1ph/50Hz					
Controlador Controller Régulateur	Digital					
Material Material (EXT/INT) Matériel	Ext: acero plastificado / Plastified stainless steel / Acier plastifié Encimera / Worktop / Dessous: Inox Aisi 304 Plano exposición / Exhibition plan / Plan d'exposition: Inox Aisi 304					
Aislamiento Isolation (mm) Isolation	40kg/m <sup>3</sup> / Free CFC's / Zero ODP-GWP					
Capacidad Capacity (L) Capacité	225	338	450	312		416
Superficie exposición Surface exhibition (m <sup>2</sup> ) Surface d'exposition	0,75	1,13	1,50	1,14		1,51
Compresor Compressor (HP) Compresseur	-					
Costados [2] Sides [2] (mm) Joues [2]	30 + 30					
Sistema de frío Cooling System Système de froid	Ventilado / Ventilated / Ventilé					
Desescarche Defrost Dégivrage	Automático / Automatic / Automatique			Gas caliente / hot gas / Gaz chaud		
Evaporación Evaporation Évaporation	Forzada / Forced / Ventilé					
Potencia Power (W) Puissance	-					
Potencia frig. Cooling capacity (W A -10°C) Puissance Frig.	723	1164	1598	1453		1598
Consumo Consumption (kWh/ 24h) Consommation	-					
Refrigerante Refrigerant Gaz	R-290					
Opcional Optional Options	Puertas correderas / Sliding doors / Portes coulissantes  VEE 12  VEE 18  VEE 25					

**Laterales no incluidos en el precio**  
**Side panels not included in price**  
**Joues non incluses dans le prix**

Serie / Series / Série **VEE - CALIFORNIA**

+Info: [www.infrico.com](http://www.infrico.com)

VEE25



**Laterales / Sides / Joues**

NO	
Izquierdo Left Gauche	Derecho Right Droite

**Ext. Estándar / Standar / Standard**

Blanco/White/ Blanc	Ral 1015	Ral 1018
Ral 2003	Ral 3003	Ral 3020
Ral 5015	Ral 5017	Ral 5011
Ral 6002	Ral 6018	Ral 6019
Ral 7035	Ral 7037	Ral 7042
Ral 7016	Negro/Black/ Noir	

**Colores fuera de carta /  
Colors outside of letter /  
Couleurs spéciales, hors palette**

RAL		NO RAL	
Epoxi	Líquida/ Liquid/ Liquide	Epoxi	Líquida/ Liquid/ Liquide
			Consultar / Consulter / Consulter
[x unidad/x unit/x unité]			
+10 días laborables / +10 work days / +10 jours ouvrés			Consultar / Consulter / Consulter



VEE12 CA

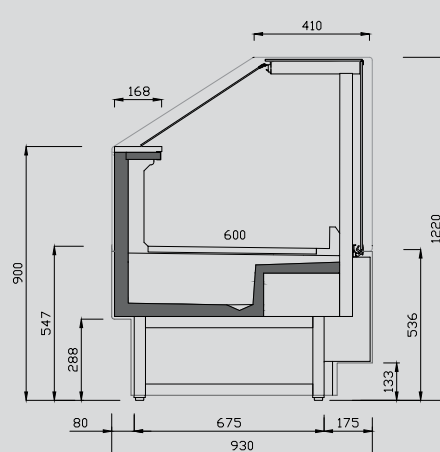



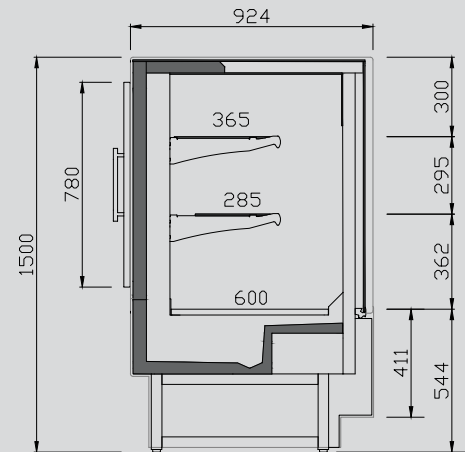



VEE



VEE CA



**Vitrina Experience caliente** / Experience hot display counter / Vitrine Experience chaude **(VEE HT)**  
**Vitr. Experience Gastronorm** / Experience Gastronorm disp. count. / Vit. Experience Gastronorme **(VEE GC)**  
**Vitrina Experience estrecha** / Experience narrow display counter / Vitrine Experience étroite **(VEES)**  
**Vitrina Experience neutra** / Experience neutral display counter / Vitrine Experience neutre **(VEEN-VEEC)**

MODELO MODELE MODÈLE	 VEE 12 HT	 VEE 12 GC	 VEE 12 S	 VEE 90 AAM	 VEE 06 C	 VEE 09 C
Precio Price Prix						
Medidas / Measures / Mesures / (mm)	1330 x 930 x 1220 mm.	1330 x 930 x 1220 mm.	1250 x 930 x 1220 mm.	1330 x 930 x 907 mm.	687 x 930 x 907 mm.	1000 x 930 x 907 mm.
Temperatura Temperature Température (°C)	<b>+65°C</b>		<b>-1°C/+5°C</b>		-	
Clase Climática Climatic class Classe climatique (°C)	-		4 / 30°C		-	
Tensión/Frecuencia Electrical data Tension électrique	230V/1ph/50Hz					
Controlador Controller Régulateur	Digital					
Material Material Matériel (EXT/INT)	Ext: acero plastificado / Plastified stainless steel / Acier plastifié Encimera / Worktop / Dessous: Inox Aisi 304 Plano exposición / Exhibition plan / Plan d'exposition: Inox Aisi 304					
Aislamiento Isolation Isolation (mm)	40kg/m <sup>3</sup> / Free CFC's / Zero ODP-GWP					
Capacidad Capacity Capacité (L)	225	90	135		-	
Superficie exposición Surface exhibition Surface d'exposition (m <sup>2</sup> )	0,75	-	0,89		-	
Compresor Compressor Compresseur (HP)	-					
Costados [2] Sides [2] Joues [2] (mm)	30 + 30					
Sistema de frío Cooling System Système de froid	Ventilado / Ventilated / Ventilé					
Desescarche Defrost Dégivrage	Automático / Automatic / Automatique					
Evaporación Evaporation Évaporation	Forzada / Forced / Ventilé					
Potencia Power Puissance (W)	2250	2600	-		-	
Potencia frig. Cooling capacity Puissance Frig. (W A -10°C)	-	-	1522		-	
Consumo Consumption Consommation (kWh/ 24h)	21,6	24,9	-		-	
Refrigerante Refrigerant Gaz	<b>R-290</b>				-	
Opcional Optional Options	<b>Puertas correderas / Sliding doors / Portes coulissantes VEE 12 S</b>				-	

**Laterales no incluidos en el precio**  
**Side panels not included in price**  
**Joues non incluses dans le prix**



Serie / Series / Série **VEE - CALIFORNIA**

+Info: [www.infrico.com](http://www.infrico.com)



VEE 12 HT



VEE 12 GC



VEE 12 S

**Laterales / Sides / Jous**

**VEE HT / GC / AAM**  
Incluidos / Includes / Inclus

**Laterales / Sides / Jous**

NO	
Izquierdo Left Gauche	Derecho Right Droite

VEE 90 AAMS



**Ext. Estándar / Standar / Standard**

Blanco/White/ Blanc	Ral 1015	Ral 1018
Ral 2003	Ral 3003	Ral 3020
Ral 5015	Ral 5017	Ral 5011
Ral 6002	Ral 6018	Ral 6019
Ral 7035	Ral 7037	Ral 7042
Ral 7016	Negro/Black/ Noir	

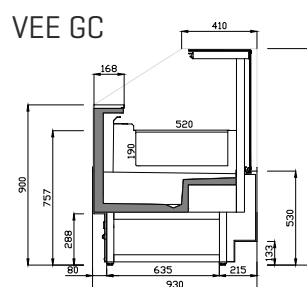
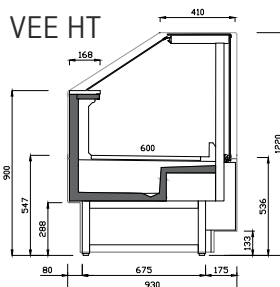





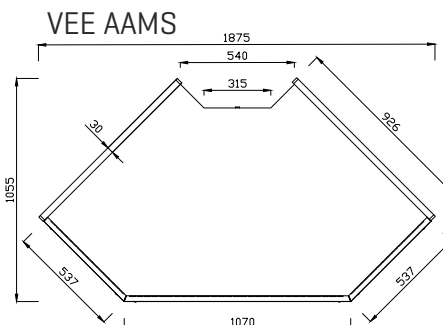
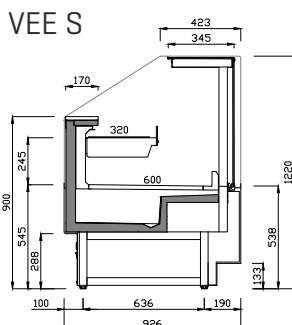

**Colores fuera de carta / Colors outside of letter / Couleurs spéciales, hors palette**

RAL		NO RAL	
Epoxi	Líquida/ Liquid/ Liquide	Epoxi	Líquida/ Liquid/ Liquide
[x unidad/x unit/x unité]		Consultar / Consultar / Consulter	
+10 días laborables / +10 work days / +10 jours ouvrés		Consultar / Consultar / Consulter	



**Vitrina estrecha grupo incorporado / Narrow plug in refrigerated display counter / Vitrine étroite groupe incorporé (VEE U)**  
**Vitr. torre de carne grupo incorp. / Meat tower plug in display counter / Vitrine tour de viande groupe incorporé (VEE U CA)**  
**Vitrina estrecha Take Away / Take Away narrow display counter / Vitrine étroite Take Away (VEE U S)**

MODELO MODELE MODÈLE						
Precio Price Prix						
Medidas Measures Mesures [mm]	1250 x 930 x 1220 mm.	1875 x 930 x 1220 mm.	2500 x 930 x 1220 mm.	938 x 930 x 1500 mm.	1250 x 930 x 1500 mm.	1250 x 930 x 1220 mm.
Temperatura Temperature Température [°C]	-1°C/+5°C					
Clase Climática Climatic class Classe climatique [°C]	4 / 30°C					
Tensión/Frecuencia Electrical data Tension électrique	230V/1ph/50Hz					
Controlador Controller Régulateur	Digital					
Material Material Matériel [EXT/INT]	Ext: acero plastificado / Plastified stainless steel / Acier plastifié Encimera / Worktop / Dessous: Inox Aisi 304 Plano exposición / Exhibition plan / Plan d'exposition: Inox Aisi 304					
Aislamiento Isolation Isolation [mm]	40kg/m <sup>3</sup> / Free CFC's / Zero ODP-GWP					
Capacidad Capacity Capacité [L]	150	225	300	190	253	150
Superficie exposición Surface exhibition Surface d'exposition [m <sup>2</sup> ]	0,75	1,13	1,50	1,08	1,44	0,89
Compresor Compressor Compresseur [HP]	1/3	3/4	1	3/4	1	1/3
Costados [2] Sides [2] Joues [2] [mm]	30 + 30					
Sistema de frío Cooling System Système de froid	Ventilado / Ventilated / Ventilé					
Desescarche Defrost Dégivrage	Automático / Automatic / Automatique			Gas caliente / hot gas / Gaz chaud		Automático / Automatic / Automatique
Evaporación Evaporation Évaporation	Forzada / Forced / Ventilé					
Potencia Power Puissance [W]	374	541	642	784	893	374
Potencia frig. Cooling capacity Puissance Frig. [W A -10°C]	-					
Consumo Consumption Consommation [kWh/ 24h]	6,98	10,76	12,81	12,17	14,32	7,8
Refrigerante Refrigerant Gaz	R-290					
Opcional Optional Options	Puertas correderas / Sliding doors / Portes coulissantes  VEE 12  VEE 18  VEE 25			-		Puertas correderas / Sliding doors / Portes coulissantes

**Laterales no incluidos en el precio**  
**Side panels not included in price**  
**Joues non incluses dans le prix**



Serie / Series / Série **VEE - CALIFORNIA**

+Info: [www.infrico.com](http://www.infrico.com)

VEE25 U



**Laterales / Sides / Jous**

NO	
Izquierdo Left Gauche	Derecho Right Droite



**Ext. Estándar / Standar / Standard**

Blanco/White/ Blanc	Ral 1015	Ral 1018
Ral 2003	Ral 3003	Ral 3020
Ral 5015	Ral 5017	Ral 5011
Ral 6002	Ral 6018	Ral 6019
Ral 7035	Ral 7037	Ral 7042
Ral 7016	Negro/Black/ Noir	

VEE12 U CA

**Colores fuera de carta /  
Colors outside of letter /  
Couleurs spéciales, hors palette**

RAL		NO RAL	
Epoxi	Líquida/ Liquid/ Liquide	Epoxi	Líquida/ Liquid/ Liquide
[x unidad/x unit/x unité]		Consultar / Consulter / Consulter	
+10 días laborables / +10 work days / +10 jours ouvrés		Consultar / Consulter / Consulter	

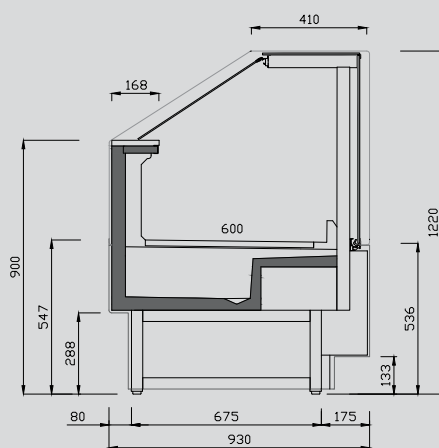

VEE U

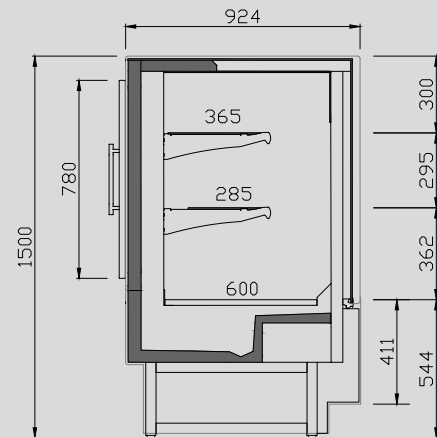

VEE U CA





+Info: [www.infrico.com](http://www.infrico.com)



**Vitrina promocional grupo incorporado /**  
**Promotional plug in counter /**  
**Vitrine promotionnelle groupe incorporé**

MODELO MODELE MODÈLE	VVS		SVS				VCD	VVL		
	VVS 10	VVS 12	SVS 10 E1	SVS 10 E2	SVS 12 E1	SVS 12 E2	VCD 10	VVL 10	VVL 12	
<b>Precio</b> Price Prix										
<b>Medidas</b> Measures [mm] Mesures	938 x 1000 x 950 mm.	1250 x 1000 x 950 mm.	938 x 1000 x 1200 mm.	938 x 1000 x 1300 mm.	1250 x 1000 x 1200 mm.	1250 x 1000 x 1300 mm.	1250 x 1250 x 950 mm.	1106 x 1167 x 954 mm.	1425 x 1167 x 954 mm.	
<b>Temperatura</b> Temperature [°C] Température	-1°C/+7°C						-1°C/+1°C -22°C/-25°C	-1°C/+7°C		
<b>Clase Climática</b> Climatic class [°C] Classe climatique	4 / 30°C									
<b>Tensión/Frecuencia</b> Electrical data Tension électrique	230V/1ph/50Hz									
<b>Controlador</b> Controller Régulateur	Digital									
<b>Material</b> Material [EXT/INT] Matériel	Acero epoxi / Epoxy steel / Acier epoxy									
<b>Aislamiento</b> Isolation [mm] Isolation	40kg/m <sup>3</sup> / Free CFC's / Zero ODP-GWP						40kg/m <sup>3</sup> / Free CFC's / Zero ODP-GWP			
<b>Capacidad</b> Capacity [L] Capacité	105	150	155	210	190	260	244	125	176	
<b>Superficie exposición</b> Surface exhibition [m <sup>2</sup> ] Surface d'exposition	0,64	0,85	0,97	1,20	1,30	1,60	1,06	0,85	1,14	
<b>Compresor</b> Compressor [HP] Compresseur	1/3	1/3	3/4	3/4	3/4	3/4	3/5	1/3	1/3	
<b>Costados [2]</b> Sides [2] [mm] Joues [2]	-						42			
<b>Sistema de frío</b> Cooling System Système de froid	Ventilado / Ventilated / Ventilé									
<b>Desescarche</b> Defrost Dégivrage	Automático / Automatic / Automatique									
<b>Evaporación</b> Evaporation Évaporation	Forzada / Forced / Ventilé									
<b>Potencia</b> Power [W] Puissance	529	529	681	696	681	696	555	413	413	
<b>Potencia frig.</b> Cooling capacity [W A -10°C] Puissance Frig.	-									
<b>Consumo</b> Consumption [kWh/ 24h] Consommation	12,7	12,7	15,1	15,4	15,1	15,4	10,6	6,72	8,08	
<b>Refrigerante</b> Refrigerant Gaz	R-290									
<b>Opcional</b> Optional Options							Iluminación doble exposición 3000K / Double LED lighting 3000K color in exhibition area / Éclairage à double exposition 3000K		Tapa / Lid / Couverture	

Serie / Series / Série **VISION**

+Info: [www.infrico.com](http://www.infrico.com)

VVS 10



SVS 10E2



VCD 10

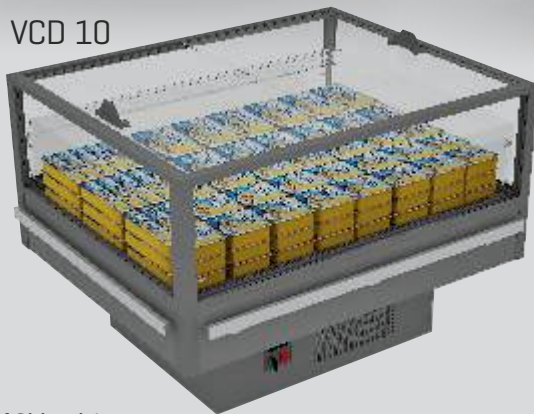

VWL 12



**Laterales / Sides / Joues**

**Incluidos / Includes / Inclus**



# Islas / Horizontal freezers / Îlots congélation







9





**Isla de congelación cerrada estática /**  
**Static closed horizontal freezer /**  
**Îlot panoramique de congélation fermé statique**

**Armario combi superior para isla de congelación /**  
**Top combi cabinet for horizontal freezer /**  
**Armoire combi supérieure pour îlot de congélation**

MODELO MODELE MODÈLE				
<b>Precio</b> Price Prix				
<b>Medidas</b> Measures [mm] Mesures	2100 x 980 x 1030 mm.	2500 x 980 x 1220 mm.	930 x 980 x 2100 mm.	2500 x 750 x 2342 mm.
<b>Temperatura</b> Temperature [°C] Température	<b>-15°C/-18°C</b>			
<b>Clase Climática</b> Climatic class [°C] Classe climatique	3 / 25°C			
<b>Tensión/Frecuencia</b> Electrical data Tension électrique	230V/1ph/50Hz			
<b>Controlador</b> Controller Régulateur	Digital			
<b>Material</b> Material [EXT/INT] Matériel	Ext: acero plastificado / Plastified stainless steel / Acier plastifié Encimera / Worktop / Dessous: Inox Aisi 304 Plano exposición / Exhibition plan / Plan d'exposition: Inox Aisi 304			
<b>Aislamiento</b> Isolation [mm] Isolation	40kg/m <sup>3</sup> / Free CFC's / Zero ODP-GWP			
<b>Capacidad</b> Capacity [L] Capacité	682	813	682	368
<b>Superficie exposición</b> Surface exhibition [m <sup>2</sup> ] Surface d'exposition	1,20	1,42	1,20	3,06
<b>Compresor</b> Compressor [HP] Compresseur	1 1/4	1 1/4	1 1/4	2/5
<b>Costados [2]</b> Sides [2] Joues [2]	-			
<b>Sistema de frío</b> Cooling System Système de froid	Estático / Static / Estatique			Ventilado / Ventilated / Ventilé
<b>Desescarche</b> Defrost Dégivrage	Automático / Automatic / Automatique			Gas caliente/ Hot gas / Gaz chaud
<b>Evaporación</b> Evaporation Évaporation	Forzada / Forced / Ventilé			
<b>Potencia</b> Power [W] Puissance	1803	2042	1803	1240
<b>Potencia frig.</b> Cooling capacity [W A -10°C] Puissance Frig.	-			
<b>Consumo</b> Consumption [kWh/ 24h] Consommation	12,1	14,5	12,1	24,0
<b>Refrigerante</b> Refrigerant Gaz	<b>R-290</b>			
<b>Opcional</b> Optional Options	<b>Parrilla divisoria / Divider wire / Grille de séparation</b>  <b>Kit unión lateral / Lateral assembly kit / Kit union latérale</b>  <b>Kit unión zócalo / Base assembly kit / Kit union latérale</b>  <b>Kit unión cabecera / Header assembly kit / Kit union îlot de tête</b>			-
	<b>Doble iluminación LED [encimera] /</b> Double LED lighting [worktop] / Double éclairage LED [dessus]	<b>Doble iluminación LED [encimera] /</b> Double LED lighting [worktop] / Double éclairage LED [dessus]		
	<b>Kit unión espalda /</b> Back modules assembly kit / Kit union arrière	<b>Kit unión espalda /</b> Back modules assembly kit / Kit union arrière		



Serie / Series / Série **GD**  
 Serie / Series / Série **COMBI**

+Info: [www.infrico.com](http://www.infrico.com)

GD25 PL1

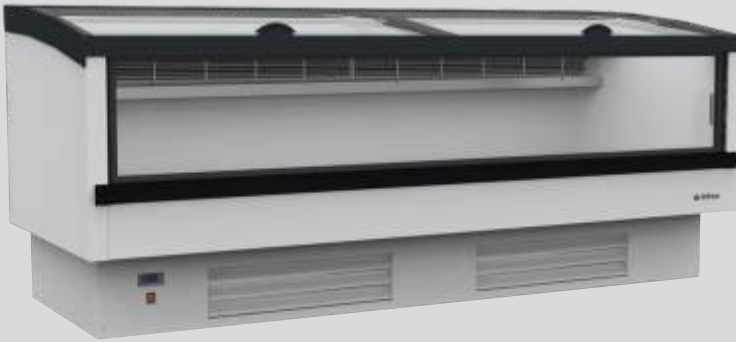

Laterales / Sides / Joes

Incluidos / Includes / Inclus

Decor. Interior / Exterior  
 Interior Decor./ Exterior  
 Décor. Intérieure / Extérieure

Ral 9016  
 Blanco  
 White  
 Blanc

Ral 7016  
 Gris antracita  
 Anthracite  
 Gris anthracite

GD PL1

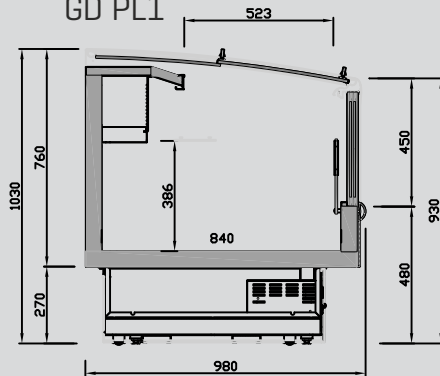

GD C PL1

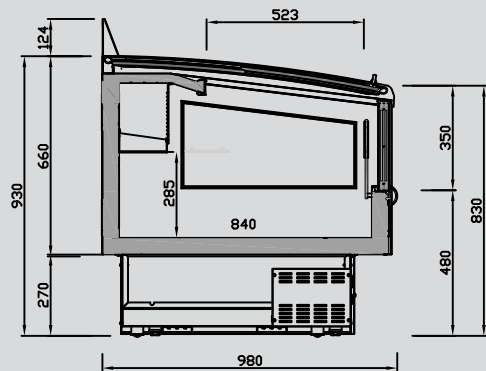

AS 25UL1

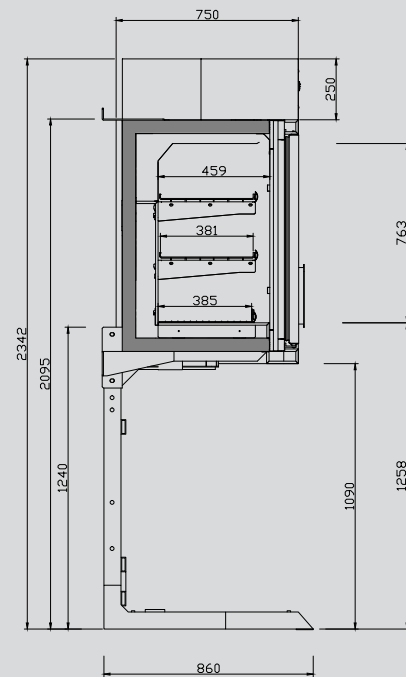

AS 25UL1



# Murales

## Multidecks / Murales





Serie / Series / Série

# SMDG SMPB Edimburgo



SML DG  
SML PB \_\_\_\_\_ 346-347

Serie / Series / Série

# SMDCP Dublín



SMS DCP/DCPC  
SML DCP/DCPC \_\_\_\_\_ 348-349

Serie / Series / Série

# SMP Glasgow



SMS P/PC  
SML P/PC \_\_\_\_\_ 350-351

Serie / Series / Série

# VEG Elegance



VEG \_\_\_\_\_ 352-353

Serie / Series / Série

# BIGGIE



VPG \_\_\_\_\_ 354-355

Serie / Series / Série

# MDCP Rotterdam



MS DCP/DCPC  
MN DCP/DCPC  
ML DCP/DCPC  
MS DCPI  
MN DCPI  
ML DCPI \_\_\_\_\_ 358-363

Serie / Series / Série

# MP Munich



MS P/PC  
MN P/PC  
ML P/PC  
MS PI  
MN PI  
ML PI \_\_\_\_\_ 364-369

Serie / Series / Série

# MSBA Oporto MSDCBA Orleans



MS BA  
MS DC BA \_\_\_\_\_ 370-371

Serie / Series / Série

# MDR Rimini



MN DR  
ML DR \_\_\_\_\_ 372-375

Serie / Series / Série

## MDG Portland



MS DG  
MN/MN22 DG  
ML/ML22 DG  
MX/MX22 DG 376-389

Serie / Series / Série

## MDGU Detroit



MS DGU  
MN DGU  
ML/ML22 DGU 390-397

Serie / Series / Série

## MPB Oslo



MN/MN22 PB  
ML/ML22 PB  
MX/MX22 PB 398-409

Serie / Series / Série

## MBT Toronto



MN/MN22 BT  
MF/MF22 BT 410-413

Serie / Series / Série

## MBTU Montreal



MN BTU 414-415

Serie / Series / Série

## MBTP Vancouver



MN BTP/BTPC 416-417

Serie / Series / Série

## Opciones Options Options

418-419

Serie / Series / Série

## Sigilus Intarbox Waterloop



Motocondensadoras  
Condensing Units  
Motocondensateurs 420-427

Serie / Series / Série

## Intarcube



Centrales Frigoríficas  
Refrigeration Units  
Centrales Frigorifiques 428-429



# 10. Murales Multidecks / Murales

Amplio rango dimensional para ofrecer la máxima capacidad.  
Wide dimensional range for maximum capacity.  
Une large gamme dimensionnelle pour offrir une capacité maximale.



**6** 625    **9** 938    **12** 1250    **18** 1875    **25** 2500    **31** 3125    **37** 3750

← Largo / Length / Longueur

**S: 685**    **N: 785**    **L: 885**    **F: 980**    **X: 1085**

↙ Ancho / Width / Largeur



**1075**    **1500**    **2000**    **2200**

↑ Alto / Height / Hauteur

Máxima visibilidad de producto expuesto.  
Maximum visibility of displayed product.  
Visibilité maximale du produit exposé.



## Iluminación / Lighting / Éclairage

Incorporación de iluminación LED, llegando a reducir el consumo energético entre un 80% y 90%, respecto a una bombilla tradicional. RGB opcional.

LED lighting incorporated, reducing energetic consumption between 80% and 90% respect to a traditional lighth bulb. RGB optional.

Éclairage LED, réduisant la consommation énergétique entre 80% et 90%, par rapport à une ampoule traditionnelle. RGB optionnel.



Rango completo de temperaturas.  
Full temperature range.  
Gamme de température complète.

T<sup>a</sup> Prod. | T<sup>a</sup> Aplic.

**M0: -1/+4°C | -1/+1°C** 🍷 🍹

**M1: -1/+5°C | 0/+2°C** 🍷 🍹 🍺 🍻

**M2: -1/+7°C | +2/+4°C** 🍷 🍹 🍺 🍻

**H1: +1/+10°C | +4/+6°C** 🍷 🍹

**L1: -15/-18°C | -23/-25°C** ❄️



+Info: [www.infrico.com](http://www.infrico.com)

**Estantes regulables e inclinables optimizados para cada ancho, mejorando la capacidad de carga sin reposiciones.**

Adjustable and tilting shelves optimised for each width, improving load capacity without repositioning.

Des étagères réglables et inclinables optimisées pour chaque largeur, améliorant la capacité de charge sans repositionnement.



**Amplias posibilidades de personalización: amplia gama de colores, laterales, accesorios...**

Extensive customisation possibilities: wide range of colours, sides, accessories...

Possibilités de personnalisation étendues : large gamme de couleurs, de côtés, d'accessoires...



Puertas / Doors / Portes

**SLIM**

**Puerta estándar de gran aislamiento**  
Standard door highly efficient  
Porte standard très isolée

**Cristales dobles templados, carga de Argón 90%, integración total, bisagras oleodinámicas, cierre automático 0-85°.**

Tempered double glass, Argon charge 90%, fully integrated, oleodynamic hinges, automatic closing 0-85°.

Double vitrage trempé, charge d'Argon 90%, intégration totale, charnières oléodynamiques, fermeture automatique 0-85°.

Puertas / Doors / Portes

**TOTAL LOOK**

**Cristal doble completamente transparente**  
Fully transparent double glass door  
Porte en verre double entièrement transparente

**Cristales dobles templados, carga de Argón 90%, integración total, bisagras oleodinámicas, cierre automático 0-85°.**

Tempered double glass, Argon charge 90%, fully integrated, oleodynamic hinges, automatic closing 0-85°.

Double vitrage trempé, charge d'Argon 90%, intégration totale, charnières oléodynamiques, fermeture automatique 0-85°.





# 10. Murales

## Multidecks / Murales

### Régimen de temperaturas / Temperature range / Régime de températures (ISO23953)

Tª Prod. | Tª Aplic.  
**M0: -1/+4°C | -1/+1°C**

 Carne / Meat / Viande

 Pescado / Fish / Poisson

Tª Prod. | Tª Aplic.  
**M1: -1/+5°C | 0/+2°C**

 Carne / Meat / Viande

 Pescado / Fish / Poisson

 4ª Gama / 4TH Range / 4ème Gamme

 Comida preparada / Grab & Go / Plats préparés

Tª Prod. | Tª Aplic.  
**M2: -1/+7°C | +2/+4°C**

 Charcutería / Deli / Charcuterie

 Bebidas / Cold drinks / Boissons

 Lacteos / Dairy / Laitiers

Tª Prod. | Tª Aplic.  
**H1: +1/+10°C | +4/+6°C**

 Lacteos / Dairy / Laitiers

 Frutas y verduras  
Fruit vegetables

 Fruits et légumes

Tª Prod. | Tª Aplic.  
**L1: -15/-18°C | -23/-25°C**

 Congelados

Frozen foods

Prod. Surgelés

### Puertas / Doors / Portes

#### Total Look

**Cristal doble completamente transparente**

Fully transparent double glass door

Porte en verre double entièrement transparente



**Cristales dobles templados, carga de Argón 90%, integración total, bisagras oleodinámicas, cierre automático 0-85°.**

Tempered double glass, Argon charge 90%, fully integrated, oleodynamic hinges, automatic closing 0-85°.

Double vitrage trempé, charge d'Argon 90%, intégration totale, charnières oléodynamiques, fermeture automatique 0-85°.

#### Slim

**Puerta estándar de gran aislamiento**

Standard door highly efficient

Porte standard très isolée



## Iluminación LED / LED lighting / Éclairage LED

**Los sistemas de iluminación de Infrico te ayudan a dar la máxima visibilidad del producto manteniendo su frescura y conservación.**

Infrico's lighting systems help you to give maximum product visibility while maintaining freshness and preservation.

Les systèmes d'éclairage d'Infrico vous permettent d'offrir une visibilité maximale du produit tout en maintenant la fraîcheur et la conservation.

**24V, Led vertical IP65, Led visera IP54, plug and play, temp. de color de 3000-4000-6000K en función del producto.**

24V, IP65 vertical LED, IP54 visor LED, plug and play, colour temperature 3000-4000-6000K depending on the product.

24V, LED verticale IP65, LED de visière IP54, plug and play, température de couleur 3000-4000-6000K selon le produit.



# Waterin

Sistema Waterloop R290 de Infrico

hasta  
**-25%**

Sistema eficiente, hasta el 25% de ahorro de energía.  
Efficient system with up to 25% energy saving.  
Système efficace avec jusqu'à 25 % d'économies d'énergie.

**-75%**

75% reducción carga refrigerante.  
75% refrigerant charge reduction.  
Réduction de 75 % de la charge de réfrigérant.

**0€**

Refrigerantes naturales SIN TASA.  
Natural refrigerants WITHOUT CHARGE.  
Réfrigérateurs naturels SANS TÂCHE.



Mínima carga refrigerante, aprox. 0.1kg/kw.  
Minimum refrigerant load, aprox. 0.1kg/kw.  
Charge minimale de réfrigérant, avec environ 0,1 Kg/kw de réfrigération.

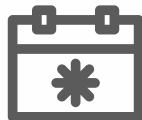

Flexibilidad de implantación.  
Flexibility of implementation.  
Flexibilité de mise en oeuvre.



Posibilidad de recuperación de calor en la instalación.  
Possibility of heat recovery in the installation.  
Possibilité de récupération de chaleur dans l'installation.



Condensadores sin mantenimiento.  
Maintenance-free condensers.  
Condensateurs de maintenance.



Posible eliminación de la sala de máquinas.  
Possible elimination of the machine room.  
Élimination possible, dans de nombreux cas, de la salle des machines.



Eliminación de riesgos típicos de inst. centralizadas.  
Elimination of the typical risks of central installations.  
Élimination des risques typiques des installations centralisées.



Menor riesgo de fugas.  
Reduced risk of leakage.  
Moins de risques de fuites.

+Info: [www.infrico.com](http://www.infrico.com)

El ahorro energético y el cuidado del medio ambiente son dos factores claves que han impulsado la iniciativa Waterin.

#### ¿Qué es Waterin?

Waterin son muebles de refrigeración comercial para la conservación de productos refrigerados y congelados, con unidades individuales R290 y sistema de condensación por agua.

#### ¿Dónde podemos instalar este sistema?

Este sistema es óptimo para instalaciones que cumplan los siguientes condicionantes:

- Sala de ventas de hasta 1400m<sup>2</sup> con aproximadamente hasta 40kW frigoríficos.
- Temperatura de trabajo exterior (DryCooler) máxima de 48°C.

#### ¿Este nuevo sistema requiere un proyecto de instalación?

El sistema Waterin no requiere instalación frigorífica porque son muebles con la unidad ya instalada y cargada desde fábrica, aunque su implantación requiere un cálculo de instalación para el dimensionado de las tuberías de agua, el DryCooler, el sistema hidráulico necesarios y su ubicación, etc.

#### Beneficios del sistema Waterin

Waterin por ser un sistema ecológico y de condensación por agua ofrece múltiples beneficios en la refrigeración comercial. Mayor eficiencia energética, menor impacto ambiental y mejor control de temperatura son sólo algunas de sus ventajas.



Saving energy and respect for the environment are two key factors that have driven the Waterin initiative.

#### What's Waterin?

Waterin are commercial refrigeration display cases for the preservation of refrigerated and frozen products, with individual R290 units and water condensation system.

#### Where do we install this system?

This system is ideal for installations that meet the following conditions:

- Supermarkets up to 1400m<sup>2</sup> with approximately up to 40kW of refrigeration capacity.
- Outdoor working temperature (DryCooler) max. 48°C.

#### Is an installation project required?

The Waterin system doesn't require refrigeration installation because it's display cases with the unit already installed and loaded from the factory, although its implementation requires an installation calculation for the dimensioning of the water pipes, the DryCooler, the necessary hydraulic system and its location, etc.

#### Benefits of Waterin

Waterin is an environmentally friendly, water condensing system that offers multiple benefits in commercial refrigeration. Greater energy efficiency, lower environmental impact and better temperature control are just some of its advantages.



Les économies d'énergie et le respect de l'environnement sont deux facteurs qui ont motivé l'initiative Waterin.

#### Qu'est-ce que Waterin?

Waterin est une armoire de réfrigération commerciale pour les températures positives et négatives de stockage des produits, avec des unités R290 individuelles et un système de condensation à l'eau.

#### Où peut-on installer ce système?

Ce système est optimal pour les installations qui répondent aux conditions suivantes :

- Salle de vente jusqu'à 1400 m<sup>2</sup> avec environ jusqu'à 40kW d'unités de réfrigération
- Température extérieure de travail (DryCooler) maximale de 48°C.

#### Ce nouveau système nécessite-t-il un projet d'installation?

Le système Waterin ne nécessite pas d'installation frigorifique car il s'agit d'un meuble avec l'unité déjà installée et chargée en usine, bien que sa mise en œuvre dans la salle de vente nécessite un calcul de l'installation du système de condensation de l'eau et de ses composants.

#### Quels sont les avantages du système Waterin ?

Waterin est un système écologique à condensation par eau qui offre de multiples avantages dans le domaine de la réfrigération commerciale. Une meilleure efficacité énergétique, un impact environnemental réduit et un meilleur contrôle de la température ne sont que quelques-uns de ses avantages.



# Waterin

## Sistema Waterloop R290 de Infrico

Unidades R290 condensados por agua de Temperatura Positiva.  
R290 units, Positive Temperature water condensed.  
Unités R290 à condensation par eau à Température Positive.

Unidades R290 condensados por agua de Temperatura Negativa.  
R290 units, Negative Temperature water condensed.  
Unités R290 à condensation par eau à Température négative.

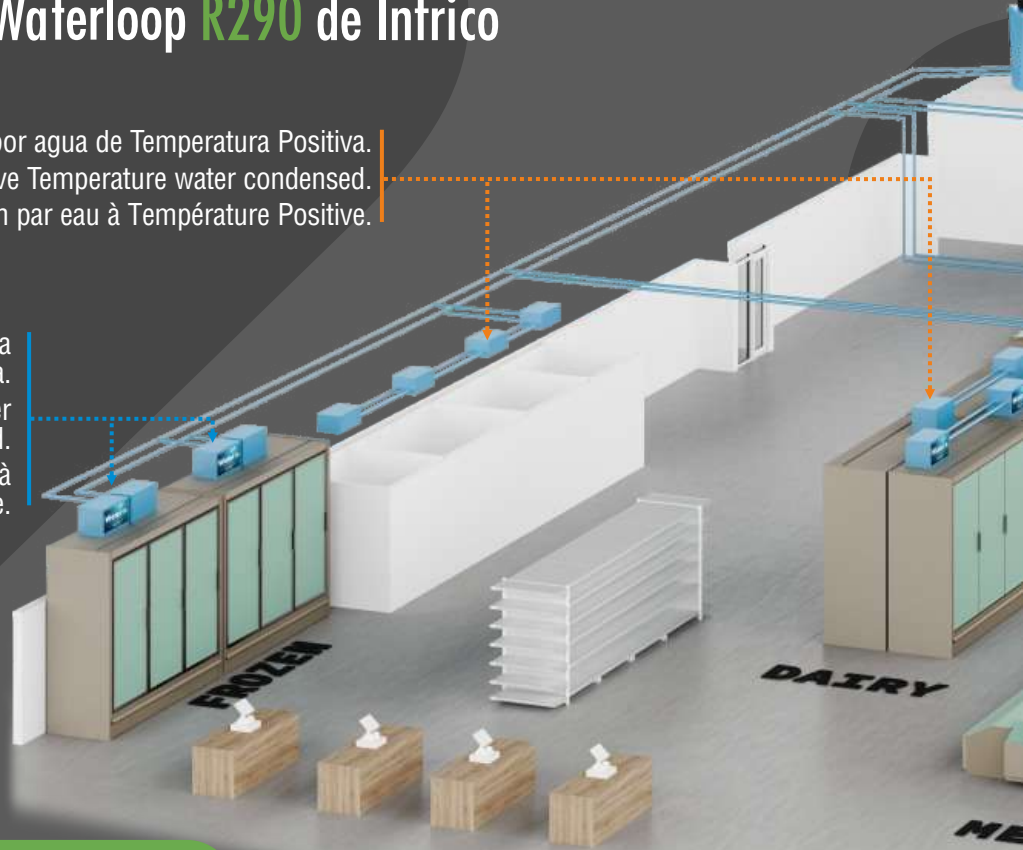

Posibilidad de recuperación de calor para calefacción o agua caliente sanitaria.

Possibility of heat recovery for heating or sanitary hot water.

Possibilité de récupération de chaleur pour le chauffage ou l'eau chaude sanitaire.

Unidades R290 condensados por agua de Temperatura Positiva.  
R290 units, Positive Temperature water condensed.  
Unités R290 à condensation par eau à Température Positive.



**MDGW**  
**MDGW22**

MS(12-18-25-37) DGW M1-M2-H1  
MN(12-18-25-37) DGW M1-M2-H1  
ML(12-18-25-37) DGW M1-M2-H1  
MN(12-18-25-37) DGW22 M1-M2-H1  
ML(12-18-25-37) DGW22 M1-M2-H1



**MBTW**

MN(2P-3P) BTW L1  
MN(2P-3P) BTW22 L1

10

+Info: [www.infrico.com](http://www.infrico.com)

Dry Coolers con grupo hidráulico.  
 Dry Coolers with hydraulic power unit.  
 Dry Coolers avec unité hydraulique.

Unidades R290 condensados por agua de Temperatura Negativa.  
 R290 units, Negative Temperature water condensed.  
 Unités R290 à condensation par eau à Température négative.

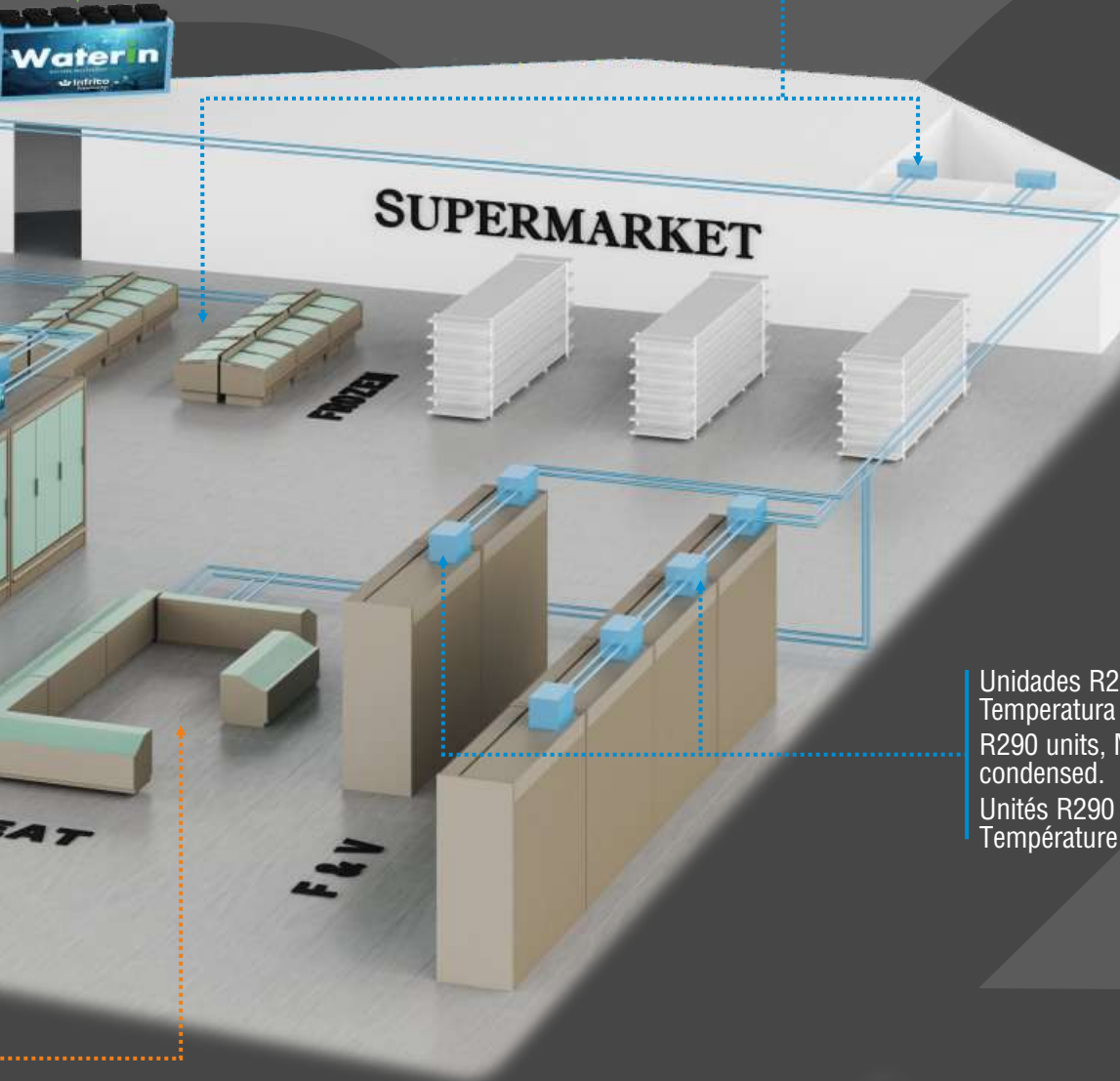

Unidades R290 condensados por agua de Temperatura Negativa.  
 R290 units, Negative Temperature water condensed.  
 Unités R290 à condensation par eau à Température négative.



**SEMIMURALES /  
LOW MULTIDECK DISPLAY CASES /  
VITRINES SEMI MURALES**







**Aceites y Salsas**  
**Arroces**  
**Cafés y Solubles**



# Semimural abierta y cerrada refrigerada grupo remoto

## Open and close refrigeration low multideck remote group

### Semi murale de réfrigération ouverte et fermée groupe à distance



MODELO MODELE MODÈLE	SMDG				SMPB																					
	SML12 DG M1	SML18 DG M1	SML25 DG M1	SML37 DG M1	SML12 PB M1	SML18 PB M1	SML25 PB M1	SML37 PB M1																		
Precio Price Prix	<b>M1</b>																									
MOD.	SML12 DG M2	SML18 DG M2	SML25 DG M2	SML37 DG M2	SML12 PB M2	SML18 PB M2	SML25 PB M2	SML37 PB M2																		
Precio Price Prix	<b>M2</b>																									
Medidas / Mesures / Mesures / [mm] Sin costados / Without sides / Sans joues	1250 x 904 x 1500 mm.	1875 x 904 x 1500 mm.	2500 x 904 x 1500 mm.	3750 x 904 x 1500 mm.	1250 x 904 x 1500 mm.	1875 x 904 x 1500 mm.	2500 x 904 x 1500 mm.	3750 x 904 x 1500 mm.																		
T°. Prod.   Aplic. Prod. T°.   Applic. T°. (°C) Temp. Prod.   Temp. Appliq.	<b>M1: -1/+5°C   0/+2°C</b> <b>M2: -1/+7°C   +2/+4°C</b>																									
Clase Climática Climatic class (°C) Classe climatique	3 / 25°C																									
Tensión/Frecuencia Electrical data Tension électrique	230V/1ph/50Hz																									
Controlador Controller Régulateur	Digital																									
Material Material Matériel [EXT/INT]	Acero galvanizado plastificado / Plastified galvanised steel / Acier galvanisé plastifié																									
Aislamiento Isolation Isolation [mm]	40kg/m <sup>3</sup> / Free CFC's / Zero ODP-GWP																									
Capacidad Capacity Capacité [L]	486	729	973	1459	486	729	973	1459																		
Superficie exposición Surface exhibition [x m <sup>2</sup> ] Surface d'exposition	1,17	1,76	2,34	3,52	1,49	2,23	2,97	4,46																		
Niveles Exposición Exposition Levels Niveaux d'exposition	3+Expos.																									
Costados [2] Sides [2] Joues [2] [mm]	40 + 40																									
Sistema de frío Cooling System Système de froid	Ventilado / Ventilated / Ventilé																									
Desescarche Defrost Dégivrage	Automático / Automatic / Automatique																									
Evaporación Evaporation Évaporation	Forzada / Forced / Ventilé																									
Potencia Power Puissance [W]	<b>M1</b> 80,5 <b>M2</b> 80,5	<b>M1</b> 121 <b>M2</b> 121	<b>M1</b> 161 <b>M2</b> 161	<b>M1</b> 242 <b>M2</b> 242	<b>M1</b> 80,5 <b>M2</b> 80,5	<b>M1</b> 121 <b>M2</b> 121	<b>M1</b> 161 <b>M2</b> 161	<b>M1</b> 242 <b>M2</b> 242																		
Potencia frig. Cooling capacity Puissance Frig. [W A -10°C]	<b>M1</b> 446 <b>M2</b> 338	<b>M1</b> 669 <b>M2</b> 581	<b>M1</b> 1339 <b>M2</b> 1163	<b>M1</b> 2121 <b>M2</b> 1803	<b>M1</b> 3188 <b>M2</b> 2704	<b>M1</b> 4243 <b>M2</b> 3605	<b>M1</b> 6364 <b>M2</b> 5408	<b>M1</b> 5438 <b>M2</b> 4624																		
Consumo Consumption Consommation [kWh/ 24h]	<b>M1</b> 1,35 <b>M2</b> 1,35	<b>M1</b> 2,03 <b>M2</b> 2,03	<b>M1</b> 2,70 <b>M2</b> 2,70	<b>M1</b> 4,06 <b>M2</b> 4,06	<b>M1</b> 1,35 <b>M2</b> 1,35	<b>M1</b> 2,03 <b>M2</b> 2,03	<b>M1</b> 2,70 <b>M2</b> 2,70	<b>M1</b> 4,06 <b>M2</b> 4,06																		
Refrigerante Refrigerant Gaz	<b>FREON</b>																									
Laterales / Sides / Joues	No Incluidos / Not includes / Non inclus																									
Colores estándar Standar colors Couleurs standard	<b>Int. Estándar / Standar / Standard</b> <table border="1"> <tr> <td>Blanco/White/ Blanc</td> <td>Negro/Black/ Noir</td> <td>Ral 7016</td> </tr> </table>								Blanco/White/ Blanc	Negro/Black/ Noir	Ral 7016															
Blanco/White/ Blanc	Negro/Black/ Noir	Ral 7016																								
Laterales disponibles Available sides Joues disponibles	<b>Ext. Estándar / Standar / Standard</b> <table border="1"> <tr> <td>Blanco/White/ Blanc</td> <td>Ral 1015</td> <td>Ral 1018</td> </tr> <tr> <td>Ral 2003</td> <td>Ral 3003</td> <td>Ral 3020</td> </tr> <tr> <td>Ral 5015</td> <td>Ral 5017</td> <td>Ral 5011</td> </tr> <tr> <td>Ral 6002</td> <td>Ral 6018</td> <td>Ral 6019</td> </tr> <tr> <td>Ral 7035</td> <td>Ral 7037</td> <td>Ral 7042</td> </tr> <tr> <td>Ral 7016</td> <td>Ral 9006</td> <td>Negro/Black/ Noir</td> </tr> </table>								Blanco/White/ Blanc	Ral 1015	Ral 1018	Ral 2003	Ral 3003	Ral 3020	Ral 5015	Ral 5017	Ral 5011	Ral 6002	Ral 6018	Ral 6019	Ral 7035	Ral 7037	Ral 7042	Ral 7016	Ral 9006	Negro/Black/ Noir
Blanco/White/ Blanc	Ral 1015	Ral 1018																								
Ral 2003	Ral 3003	Ral 3020																								
Ral 5015	Ral 5017	Ral 5011																								
Ral 6002	Ral 6018	Ral 6019																								
Ral 7035	Ral 7037	Ral 7042																								
Ral 7016	Ral 9006	Negro/Black/ Noir																								
Opciones pág. 426-427 Options pages 426-427 Options pages 426-427																										
	<p>Lateral Espejo Mirror end panels Joue Miroir</p>		<p>Lateral Panorámico Panoramic end panels Joue panoramique</p>		<p>Lateral Display Display end panels Joue Display</p>																					

Serie / Series / Série **SMDG (EDIMBURGO)**  
 Serie / Series / Série **SMPB (EDIMBURGO)**

+Info: [www.infrico.com](http://www.infrico.com)

SML25DG



SML25PB

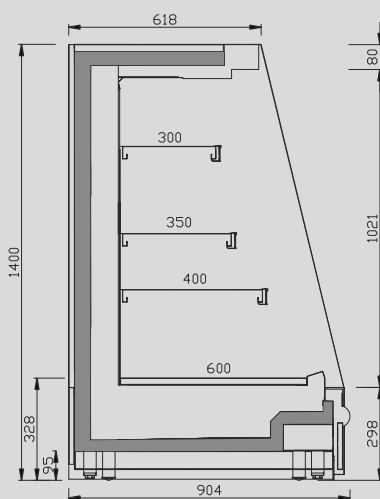

SML PB

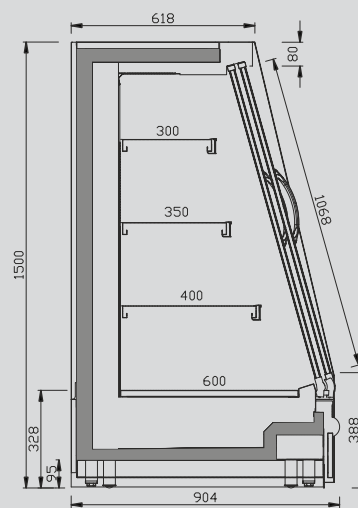

SML DG



# Semimural plug in de refrigeración cerradas

## Plug in refrigeration doors low multideck

### Semi murale de réfrigération fermée groupe incorporé



MODELO MODELE MODÈLE						
<b>Precio</b> Price Prix	<b>M1</b>					
<b>MOD.</b>	<b>SMS12 DCPC M1</b>	<b>SMS18 DCPC M1</b>	<b>SMS25 DCPC M1</b>	<b>SML12 DCPC M1</b>	<b>SML18 DCPC M1</b>	<b>SML25 DCPC M1</b>
<b>Precio</b> Price Prix	<b>C M1</b>					
<b>MOD.</b>	<b>SMS12 DCP M2</b>	<b>SMS18 DCP M2</b>	<b>SMS25 DCP M2</b>	<b>SML12 DCP M2</b>	<b>SML18 DCP M2</b>	<b>SML25 DCP M2</b>
<b>Precio</b> Price Prix	<b>M2</b>					
<b>MOD.</b>	<b>SMS12 DCPC M2</b>	<b>SMS18 DCPC M2</b>	<b>SMS25 DCPC M2</b>	<b>SML12 DCPC M2</b>	<b>SML18 DCPC M2</b>	<b>SML25 DCPC M2</b>
<b>Precio</b> Price Prix	<b>C M2</b>					
<b>Medidas / Mesures /</b> Mesures / [mm] <b>Sin costados / Without</b> sides / Sans joues	1250 x 685 x 1500 mm.	1875 x 685 x 1500 mm.	2500 x 685 x 1500 mm.	1250 x 885 x 1500 mm.	1875 x 885 x 1500 mm.	2500 x 885 x 1500 mm.
<b>T°. Prod.   Aplic.</b> Prod. T°.   Applic. T°. (°C) Temp. Prod.   Temp. Appliq.	<b>M1: -1/+5°C   0/+2°C</b> <b>M2: -1/+7°C   +2/+4°C</b>					
<b>Clase Climática</b> Climatic class (°C) Classe climatique	3 / 25°C					
<b>Tensión/Frecuencia</b> Electrical data Tension électrique	230V/1ph/50Hz					
<b>Controlador</b> Controller Régulateur	Digital					
<b>Material</b> Material (EXT/INT) Matériel	Acero galvanizado plastificado / Plastified galvanised steel / Acier galvanisé plastifié					
<b>Aislamiento</b> Isolation [mm] Isolation	40kg/m <sup>3</sup> / Free CFC's / Zero ODP-GWP					
<b>Capacidad</b> Capacity (L) Capacité	263	396	528	345	518	690
<b>Superficie exposición</b> Surface exhibition [x m <sup>2</sup> ] Surface d'exposition	1,14	1,72	2,08	1,20	2,10	2,80
<b>Niveles Exposición</b> Exposition Levels Niveaux d'exposition	3+Expos.					
<b>Costados (2)</b> Sides (2) [mm] Joues (2)	40 + 40					
<b>Puertas</b> Doors Portes	2		4		2	4
<b>Sistema de frío</b> Cooling System Système de froid	Ventilado / Ventilated / Ventilé					
<b>Desescarche</b> Defrost Dégivrage	Automático / Automatic / Automatique					
<b>Evaporación</b> Evaporation Évaporation	Forzada / Forced / Ventilé					
<b>Potencia</b> Power (W) Puissance	<b>M1 537</b> <b>M2 537</b>	<b>M1 725</b> <b>M2 725</b>	<b>M1 1116</b> <b>M2 1116</b>	<b>M1 537</b> <b>M2 537</b>	<b>M1 700</b> <b>M2 700</b>	<b>M1 1116</b> <b>M2 1116</b>
<b>Potencia frig.</b> Cooling capacity (W A -10°C) Puissance Frig.	-					
<b>Consumo</b> Consumption (kWh/ 24h) Consommation	<b>M1 8,18</b> <b>M2 7,87</b>	<b>M1 10,7</b> <b>M2 10,3</b>	<b>M1 15,1</b> <b>M2 14,1</b>	<b>M1 8,93</b> <b>M2 7,87</b>	<b>M1 11,0</b> <b>M2 10,3</b>	<b>M1 15,8</b> <b>M2 15,3</b>
<b>Refrigerante</b> Refrigerant Gaz	<b>R-290</b>					
<b>Colores estándar</b> Standard colors Couleurs standard	<b>Ext. Estándar / Standar / Standard</b>		<b>Laterales / Sides / Joues</b>			
	Blanco/White/ Blanc	Ral 1015	Ral 1018	No Incluidos / Not includes / Non inclus		
	Ral 2003	Ral 3003	Ral 3020			
<b>Laterales disponibles</b> Available sides Joues disponibles	Ral 5015	Ral 5017	Ral 5011	<b>Int. Estándar / Standar / Standard</b>		
	Ral 6002	Ral 6018	Ral 6019	Blanco/White/ Blanc	Negro/Black/ Noir	Ral 7016
	Ral 7035	Ral 7037	Ral 7042			
<b>Opciones pág. 426-427</b> Options pages 426-427 Options pages 426-427	Ral 7016	Ral 9006	Negro/Black/ Noir			

10

Serie / Series / Série **SMDCP (DUBLÍN)**

+Info: [www.infrico.com](http://www.infrico.com)

SML25DCP

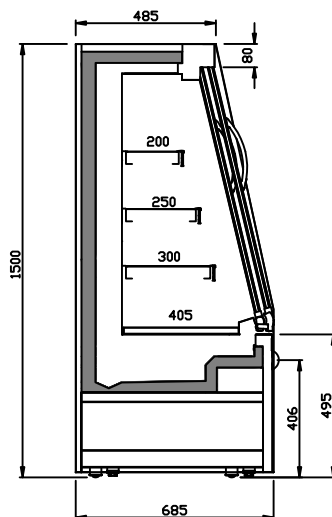
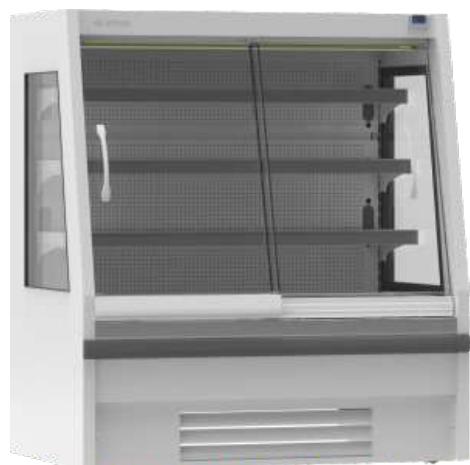

SMS DCP

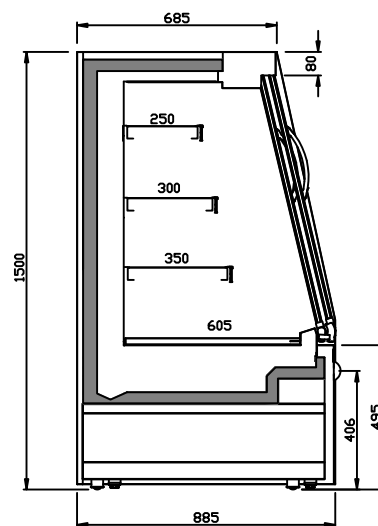

SML DCP

SMS12DCP





# Semimural plug in de refrigeración abiertas

## Plug in refrigeration open low multideck

### Semi murale de réfrigération ouverte groupe incorporé



MODELO MODEL MODÈLE	SMS					SML				
	SMS6 P M2	SMS9 P M2	SMS12 P M2	SMS18 P M2	SMS25 P M2	SML6 P M2	SML9 P M2	SML12 P M2	SML18 P M2	SML25 P M2
Precio Price Prix	M2									
MOD.	SMS6 PC M2	SMS9 PC M2	SMS12 PC M2	SMS18 PC M2	SMS25 PC M2	SML6 PC M2	SML9 PC M2	SML12 PC M2	SML18 PC M2	SML25 PC M2
Precio Price Prix	C M2									
Medidas / Mesures / Mesures / [mm] Sin costados / Without sides / Sans joues	625 x 685 x 1500 mm.	938 x 685 x 1500 mm.	1250 x 685 x 1500 mm.	1875 x 685 x 1500 mm.	2500 x 685 x 1500 mm.	625 x 885 x 1500 mm.	938 x 885 x 1500 mm.	1250 x 885 x 1500 mm.	1875 x 885 x 1500 mm.	2500 x 885 x 1500 mm.
T°. Prod.   Aplic. Prod. T°.   Applic. T°. (°C) Temp. Prod.   Temp. Appliq.	M2: -1/+7°C   +2/+4°C									
Clase Climática Climatic class (°C) Classe climatique	3 / 25°C									
Tensión/Frecuencia Electrical data Tension électrique	230V/1ph/50Hz									
Controlador Controller Régulateur	Digital									
Material Material Matériel [EXT/INT]	Acero galvanizado plastificado / Plastified galvanised steel / Acier galvanisé plastifié									
Aislamiento Isolation Isolation [mm]	40kg/m <sup>3</sup> / Free CFC's / Zero ODP-GWP									
Capacidad Capacity Capacité [L]	63	95	127	190	253	179	269	358	537	716
Superficie exposición Surface exhibition Surface d'exposition [x m <sup>2</sup> ]	0,82	1,22	1,63	2,45	3,26	0,94	1,41	1,88	2,82	3,76
Niveles Exposición Exposition Levels Niveaux d'exposition	3+Expos.									
Costados [2] Sides [2] Joues [2] [mm]	40 + 40									
Puertas Doors Portes	-									
Sistema de frío Cooling System Système de froid	Ventilado / Ventilated / Ventilé									
Desescarche Defrost Dégivrage	Automático / Automatic / Automatique									
Evaporación Evaporation Évaporation	Forzada / Forced / Ventilé									
Potencia Power Puissance [W]	461	599	609	1031	1331	461	599	609	1031	1331
Potencia frig. Cooling capacity Puissance Frig. [W A -10°C]	-									
Consumo Consumption Consommation [kWh/ 24h]	7,2	9,6	9,8	10,1	18,5	7,6	11,2	11,8	16,3	19,0
Refrigerante Refrigerant Gaz	R-290									
Colores estándar Standar colors Couleurs standard	<b>Int. Estándar / Standar / Standard</b> Blanco/White/ Blanc Negro/Black/ Noir Ral 7016			<b>Laterales / Sides / Joues</b> No Incluidos / Not includes / Non inclus						
Laterales disponibles Available sides Joues disponibles	<b>Ext. Estándar / Standar / Standard</b> Blanco/White/ Blanc Ral 1015 Ral 1018 Ral 2003 Ral 3003 Ral 3020 Ral 5015 Ral 5017 Ral 5011 Ral 6002 Ral 6018 Ral 6019 Ral 7035 Ral 7037 Ral 7042 Ral 7016 Ral 9006 Negro/Black/ Noir			 						
Opciones pág. 426-427 Options pages 426-427 Options pages 426-427										



Serie / Series / Série **SMP (GLASGOW)**

+Info: [www.infrico.com](http://www.infrico.com)

SMS18P C



SML18P

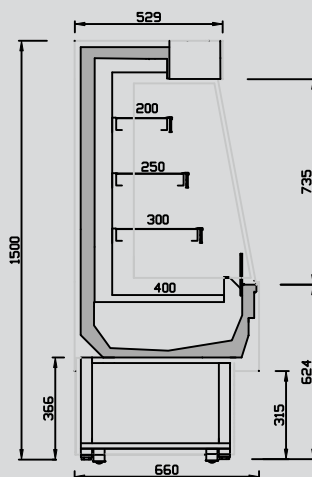

SMS P

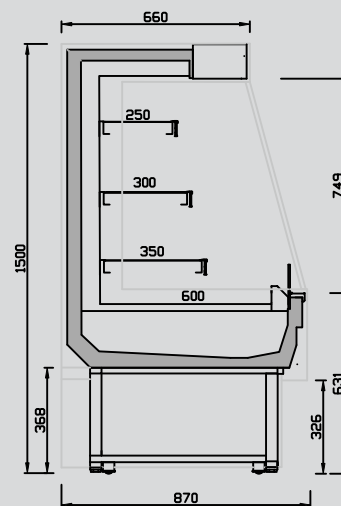

SML P







# Semimural plug in R-290 de refrigeración abierta, estética vitrina

## Closed plug in refrigeration low multideck, aesthetically display case

### Semi murale de réfrigération R-290 groupe incorporé, esthétique vitrine

1075

MODELO MODELE MODÈLE				
Precio Price Prix	<b>U</b>			
MOD.	<b>VEG9IU</b>	<b>VEG12IU</b>	<b>VEG15IU</b>	<b>VEG18IU</b>
Precio Price Prix	<b>IU</b>			
Medidas Measures Mesures (mm)	938 x 1075 x 1260 mm.	1250 x 1075 x 1260 mm.	1562 x 1075 x 1260 mm.	1875 x 1075 x 1260 mm.
T°. Prod.   Aplic. Prod. T°.   Applic. T°. (°C) Temp. Prod.   Temp. Appliq.	<b>M2: -1/+7°C   +2/+4°C</b>			
Clase Climática Climatic class Classe climatique (°C)	3 / 25°C			
Tensión/Frecuencia Electrical data Tension électrique	230V/1ph/50Hz			
Controlador Controller Régulateur	Digital			
Material Material Matériel (EXT/INT)	Ext/Int: Acero galvanizado plastificado / Plastified galvanised steel / Acier galvanisé plastifié Int: Inox AISI 304 (mod. I)			
Aislamiento Isolation Isolation (mm)	40kg/m <sup>3</sup> / Free CFC's / Zero ODP-GWP			
Capacidad Capacity Capacité (L)	316	425	531	638
Superficie exposición Surface exhibition Surface d'exposition (x m <sup>2</sup> )	0,83	1,12	1,39	1,67
Compresor Compressor Compresseur (HP)	3/4	3/4	1	1+1/4
Estantes Shelving Étagères	-			
Costados (2) Sides (2) Joues (2) (mm)	30+30			
Sistema de frío Cooling System Système de froid	Ventilado / Ventilated / Ventilé			
Desescarche Defrost Dégivrage	Automático / Automatic / Automatique			
Evaporación Evaporation Évaporation	Forzada / Forced / Ventilé			
Potencia Power Puissance (W)	595	741	838	1229
Potencia frig. Cooling capacity Puissance Frig. (W A -10°C)	-			
Consumo Consumption Consommation (kWh/ 24h)	7,85	9,8	11,1	14,8
Refrigerante Refrigerant Gaz	<b>R-290</b>			
Colores estándar Standar colors Couleurs standard	<b>Int. Estándar / Standar / Standard</b> Blanco/White/Blanc    Negro/Black/Noir		<b>Laterales / Sides / Joues</b> No Incluidos / Not includes / Non inclus	
Laterales disponibles Available sides Joues disponibles	<b>Ext. Estándar / Standar / Standard</b> Blanco/White/Blanc    Ral 1001    Ral 1018 Ral 2003    Ral 3003    Ral 3020 Design 2108025    Ral 5015    Ral 4007 Ral 6002    Design 1107060    Design 3504035 Ral 9006    Ral 7016    Ral 8017			
Opciones pág. 426-427 Options pages 426-427 Options pages 426-427				

10



Serie / Series / Série **VEG (ELEGANCE)**

+Info: [www.infrico.com](http://www.infrico.com)

VEG18



VEG15

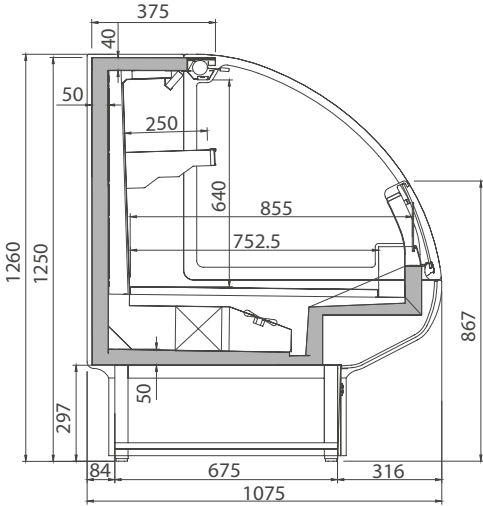

VEG



# Isla promocional autoservicio

## Self-service promotional island

### Îlot promotionnel en libre-service



MODELO  
MODELE  
MODÈLE

<b>Precio</b> Price Prix	
<b>Medidas</b> Measures [mm] Mesures	3600 x 1895 x 1735 mm.
<b>T°. Prod.   Aplic.</b> Prod. T°.   Applic. T°. [°C] Temp. Prod.   Temp. Appliq.	<b>M2: -1/+7°C</b>
<b>Clase Climática</b> Climatic class Classe climatique [°C]	3 / 25°C
<b>Tensión/Frecuencia</b> Electrical data Tension électrique	230V/1ph/50Hz
<b>Controlador</b> Controller Régulateur	Digital
<b>Material</b> Material [EXT/INT] Matériel	EXT: Acero negro y madera de roble natural / Black stainless and natural oak wood / Acier noir et bois de chêne naturel INT: Acero negro / Black stainless / Acier noir
<b>Aislamiento</b> Isolation [mm]	40kg/m <sup>3</sup> / Free CFC's / Zero ODP-GWP
<b>Capacidad</b> Capacity [L] Capacité	1026
<b>Superficie exposición</b> Surface exhibition [x m <sup>2</sup> ] Surface d'exposition	7,98
<b>Compresor</b> Compressor [HP] Compresseur	1 + 1 + 1 1/2 + 1 1/2
<b>Niveles Exposición</b> Exposition Levels Niveaux d'exposition	3
<b>Costados [2]</b> Sides [2] [mm] Joues [2]	40+40
<b>Sistema de frío</b> Cooling System Système de froid	Ventilado / Ventilated / Ventilé
<b>Desescarche</b> Defrost Dégivrage	Automático / Automatic / Automatique
<b>Evaporación</b> Evaporation Évaporation	Forzada / Forced / Ventilé
<b>Potencia</b> Power [W] Puissance	2x746 + 2x1112
<b>Potencia frig.</b> Cooling capacity [W A -10°C] Puissance Frig.	-
<b>Consumo</b> Consumption [kWh/ 24h] Consommation	2x5,21 + 2x7,53
<b>Refrigerante</b> Refrigerant Gaz	<b>R-290</b>
<b>Colores estándar</b> Standar colors Couleurs standard	
<b>Laterales disponibles</b> Available sides Joues disponibles	-
<b>Opciones pág. 426-427</b> Options pages 426-427 Options pages 426-427	

Serie / Series / Série **VPG (BIGGIE)**

+Info: [www.infrico.com](http://www.infrico.com)

VPG37 (2xVGG18UCB + 2xMGG18PM2)

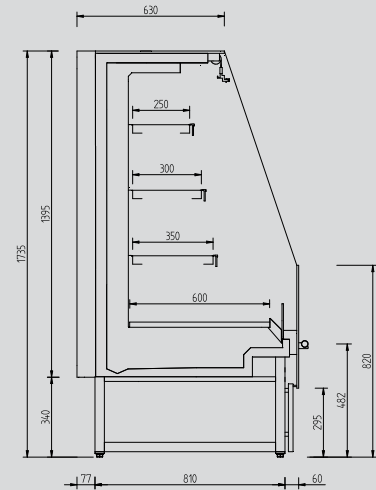
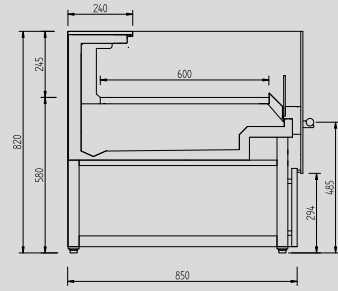

**MURALES /  
VERTICAL MULTIDECK DISPLAY CASES /  
MURALES**





# Mural plug in de refrigeración cerrada

## Plug in refrigeration doors multidecks

### Murale de réfrigération fermée groupe incorporé



MODELO MODELE MODÈLE					
<b>Precio</b> Price Prix	<b>M1 / C M1</b>				
<b>MOD.</b>	<b>MS6 DCP M2 / DCPC M2</b>				
<b>Precio</b> Price Prix	<b>M2 / C M2</b>				
<b>MOD.</b>	<b>MS9 DCP H1 / DCPC H1</b>				
<b>Precio</b> Price Prix	<b>H1 / C H1</b>				
<b>MOD.</b>	<b>MS9 DCPI M1 / DCPI M2</b>				
<b>Precio</b> Price Prix	<b>INOX M1 / M2</b>				
<b>Medidas</b> Measures (mm) Mesures	625 x 685 x 2000 mm.	938 x 685 x 2000 mm.	1250 x 685 x 2000 mm.	1875 x 685 x 2000 mm.	2500 x 685 x 2000 mm.
<b>Tª. Prod.   Aplic.</b> Prod. Tª.   Applic. Tª. (°C) Temp. Prod.   Temp. Appliq.	<b>M1: -1/+5°C   0/+2°C</b>				
<b>Clase Climática</b> Climatic class (°C) Classe climatique	3 / 25°C				
<b>Tensión/Frecuencia</b> Electrical data Tension électrique	230V/1ph/50Hz				
<b>Controlador</b> Controller Régulateur	Digital				
<b>Material</b> Material [EXT/INT] Matériel	Acero galvanizado plastificado / Plastified galvanised steel / Acier galvanisé plastifié				
<b>Aislamiento</b> Isolation (mm) Isolation	40kg/m³ / Free CFC's / Zero ODP-GWP				
<b>Capacidad</b> Capacity (L) Capacité	M1, M2: 230 H1: 184	M1, M2: 341 H1: 278	M1, M2: 455 H1: 370	M1, M2: 683 H1: 555	M1, M2: 910 H1: 740
<b>Superficie exposición</b> Surface exhibition (x m²) Surface d'exposition	M1, M2: 0,80 H1: 0,80	M1, M2: 1,11 H1: 1,11	M1, M2: 1,45 H1: 1,45	M1, M2: 2,17 H1: 2,17	M1, M2: 2,90 H1: 2,90
<b>Niveles Exposición</b> Exposition Levels Niveaux d'exposition	M1-M2: 4+Expos. H1: 3+Expos.				
<b>Costados [2]</b> Sides [2] (mm) Joues [2]	40 + 40				
<b>Puertas</b> Doors Portes	1	2	2	3	4
<b>Sistema de frío</b> Cooling System Système de froid	Ventilado / Ventilated / Ventilé				
<b>Desescarche</b> Defrost Dégivrage	Automático / Automatic / Automatique				
<b>Evaporación</b> Evaporation Evaporation	Forzada / Forced / Ventilé				
<b>Potencia</b> Power (W) Puissance	M1: 539 H1: 539	M1: 626 H1: 672	M1: 714 H1: 770	M1: 837 H1: 899	M1: 2164 H1: 2374
<b>Potencia frig.</b> Cooling capacity (W A -10°C) Puissance Frig.	-				
<b>Consumo</b> Consumption (kWh/24h) Consommation	M1: 7,86 H1: 5,99	M1: 8,89 H1: 7,27	M1: 9,88 H1: 8,62	M1: 12,81 H1: 10,74	M1: 17,10 H1: 14,08
<b>Refrigerante</b> Refrigerant Gaz	<b>R-290</b>				
<b>Colores estándar</b> Standar colors Couleurs standard	<b>Ext. Estándar / Standar / Standard</b>		<b>Laterales / Sides / Joues</b>		
	Blanco/White/ Blanc	Ral 1015	Ral 1018	No incluidos / Not includes / Non inclus	
	Ral 2003	Ral 3003	Ral 3020		
<b>Laterales disponibles</b> Available sides Joues disponibles	Ral 5015	Ral 5017	Ral 5011	<b>Int. Estándar / Standar / Standard</b>	
	Ral 6002	Ral 6018	Ral 6019	Blanco/White/ Blanc	Negro/Black/ Noir
	Ral 7035	Ral 7037	Ral 7042	Ral 7016	
<b>Opciones pág. 426-427</b> Options pages 426-427 Options pages 426-427	Ral 7016	Ral 9006	Negro/Black/ Noir		



Serie / Series / Série **MDCP (ROTTERDAM)**

+Info: [www.infrico.com](http://www.infrico.com)

MS25 DCPC M2



**Nuevo  
paragolpes  
frontal**

**New  
front  
bumper**

**Nouveau  
pare-chocs  
frontale**



MS18 DCPI M1

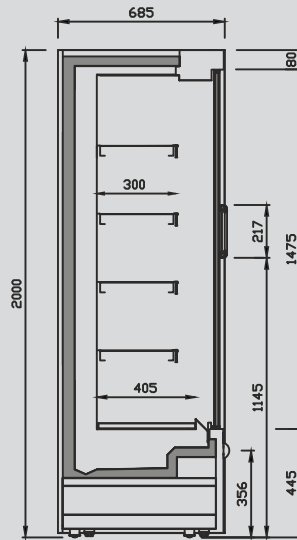

MS DCP M1/M2

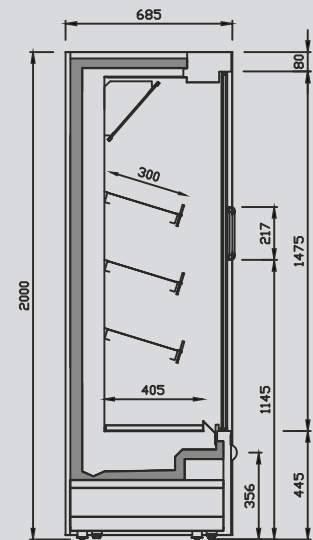

MS DCP H1





Los datos técnicos están sujetos a posibles variaciones que se actualizarán periódicamente en las fichas técnicas de los productos disponibles en la web /  
The technical data are subject to possible variations that will be updated periodically in the technical data sheets of the products which are available on the website /  
Les données techniques peuvent varier et seront actualisées dans les fiches techniques des produits disponibles sur le site.

# Mural plug in de refrigeración cerrada

## Plug in refrigeration doors multidecks

### Murale de réfrigération fermée groupe incorporé

N: 785

MODELO MODEL MODÈLE	MN9 DCP M1 / DCPC M1	MN12 DCP M1 / DCPC M1	MN18 DCP M1 / DCPC M1	MN25 DCP M1 / DCPC M1
<b>Precio Price Prix</b> <b>M1 / C M1</b>				
<b>MOD.</b>	<b>MN9 DCP M2 / DCPC M2</b>	<b>MN12 DCP M2 / DCPC M2</b>	<b>MN18 DCP M2 / DCPC M2</b>	<b>MN25 DCP M2 / DCPC M2</b>
<b>Precio Price Prix</b> <b>M2 / C M2</b>				
<b>MOD.</b>	<b>MN9 DCP H1 / DCPC H1</b>	<b>MN12 DCP H1 / DCPC H1</b>	<b>MN18 DCP H1 / DCPC H1</b>	<b>MN25 DCP H1 / DCPC H1</b>
<b>Precio Price Prix</b> <b>H1 / C H1</b>				
<b>MOD.</b>	<b>MN9 DCPI M1 / DCPI M2</b>	<b>MN12 DCPI M1 / DCPI M2</b>	<b>MN18 DCPI M1 / DCPI M2</b>	-
<b>Precio Price Prix</b> <b>INOX M1 / M2</b>				
<b>Medidas Measures Mesures</b> (mm)	938 x 785 x 2000 mm.	1250 x 785 x 2000 mm.	1875 x 785 x 2000 mm.	2500 x 785 x 2000 mm.
<b>Tª. Prod.   Aplic. Prod. Tª.   Applic. Tª. (°C) Temp. Prod.   Temp. Appliq.</b>	<b>M1: -1/+5°C   0/+2°C M2: -1/+7°C   +2/+4°C H1: +1/+10°C   +4/+6°C</b>			
<b>Clase Climática Climatic class Classe climatique</b> (°C)	3 / 25°C			
<b>Tensión/Frecuencia Electrical data Tension électrique</b>	230V/1ph/50Hz			
<b>Controlador Controller Régulateur</b>	Digital			
<b>Material Material Matériel</b> [EXT/INT]	Acero galvanizado plastificado / Plastified galvanised steel / Acier galvanisé plastifié			
<b>Aislamiento Isolation Isolation</b> (mm)	40kg/m³ / Free CFC's / Zero ODP-GWP			
<b>Capacidad Capacity Capacité</b> (L)	M1, M2: 394 H1: 319	M1, M2: 526 H1: 426	M1, M2: 789 H1: 639	M1, M2: 1053 H1: 852
<b>Superficie exposición Surface exhibition Surface d'exposition</b> (x m²)	M1, M2: 1,97 H1: 1,60	M1, M2: 2,63 H1: 2,10	M1, M2: 3,95 H1: 3,20	M1, M2: 5,30 H1: 4,20
<b>Niveles Exposición Exposition Levels Niveaux d'exposition</b>	M1-M2: 4+Expos. H1: 3+Expos.			
<b>Costados [2] Sides [2] Jous [2]</b> (mm)	40 + 40			
<b>Puertas Doors Portes</b>	2	2	3	4
<b>Sistema de frío Cooling System Système de froid</b>	Ventilado / Ventilated / Ventilé			
<b>Desescarche Defrost Dégivrage</b>	Automático / Automatic / Automatique			
<b>Evaporación Evaporation Evaporation</b>	Forzada / Forced / Ventilé			
<b>Potencia Power Puissance</b> (W)	M1: 626 M2: 672 H1: 672	M1: 714 M2: 770 H1: 770	M1: 837 M2: 899 H1: 899	M1: 1192 M2: 1297 H1: 1297
<b>Potencia frig. Cooling capacity Puissance Frig.</b> (W A -10°C)	-			
<b>Consumo Consumption Consommation</b> (kWh/24h)	M1: 8.09 M2: 7.54 H1: 6.07	M1: 8.99 M2: 8.38 H1: 7.10	M1: 15.59 M2: 9.53 H1: 8.57	M1: 16.56 M2: 14.91 H1: 13.41
<b>Refrigerante Refrigerant Gaz</b>	<b>R-290</b>			
<b>Colores estándar Standard colors Couleurs standard</b>	<b>Ext. Estándar / Standar / Standard</b>		<b>Laterales / Sides / Jous</b>	
	Blanco/White/Blanc	Ral 1015 Ral 1018	No incluidos / Not includes / Non inclus	
	Ral 2003	Ral 3003 Ral 3020		
<b>Laterales disponibles Available sides Jous disponibles</b>	Ral 5015	Ral 5017 Ral 5011	<b>Int. Estándar / Standar / Standard</b>	
	Ral 6002	Ral 6018 Ral 6019	Blanco/White/Blanc Negro/Black/Noir Ral 7016	
	Ral 7035	Ral 7037 Ral 7042		
<b>Opciones pág. 426-427 Options pages 426-427 Options pages 426-427</b>	Ral 7016	Ral 9006 Negro/Black/Noir		
				

10



Serie / Series / Série **MDCP (ROTTERDAM)**

+Info: [www.infrico.com](http://www.infrico.com)

MN25 DCPC M2



**Nuevo  
paragolpes  
frontal**

**New  
front  
bumper**

**Nouveau  
pare-chocs  
frontale**



MN25 DCP H1

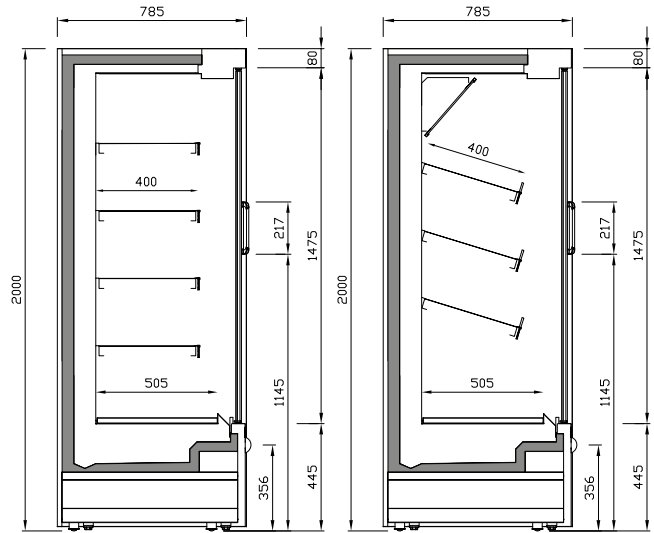

MN DCP M1/M2

MN DCP H1



están sujetos a cambios sin previo aviso. Los precios y disponibilidad de los productos, disponibles en línea y en tienda. Les prix et disponibilité des produits, disponibles sur le site web. Prices and availability of the products, available on the website. Preços e disponibilidade dos produtos, disponíveis no site web.

# Mural plug in de refrigeración cerrada

## Plug in refrigeration doors multidecks

### Murale de réfrigération fermée groupe incorporé



MODELO MODELE MODÈLE				
<b>Precio Price Prix</b> <b>M1 / C M1</b>				
<b>MOD.</b>	<b>ML9 DCP M2 / DCPC M2</b>	<b>ML12 DCP M2 / DCPC M2</b>	<b>ML18 DCP M2 / DCPC M2</b>	<b>ML25 DCP M2 / DCPC M2</b>
<b>Precio Price Prix</b> <b>M2 / C M2</b>				
<b>MOD.</b>	<b>MI9 DCP H1 / DCPC H1</b>	<b>ML12 DCP H1 / DCPC H1</b>	<b>ML18 DCP H1 / DCPC H1</b>	<b>ML25 DCP H1 / DCPC H1</b>
<b>Precio Price Prix</b> <b>H1 / C H1</b>				
<b>MOD.</b>	<b>ML9 DCPI M1 / DCPI M2</b>	<b>ML12 DCPI M1 / DCPI M2</b>	<b>ML18 DCPI M1 / DCPI M2</b>	-
<b>Precio Price Prix</b> <b>INOX M1 / M2</b>				-
<b>Medidas Measures Mesures</b> (mm)	938 x 885 x 2000 mm.	1250 x 885 x 2000 mm.	1875 x 885 x 2000 mm.	2500 x 885 x 2000 mm.
<b>Tª. Prod.   Aplic. Prod. Tª.   Applic. Tª. (°C) Temp. Prod.   Temp. Appliq.</b>	<b>M1: -1/+5°C   0/+2°C M2: -1/+7°C   +2/+4°C H1: +1/+10°C   +4/+6°C</b>			
<b>Clase Climática Climatic class Classe climatique</b> (°C)	3 / 25°C			
<b>Tensión/Frecuencia Electrical data Tension électrique</b>	230V/1ph/50Hz			
<b>Controlador Controller Régulateur</b>	Digital			
<b>Material Material Matériel</b> [EXT/INT]	Acero galvanizado plastificado / Plastified galvanised steel / Acier galvanisé plastifié			
<b>Aislamiento Isolation Isolation</b> (mm)	40kg/m³ / Free CFC's / Zero ODP-GWP			
<b>Capacidad Capacity Capacité</b> (L)	M1, M2: 414 H1: 339	M1, M2: 551 H1: 451	M1, M2: 827 H1: 677	M1, M2: 1103 H1: 903
<b>Superficie exposición Surface exhibition Surface d'exposition</b> (x m²)	M1, M2: 2,07 H1: 1,70	M1, M2: 2,80 H1: 2,30	M1, M2: 4,10 H1: 3,40	M1, M2: 5,50 H1: 4,50
<b>Niveles Exposición Exposition Levels Niveaux d'exposition</b>	M1-M2: 4+Expos. H1: 3+Expos.			
<b>Costados [2] Sides [2] Jous [2]</b> (mm)	40 + 40			
<b>Puertas Doors Portes</b>	2	2	3	4
<b>Sistema de frío Cooling System Système de froid</b>	Ventilado / Ventilated / Ventilé			
<b>Desescarche Defrost Dégivrage</b>	Automático / Automatic / Automatique			
<b>Evaporación Evaporation Évaporation</b>	Forzada / Forced / Ventilé			
<b>Potencia Power Puissance</b> (W)	M1: 627 M2: 672 H1: 673	M1: 714 M2: 770 H1: 770	M1: 837 M2: 899 H1: 899	M1: 1192 M2: 1297 H1: 1297
<b>Potencia frig. Cooling capacity Puissance Frig.</b> (W A -10°C)	-			
<b>Consumo Consumption Consommation</b> (kWh/24h)	M1: 8.09 M2: 7.54 H1: 6.07	M1: 9.34 M2: 8.38 H1: 7.10	M1: 10.59 M2: 9.53 H1: 8.57	M1: 16.56 M2: 14.91 H1: 13.41
<b>Refrigerante Refrigerant Gaz</b>	<b>R-290</b>			
<b>Colores estándar Standard colors Couleurs standard</b>	<b>Ext. Estándar / Standar / Standard</b> Blanco/White/Blanc Ral 1015 Ral 1018 Ral 2003 Ral 3003 Ral 3020		<b>Laterales / Sides / Jous</b> No incluidos / Not includes / Non inclus	
<b>Laterales disponibles Available sides Jous disponibles</b>	Ral 5015 Ral 5017 Ral 5011 Ral 6002 Ral 6018 Ral 6019 Ral 7035 Ral 7037 Ral 7042 Ral 7016 Ral 9006 Negro/Black/Noir		<b>Int. Estándar / Standar / Standard</b> Blanco/White/Blanc Negro/Black/Noir Ral 7016	
<b>Opciones pág. 426-427 Options pages 426-427 Options pages 426-427</b>				



Serie / Series / Série **MDCP (ROTTERDAM)**

+Info: [www.infrico.com](http://www.infrico.com)

ML25 DCPC M2



**Nuevo  
paragolpes  
frontal**

**New  
front  
bumper**

**Nouveau  
pare-chocs  
frontale**



ML25 DCP H1

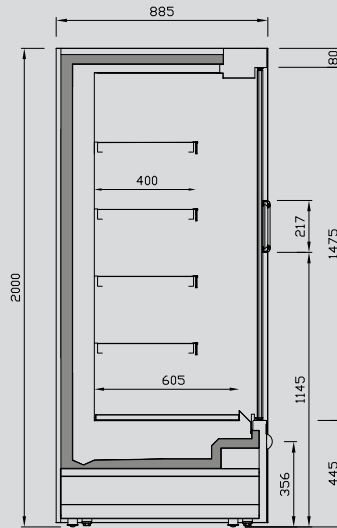

ML DCP M1/M2

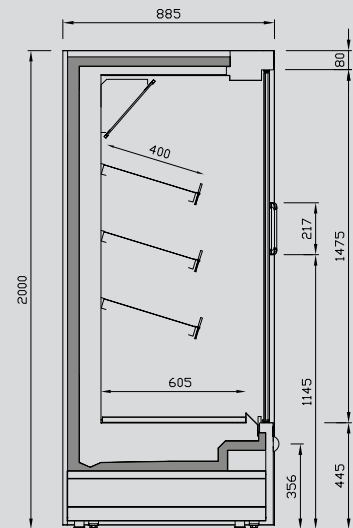

ML DCP H1









# Mural plug in de refrigeración abierta frente bajo

## Plug in refrigeration open low front multidecks

### Murale de réfrigération ouverte groupe incorporé avec frontal bas



MODELO MODELE MODÈLE					
<b>Precio</b> Price Prix	<b>M1 / C M1</b>				
<b>MOD.</b>	<b>MS6 P M2 / PC M2</b>	<b>MS9 P M2 / PC M2</b>	<b>MS12 P M2 / PC M2</b>	<b>MS18 P M2 / PC M2</b>	<b>MS25 P M2 / PC M2</b>
<b>Precio</b> Price Prix	<b>M2 / C M2</b>				
<b>MOD.</b>	<b>MS6 P H1 / PC H1</b>	<b>MS9 P H1 / PC H1</b>	<b>MS12 P H1 / PC H1</b>	<b>MS18 P H1 / PC H1</b>	<b>MS25 P H1 / PC H1</b>
<b>Precio</b> Price Prix	<b>H1 / C H1</b>				
<b>MOD.</b>	-	<b>MS9 PI M1 / PI M2</b>	<b>MS12 PI M1 / PI M2</b>	<b>MS18 PI M1 / PI M2</b>	-
<b>Precio</b> Price Prix	<b>INOX M1 / M2</b>				
<b>Medidas</b> Measures (mm) Mesures	625 x 685 x 2000 mm.	938 x 685 x 2000 mm.	1250 x 685 x 2000 mm.	1875 x 685 x 2000 mm.	2500 x 685 x 2000 mm.
<b>Tª. Prod.   Aplic.</b> Prod. Tª.   Applic. Tª. (°C) Temp. Prod.   Temp. Appliq.	<b>M1: -1/+5°C   0/+2°C    M2: -1/+7°C   +2/+4°C    H1: +1/+10°C   +4/+6°C</b>				
<b>Clase Climática</b> Climatic class (°C) Classe climatique	3 / 25°C				
<b>Tensión/Frecuencia</b> Electrical data Tension électrique	230V/1ph/50Hz				
<b>Controlador</b> Controller Régulateur	Digital				
<b>Material</b> Material [EXT/INT] Matériel	Acero galvanizado plastificado / Plastified galvanised steel / Acier galvanisé plastifié				
<b>Aislamiento</b> Isolation (mm) Isolation	40kg/m³ / Free CFC's / Zero ODP-GWP				
<b>Capacidad</b> Capacity (L) Capacité	M1, M2: 213 H1: 176	M1, M2: 320 H1: 264	M1, M2: 427 H1: 352	M1, M2: 640 H1: 527	M1, M2: 853 H1: 703
<b>Área refrigerada</b> Refrigerated area (x m²) Zone réfrigérée	M1, M2: 1,00 H1: 0,82	M1, M2: 1,51 H1: 1,22	M1, M2: 2,01 H1: 1,63	M1, M2: 3,01 H1: 2,45	M1, M2: 4,01 H1: 3,26
<b>Niveles Exposición</b> Exposition Levels Niveaux d'exposition	M1-M2: 4+Expos. H1: 3+Expos.				
<b>Costados [2]</b> Sides [2] (mm) Joues [2]	40 + 40				
<b>Puertas</b> Doors Portes	-	-	-	-	-
<b>Sistema de frío</b> Cooling System Système de froid	Ventilado / Ventilated / Ventilé				
<b>Desescarche</b> Defrost Dégivrage	Automático / Automatic / Automatique				
<b>Evaporación</b> Evaporation Evaporation	Forzada / Forced / Ventilé				
<b>Potencia</b> Power (W) Puissance	M1: 587    M2: - H1: 587	M1: 858    M2: 858 H1: 858	M1: 1250    M2: 1250 H1: 1250	M1: 2413    M2: 2413 H1: 2413	M1: 2374    M2: 2374 H1: 2374
<b>Potencia frig.</b> Cooling capacity (W A -10°C) Puissance Frig.	-				
<b>Consumo</b> Consumption (kWh/24h) Consommation	M1: 7,05    M2: 6,7 H1: 6,7	M1: 10,3    M2: 9,8 H1: 9,3	M1: 14,9    M2: 14,4 H1: 13,5	M1: 26,1    M2: 25,7 H1: 24,3	M1: 29,9    M2: 28,7 H1: 26,9
<b>Refrigerante</b> Refrigerant Gaz	<b>R-290</b>				
<b>Colores estándar</b> Standard colors Couleurs standard	<b>Ext. Estándar / Standar / Standard</b>		<b>Laterales / Sides / Joues</b>		
	Blanco/White/ Blanc	Ral 1015    Ral 1018	No incluidos / Not includes / Non inclus		
	Ral 2003	Ral 3003    Ral 3020			
<b>Laterales disponibles</b> Available sides Joues disponibles	Ral 5015	Ral 5017    Ral 5011	<b>Int. Estándar / Standar / Standard</b>		
	Ral 6002	Ral 6018    Ral 6019	Blanco/White/ Blanc		
	Ral 7035	Ral 7037    Ral 7042	Negro/Black/ Noir		
	Ral 7016	Ral 9006    Negro/Black/ Noir	Ral 7016		
<b>Opciones pág. 426-427</b> Options pages 426-427 Options pages 426-427			 Lateral Espejo Mirror end panels Joue Miroir  Lateral Display Display end panels Joue Display		



Serie / Series / Série **MP (MUNICH)**

+Info: [www.infrico.com](http://www.infrico.com)

MS18 P H1



**Nuevo  
paragolpes  
frontal**

**New  
front  
bumper**

**Nouveau  
pare-chocs  
frontale**



MS18 P M2

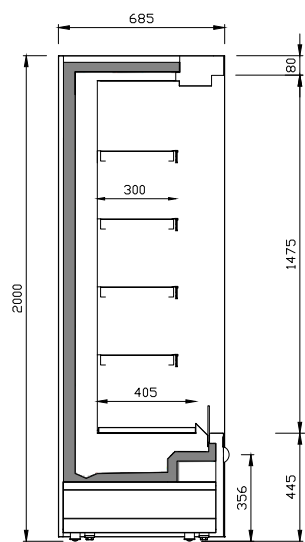

MS P M1/M2

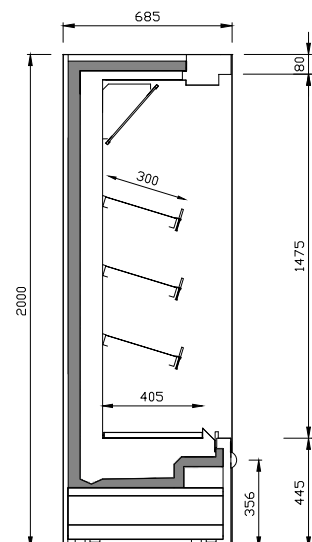

MS P H1









# Mural plug in de refrigeración abierta frente bajo

## Plug in refrigeration open low front multidecks

### Murale de réfrigération ouverte groupe incorporé avec frontal bas

**N: 785**

MODELO MODELE MODÈLE					
<b>Precio</b> Price Prix	<b>M1 / C M1</b>				
<b>MOD.</b>	<b>MN6 P M2 / PC M2</b>	<b>MN9 P M2 / PC M2</b>	<b>MN12 P M2 / PC M2</b>	<b>MN18 P M2 / PC M2</b>	<b>MN25 P M2 / PC M2</b>
<b>Precio</b> Price Prix	<b>M2 / C M2</b>				
<b>MOD.</b>	<b>MN6 P H1 / PC H1</b>	<b>MN9 P H1 / PC H1</b>	<b>MN12 P H1 / PC H1</b>	<b>MN18 P H1 / PC H1</b>	<b>MN25 P H1 / PC H1</b>
<b>Precio</b> Price Prix	<b>H1 / C H1</b>				
<b>MOD.</b>	-	<b>MN9 PI M1 / PI M2</b>	<b>MN12 PI M1 / PI M2</b>	<b>MN18 PI M1 / PI M2</b>	-
<b>Precio</b> Price Prix	<b>INOX M1 / M2</b>				
<b>Medidas</b> Measures Mesures (mm)	625 x 785 x 2000 mm.	938 x 785 x 2000 mm.	1250 x 785 x 2000 mm.	1875 x 785 x 2000 mm.	2500 x 785 x 2000 mm.
<b>Tª. Prod.   Aplic.</b> Prod. Tª.   Applic. Tª. (°C) Temp. Prod.   Temp. Appliq.	<b>M1: -1/+5°C   0/+2°C    M2: -1/+7°C   +2/+4°C    H1: +1/+10°C   +4/+6°C</b>				
<b>Clase Climática</b> Climatic class Classe climatique (°C)	3 / 25°C				
<b>Tensión/Frecuencia</b> Electrical data Tension électrique	230V/1ph/50Hz				
<b>Controlador</b> Controller Régulateur	Digital				
<b>Material</b> Material Matériel (EXT/INT)	Acero galvanizado plastificado / Plastified galvanised steel / Acier galvanisé plastifié				
<b>Aislamiento</b> Isolation Isolation (mm)	40kg/m³ / Free CFC's / Zero ODP-GWP				
<b>Capacidad</b> Capacity Capacité (L)	M1, M2: 279 H1: 229	M1, M2: 419 H1: 344	M1, M2: 558 H1: 458	M1, M2: 837 H1: 687	M1, M2: 1116 H1: 916
<b>Área refrigerada</b> Refrigerated area Zone réfrigérée (x m²)	M1, M2: 1,32 H1: 1,07	M1, M2: 1,97 H1: 1,60	M1, M2: 2,63 H1: 2,13	M1, M2: 3,95 H1: 3,20	M1, M2: 4,26 H1: 3,04
<b>Niveles Exposición</b> Exposition Levels Niveaux d'exposition	M1-M2: 4+Expos. H1: 3+Expos.				
<b>Costados [2]</b> Sides [2] Joues [2] (mm)	40 + 40				
<b>Puertas</b> Doors Portes	-	-	-	-	-
<b>Sistema de frío</b> Cooling System Système de froid	Ventilado / Ventilated / Ventilé				
<b>Desescarche</b> Defrost Dégivrage	Automático / Automatic / Automatique				
<b>Evaporación</b> Evaporation Evaporation	Forzada / Forced / Ventilé				
<b>Potencia</b> Power Puissance (W)	M1: -    M2: - H1: -	M1: 833    M2: 833 H1: 833	M1: 1225    M2: 1225 H1: 1225	M1: 2413    M2: 2413 H1: 2143	M1: 2449    M2: 2449 H1: 2449
<b>Potencia frig.</b> Cooling capacity Puissance Frig. (W A -10°C)	-				
<b>Consumo</b> Consumption Consommation (kWh/24h)	M1: -    M2: - H1: -	M1: 12.7    M2: 11.3 H1: 9.3	M1: 17.1    M2: 17.8 H1: 13.3	M1: 26.7    M2: 24.2 H1: 21.6	M1: 29.1    M2: 28.7 H1: 23.9
<b>Refrigerante</b> Refrigerant Gaz	<b>R-290</b>				
<b>Colores estándar</b> Standar colors Couleurs standard	<b>Ext. Estándar / Standar / Standard</b>		<b>Laterales / Sides / Joues</b>		
	Blanco/White/ Blanc	Ral 1015    Ral 1018	No Incluidos / Not includes / Non inclus		
	Ral 2003	Ral 3003    Ral 3020			
<b>Laterales disponibles</b> Available sides Joues disponibles	Ral 5015	Ral 5017    Ral 5011	<b>Int. Estándar / Standar / Standard</b>		
	Ral 6002	Ral 6018    Ral 6019	Blanco/White/ Blanc		
	Ral 7035	Ral 7037    Ral 7042	Negro/Black/ Noir		
	Ral 7016	Ral 9006    Negro/Black/ Noir	Ral 7016		
<b>Opciones pág. 426-427</b> Options pages 426-427 Options pages 426-427			 Lateral Espejo Mirror end panels Joue Miroir  Lateral Display Display end panels Joue Display		

10

Serie / Series / Série **MP (MUNICH)**

+Info: [www.infrico.com](http://www.infrico.com)

MN18 P M2



**Nuevo  
paragolpes  
frontal**

**New  
front  
bumper**

**Nouveau  
pare-chocs  
frontale**



MN18 P H1

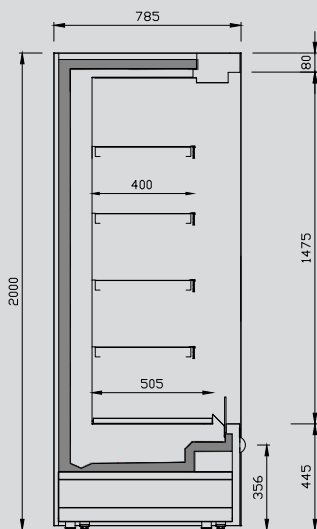

MN P M1/M2

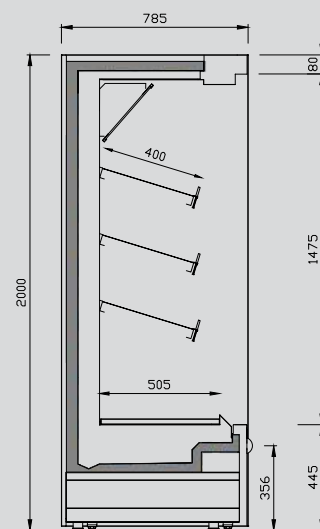

MN P H1





# Mural plug in de refrigeración abierta frente bajo

## Plug in refrigeration open low front multidecks

### Murale de réfrigération ouverte groupe incorporé avec frontal bas



MODELO MODELE MODÈLE	ML6 P M1 / PC M1	ML9 P M1 / PC M1	ML12 P M1 / PC M1	ML18 P M1 / PC M1	ML25 P M1 / PC M1
<b>Precio</b> Price Prix	<b>M1 / C M1</b>				
<b>MOD.</b>	<b>ML6 P M2 / PC M2</b>	<b>ML9 P M2 / PC M2</b>	<b>ML12 P M2 / PC M2</b>	<b>ML18 P M2 / PC M2</b>	<b>ML25 P M2 / PC M2</b>
<b>Precio</b> Price Prix	<b>M2 / C M2</b>				
<b>MOD.</b>	<b>ML6 P H1 / PC H1</b>	<b>ML9 P H1 / PC H1</b>	<b>ML12 P H1 / PC H1</b>	<b>ML18 P H1 / PC H1</b>	<b>ML25 P H1 / PC H1</b>
<b>Precio</b> Price Prix	<b>H1 / C H1</b>				
<b>MOD.</b>	-	<b>ML9 PI M1 / PI M2</b>	<b>ML12 PI M1 / PI M2</b>	<b>ML18 PI M1 / PI M2</b>	-
<b>Precio</b> Price Prix	<b>INOX M1 / M2</b>				
<b>Medidas</b> Measures Mesures (mm)	625 x 885 x 2000 mm.	938 x 885 x 2000 mm.	1250 x 885 x 2000 mm.	1875 x 885 x 2000 mm.	2500 x 885 x 2000 mm.
<b>Tª. Prod.   Aplic.</b> Prod. Tª.   Applic. Tª. (°C) Temp. Prod.   Temp. Appliq.	<b>M1: -1/+5°C   0/+2°C    M2: -1/+7°C   +2/+4°C    H1: +1/+10°C   +4/+6°C</b>				
<b>Clase Climática</b> Climatic class Classe climatique (°C)	3 / 25°C				
<b>Tensión/Frecuencia</b> Electrical data Tension électrique	230V/1ph/50Hz				
<b>Controlador</b> Controller Régulateur	Digital				
<b>Material</b> Material Matériel (EXT/INT)	Acero galvanizado plastificado / Plastified galvanised steel / Acier galvanisé plastifié				
<b>Aislamiento</b> Isolation Isolation (mm)	40kg/m³ / Free CFC's / Zero ODP-GWP				
<b>Capacidad</b> Capacity Capacité (L)	M1, M2: 295 H1: 245	M1, M2: 442 H1: 367	M1, M2: 589 H1: 489	M1, M2: 884 H1: 734	M1, M2: 1178 H1: 978
<b>Área refrigerada</b> Refrigerated area Zone réfrigérée (x m²)	M1, M2: 1,38 H1: 1,13	M1, M2: 2,07 H1: 1,69	M1, M2: 2,76 H1: 2,26	M1, M2: 4,13 H1: 3,38	M1, M2: 5,51 H1: 4,51
<b>Niveles Exposición</b> Exposition Levels Niveaux d'exposition	M1-M2: 4+Expos. H1: 3+Expos.				
<b>Costados [2]</b> Sides [2] Joues [2] (mm)	40 + 40				
<b>Puertas</b> Doors Portes	-	-	-	-	-
<b>Sistema de frío</b> Cooling System Système de froid	Ventilado / Ventilated / Ventilé				
<b>Desescarche</b> Defrost Dégivrage	Automático / Automatic / Automatique				
<b>Evaporación</b> Evaporation Évaporation	Forzada / Forced / Ventilé				
<b>Potencia</b> Power Puissance (W)	M1: -    M2: - H1: -	M1: 833    M2: 833 H1: 833	M1: 1225    M2: 1225 H1: 1225	M1: 2338    M2: 2338 H1: 2338	M1: 2374    M2: 2374 H1: 2374
<b>Potencia frig.</b> Cooling capacity Puissance Frig. (W A -10°C)	-				
<b>Consumo</b> Consumption Consommation (kWh/24h)	M1: -    M2: - H1: -	M1: 12.1    M2: 11.4 H1: 9.44	M1: 17.5    M2: 18.1 H1: 13.6	M1: 27.3    M2: 24.7 H1: 22.1	M1: 29.6    M2: 27.7 H1: 24.4
<b>Refrigerante</b> Refrigerant Gaz	<b>R-290</b>				
<b>Colores estándar</b> Standar colors Couleurs standard	<b>Ext. Estándar / Standar / Standard</b>		<b>Laterales / Sides / Joues</b>		
	Blanco/White/ Blanc	Ral 1015    Ral 1018	No Incluidos / Not includes / Non inclus		
	Ral 2003	Ral 3003    Ral 3020			
<b>Laterales disponibles</b> Available sides Joues disponibles	Ral 5015	Ral 5017    Ral 5011	<b>Int. Estándar / Standar / Standard</b>		
	Ral 6002	Ral 6018    Ral 6019	Blanco/White/ Blanc		
	Ral 7035	Ral 7037    Ral 7042	Negro/Black/ Noir		
	Ral 7016	Ral 9006    Negro/Black/ Noir	Ral 7016		
<b>Opciones pág. 426-427</b> Options pages 426-427 Options pages 426-427			 		





Serie / Series / Série **MP (MUNICH)**

+Info: [www.infrico.com](http://www.infrico.com)

ML18 P H1



**Nuevo  
paragolpes  
frontal**

**New  
front  
bumper**

**Nouveau  
pare-chocs  
frontale**



ML18 P M2

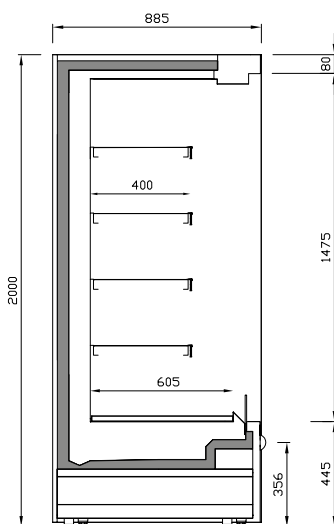

ML P M1/M2

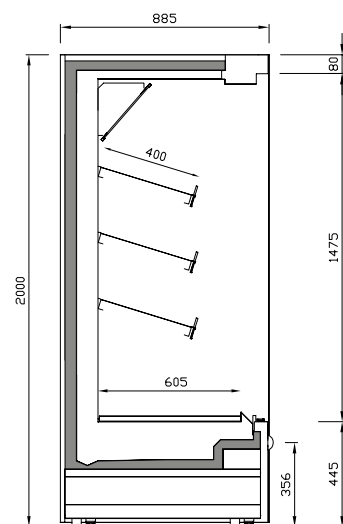

ML P H1











# Murales Experience para Quesos y Bacalao

Plug in R-290 Experience multidecks for cheese and codfish

Murale Experience de réfrigération groupe incorporé R-290 pour le fromage et la morue



MODELO MODELE MODÈLE	QUESOS / CHEESE / FROMAGE 	MS 12 BA M1 	BACALAO / CODFISH / MORUE 	MS 12 DC BA M1 
Precio Price Prix				
Medidas Measures [mm] Mesures	938 x 685 x 2000 mm.	1250 x 685 x 2000 mm.	938 x 685 x 2000 mm.	1250 x 685 x 2000 mm.
T°. Prod.   Aplic. Prod. T°.   Applic. T°. [°C] Temp. Prod.   Temp. Appliq.	<b>M1: -1/+5°C   0/+2°C</b>			
Clase Climática Climatic class Classe climatique [°C]	3 / 25°C			
Tensión/Frecuencia Electrical data Tension électrique	230V/1ph/50Hz			
Controlador Controller Régulateur	Digital			
Material Matériel [EXT/INT]	EXT: Acero inox AISI304 / Stainless Steel AISI304 / Acier inox AISI304 INT: Acero inox AISI304 (ventiladores, cubre evaporador, cuba) / Stainless Steel AISI304 (fans, cooler cover, tank) / Acier inox AISI304 (ventilateurs, couvercle évaporateur, bac) INT en contacto con producto / in contact with product / en contact avec le produit : Acero inox AISI316 / Stainless Steel AISI316 / Acier inox AISI316			
Aislamiento Isolation [mm]	40kg/m <sup>3</sup> / Free CFC's / Zero ODP-GWP			
Capacidad Capacity [L] Capacité	321	428	321	428
Superficie exposición Surface exhibition [x m <sup>2</sup> ] Surface d'exposition	1,51	2,01	1,51	2,01
Compresor Compressor [HP] Compresseur	3/4	3/4	1	1+1/4
Niveles Exposición Exposition Levels Niveaux d'exposition	-			
Costados [2] Sides [2] [mm] Joues [2]	40+40			
Sistema de frío Cooling System Système de froid	Ventilado / Ventilated / Ventilé			
Desescarche Defrost Dégivrage	Automático / Automatic / Automatique			
Evaporación Evaporation Évaporation	Forzada / Forced / Ventilé			
Potencia Power [W] Puissance	858	1250	602	715
Potencia frig. Cooling capacity [W A -10°C] Puissance Frig.	-			
Consumo Consumption [kWh/ 24h] Consommation	10,3	14,9	8,9	9,9
Refrigerante Refrigerant Gaz	<b>R-290</b>			
Colores estándar Standar colors Couleurs standard	Color exterior / Exterior color / Couleur extérieure 			
Laterales disponibles Available sides Joues disponibles	Color interior / Interior color / Couleur intérieure 			
Opciones pág. 426-427 Options pages 426-427 Options pages 426-427	  Lateral Espejo / Mirror end panels / Joue Miroir Lateral Display / Display end panels / Joue Display			



Serie / Series / Série **MSBA (OPORTO)**  
 Serie / Series / Série **MSDCBA (ORLEANS)**

+Info: [www.infrico.com](http://www.infrico.com)

MS 12 DC BA



MS 9 BA

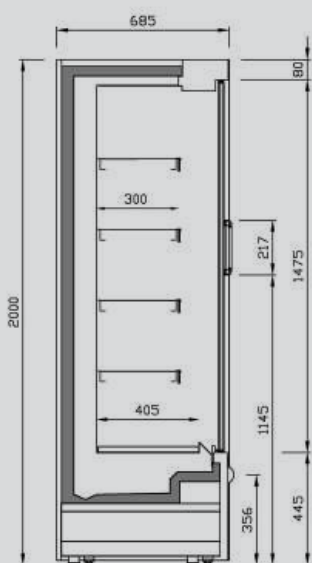

MS DC BA



**Nuevo paragolpes frontal**

**New front bumper**

**Nouveau pare-chocs frontale**

**Evaporador anticorrosión con tratamiento de cataforesis**

**Anti-corrosion evaporator with cataphoresis treatment**

**Evaporateur anti-corrosion avec traitement par cataphorèse**

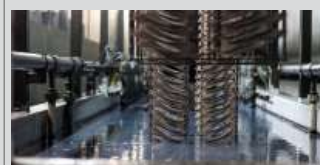

**Cataphoresis  
 Cataphoresis  
 Cataphorèse**

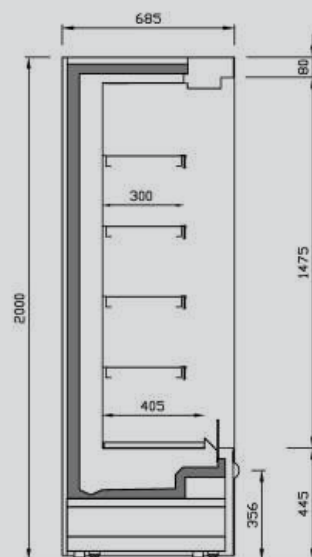

MS BA



# Mural remota de refrigeración cerrada frente medio

## Remote refrigeration doors middle front multideck

### Murale de réfrigération fermée groupe à distance front moyenne

N: 785

MODELO MODELE MODÈLE	MN12 DR M1	MN18 DR M1	MN25 DRM1	MN37 DR M1
Precio Price Prix	M1			
MOD.	MN12 DR M2	MN18 DR M2	MN25 DR M2	MN37 DR M2
Precio Price Prix	M2			
MOD.	MN12 DR H1	MN18 DR H1	MN25 DR H1	MN37 DR H1
Precio Price Prix	H1			
Medidas / Measures / Mesures / [mm]	1250 x 785 x 2050 mm.	1875 x 785 x 2050 mm.	2500 x 785 x 2050 mm.	3750 x 785 x 2050 mm.
Sin costados / Without sides / Sans joues				
T°. Prod.   Aplic. Prod. T°.   Applic. T°. [°C] Temp. Prod.   Temp. Appliq.	<b>M1: -1/+5°C   0/+2°C M2: -1/+7°C   +2/+4°C H1: +1/+10°C   +4/+6°C</b>			
Clase Climática Climatic class [°C] Classe climatique	3 / 25°C			
Tensión/Frecuencia Electrical data Tension électrique	230V/1ph/50Hz			
Controlador Controller Régulateur	Digital			
Material Material Matériel [EXT/INT]	Acero galvanizado plastificado / Plastified galvanised steel / Acier galvanisé plastifié			
Aislamiento Isolation Isolation [mm]	40kg/m <sup>3</sup> / Free CFC's / Zero ODP-GWP			
Capacidad Capacity Capacité [L]	M1, M2: 505 H1: 423	M1, M2: 758 H1: 634	M1, M2: 1010 H1: 845	M1, M2: 1515 H1: 1268
Superficie exposición Surface exhibition [x m <sup>2</sup> ] Surface d'exposition	1,65	2,47	3,30	5,04
Niveles Exposición Exposition Levels Niveaux d'exposition	M1, M2: 4+Expos. H1: 3+Expos.			
Costados [2] Sides [2] Joues [2] [mm]	40 + 40			
Puertas Doors Portes	2	3	4	6
Sistema de frío Cooling System Système de froid	Ventilado / Ventilated / Ventilé			
Desescarche Defrost Dégivrage	Automático / Automatic / Automatique			
Evaporación Evaporation Évaporation	Forzada / Forced / Ventilé			
Potencia Power Puissance [W]	-			
Potencia frig. Cooling capacity Puissance Frig. [W A -10°C]	M1: 850 M2: 734 H1: 606	M1: 1275 M2: 1101 H1: 908	M1: 1701 M2: 1468 H1: 1211	M1: 2551 M2: 2202 H1: 1817
Consumo Consumption Consommation [kWh/ 24h]	-			
Refrigerante Refrigerant Gaz	<b>FREON</b>			
Colores estándar Standard colors Couleurs standard	Int. Estándar / Standar / Standard			Laterales / Sides / Joues No Incluidos / Not includes / Non inclus 
	Blanco/White/ Blanc	Negro/Black/ Noir	Ral 7016	
	Ext. Estándar / Standar / Standard			
	Blanco/White/ Blanc	Ral 1015	Ral 1018	
	Ral 2003	Ral 3003	Ral 3020	
	Ral 5015	Ral 5017	Ral 5011	
	Ral 6002	Ral 6018	Ral 6019	
	Ral 7035	Ral 7037	Ral 7042	
	Ral 7016	Ral 9006	Negro/Black/ Noir	
	Laterales disponibles Available sides Joues disponibles			
Opciones pág. 426-427 Options pages 426-427 Options pages 426-427				

10

Serie / Series / Série **MDR (RIMINI)**

+Info: [www.infrico.com](http://www.infrico.com)

MN25DR M1



**Nuevo paragolpes frontal**

**New front bumper**

**Nouveau pare-chocs frontale**

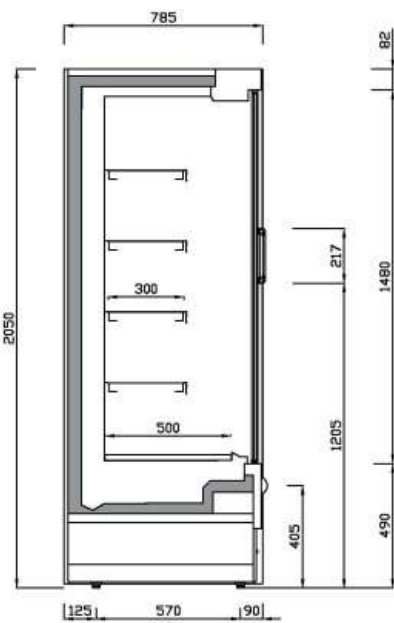

MN DR M1/M2

**Frente medio**  
**Middle front**  
**Front moyenne**

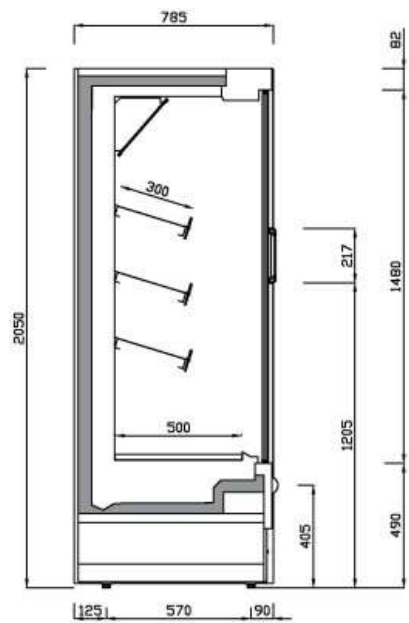

MN DR H1





# Mural remota de refrigeración cerrada frente medio

## Remote refrigeration doors middle front multideck

### Murale de réfrigération fermée groupe à distance front moyenne



MODELO MODELE MODÈLE	ML12 DR M1	ML18 DR M1	ML25 DRM1	ML31 DRM1	ML37 DR M1	
<b>Precio</b> Price Prix	<b>M1</b>					
<b>MOD.</b>	<b>ML12 DR M2</b>	<b>ML18 DR M2</b>	<b>ML25 DR M2</b>	<b>ML31 DR M2</b>	<b>ML37 DR M2</b>	
<b>Precio</b> Price Prix	<b>M2</b>					
<b>MOD.</b>	<b>ML12 DR H1</b>	<b>ML18 DR H1</b>	<b>ML25 DR H1</b>	<b>ML31 DR H1</b>	<b>ML37 DR H1</b>	
<b>Precio</b> Price Prix	<b>H1</b>					
<b>Medidas / Measures / Mesures / [mm]</b> <b>Sin costados / Without sides / Sans joues</b>	1250 x 885 x 2050 mm.	1875 x 885 x 2050 mm.	2500 x 885 x 2050 mm.	3125 x 885 x 2050 mm.	3750 x 885 x 2050 mm.	
<b>T°. Prod.   Aplic.</b> Prod. T°.   Applic. T°. [°C] Temp. Prod.   Temp. Appliq.	<b>M1: -1/+5°C   0/+2°C    M2: -1/+7°C   +2/+4°C    H1: +1/+10°C   +4/+6°C</b>					
<b>Clase Climática</b> Climatic class [°C] Classe climatique	3 / 25°C					
<b>Tensión/Frecuencia</b> Electrical data Tension électrique	230V/1ph/50Hz					
<b>Controlador</b> Controller Régulateur	Digital					
<b>Material</b> Material [EXT/INT] Matériel	Acero galvanizado plastificado / Plastified galvanised steel / Acier galvanisé plastifié					
<b>Aislamiento</b> Isolation [mm] Isolation	40kg/m <sup>3</sup> / Free CFC's / Zero ODP-GWP					
<b>Capacidad</b> Capacity [L] Capacité	M1, M2: 588 H1: 488	M1, M2: 881 H1: 731	M1, M2: 1175 H1: 975	M1, M2: 1469 H1: 1219	M1, M2: 1763 H1: 1460	
<b>Superficie exposición</b> Surface exhibition [x m <sup>2</sup> ] Surface d'exposition	M1, M2: 2,75 H1: 2,25	M1, M2: 4,13 H1: 3,40	M1, M2: 5,50 H1: 4,80	M1, M2: 6,80 H1: 5,60	M1, M2: 8,30 H1: 6,70	
<b>Niveles Exposición</b> Exposition Levels Niveaux d'exposition	M1, M2: 4+Expos. H1: 3+Expos.					
<b>Costados [2]</b> Sides [2] [mm] Joues [2]	40 + 40					
<b>Puertas</b> Doors Portes	2	3	4	5	6	
<b>Sistema de frío</b> Cooling System Système de froid	Ventilado / Ventilated / Ventilé					
<b>Desescarche</b> Defrost Dégivrage	Automático / Automatic / Automatique					
<b>Evaporación</b> Evaporation Évaporation	Forzada / Forced / Ventilé					
<b>Potencia</b> Power [W] Puissance	-					
<b>Potencia frig.</b> Cooling capacity [W A -10°C] Puissance Frig.	M1: 895    M2: 773 H1: 638	M1: 1343    M2: 1159 H1: 956	M1: 1790    M2: 1545 H1: 1275	M1: 2238    M2: 1931 H1: 1594	M1: 2685    M2: 2318 H1: 1913	
<b>Consumo</b> Consumption [kWh/24h] Consommation	-					
<b>Refrigerante</b> Refrigerant Gaz	<b>FREON</b>					
<b>Colores estándar</b> Standard colors Couleurs standard	<b>Int. Estándar / Standar / Standard</b>		<b>Laterales / Sides / Joues</b>			
	Blanco/White/ Blanc	Negro/Black/ Noir	Ral 7016	No Incluidos / Not includes / Non inclus		
<b>Laterales disponibles</b> Available sides Joues disponibles	<b>Ext. Estándar / Standar / Standard</b>					
	Blanco/White/ Blanc	Ral 1015	Ral 1018			
<b>Opciones pág. 426-427</b> Options pages 426-427 Options pages 426-427	Ral 2003	Ral 3003	Ral 3020			
	Ral 5015	Ral 5017	Ral 5011			
	Ral 6002	Ral 6018	Ral 6019			
	Ral 7035	Ral 7037	Ral 7042			
	Ral 7016	Ral 9006	Negro/Black/ Noir			
						
			Lateral Espejo Mirror end panels Joue Miroir	Lat. Panorámico Panoramic end panels Joue panoramique	Lateral Display Display end panels Joue Display	



Serie / Series / Série **MDR (RIMINI)**

+Info: [www.infrico.com](http://www.infrico.com)

ML37 DR M1

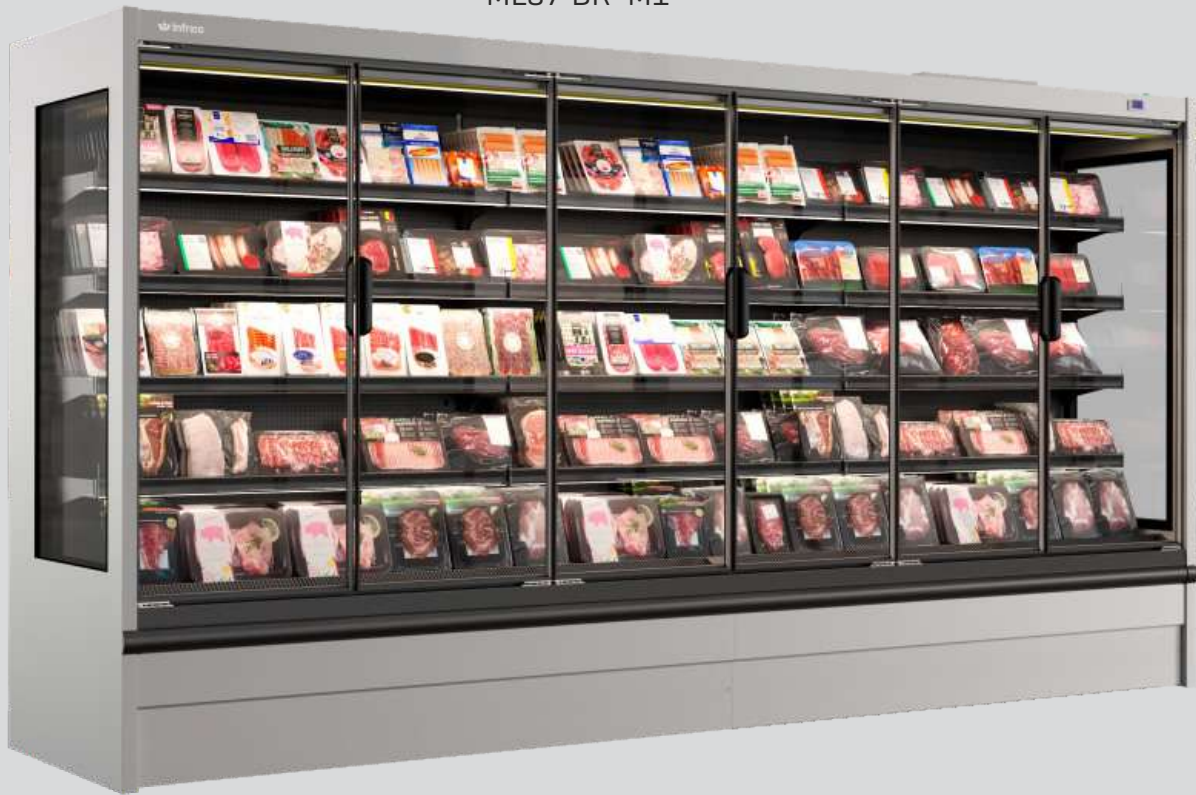

**Nuevo paragolpes frontal**

**New front bumper**

**Nouveau pare-chocs frontale**

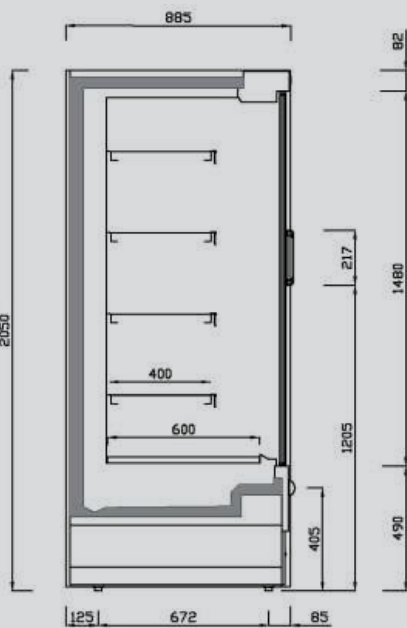

ML DR M1/M2

**Frente medio**  
**Middle front**  
**Front moyenne**

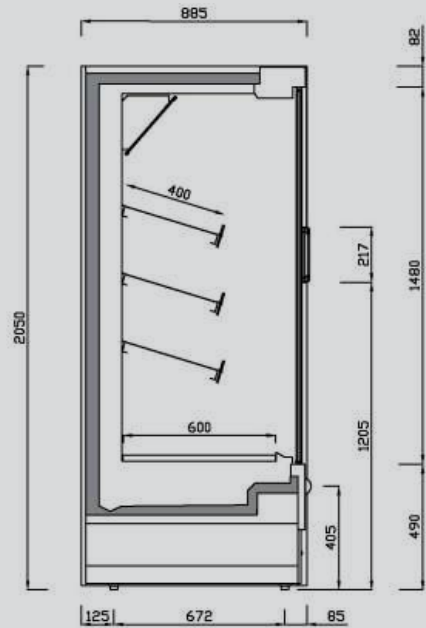

ML DR H1









# Mural remota de refrigeración cerradas

## Remote refrigeration doors multideck

### Murales de réfrigération fermée groupe à distance

S: 685

MODELO MODELE MODÈLE				
Precio Price Prix	<b>M1</b>			
MOD.	<b>MS12 DG M2</b>	<b>MS18 DG M2</b>	<b>MS25 DG M2</b>	<b>MS37 DG M2</b>
Precio Price Prix	<b>M2</b>			
MOD.	<b>MS12 DG H1</b>	<b>MS18 DG H1</b>	<b>MS25 DG H1</b>	<b>MS37 DG H1</b>
Precio Price Prix	<b>H1</b>			
Medidas / Measures / Mesuras / (mm)	1250 x 680 x 2050 mm.	1875 x 680 x 2050 mm.	2500 x 680 x 2050 mm.	3750 x 680 x 2050 mm.
Sin costados / Without sides / Sans joues				
T°. Prod.   Aplic. Prod. T°.   Applic. T°. (°C) Temp. Prod.   Temp. Appliq.	<b>M1: -1/+5°C   0/+2°C    M2: -1/+7°C   +2/+4°C    H1: +1/+10°C   +4/+6°C</b>			
Clase Climática Climatic class Classe climatique (°C)	3 / 25°C			
Tensión/Frecuencia Electrical data Tension électrique	230V/1ph/50Hz			
Controlador Controller Régulateur	Digital			
Material Material Matériel (EXT/INT)	Acero galvanizado plastificado / Plastified galvanised steel / Acier galvanisé plastifié			
Aislamiento Isolation Isolation (mm)	40kg/m <sup>3</sup> / Free CFC's / Zero ODP-GWP			
Capacidad Capacity Capacité (L)	M1, M2: 401 H1: 326	M1, M2: 602 H1: 489	M1, M2: 803 H1: 653	M1, M2: 1204 H1: 979
Superficie exposición Surface exhibition Surface d'exposition (x m <sup>2</sup> )	M1, M2: 2,01 H1: 1,63	M1, M2: 3,01 H1: 2,45	M1, M2: 4,01 H1: 3,26	M1, M2: 6,02 H1: 4,89
Niveles Exposición Exposition Levels Niveaux d'exposition	M1, M2: 4+Expos. H1: 3+Expos.			
Costados (2) Sides (2) Joues (2) (mm)	40 + 40			
Puertas Doors Portes	2	3	4	6
Sistema de frío Cooling System Système de froid	Ventilado / Ventilated / Ventilé			
Desescarche Defrost Dégivrage	Automático / Automatic / Automatique			
Evaporación Evaporation Évaporation	Forzada / Forced / Ventilé			
Potencia Power Puissance (W)	-			
Potencia frig. Cooling capacity Puissance Frig. (W A -10°C)	M1: 895    M2: 773 H1: 638	M1: 1343    M2: 1159 H1: 956	M1: 1790    M2: 1545 H1: 1275	M1: 2685    M2: 2318 H1: 1913
Consumo Consumption Consommation (kWh/ 24h)	-			
Refrigerante Refrigerant Gaz	<b>FREON</b>			
Colores estándar Standar colors Couleurs standard	Int. Estándar / Standar / Standard			Laterales / Sides / Joues <b>No Incluidos / Not includes / Non inclus</b>
	Blanco/White/ Blanc	Negro/Black/ Noir	Ral 7016	
Laterales disponibles Available sides Joues disponibles	Ext. Estándar / Standar / Standard			 Lateral Espejo Mirror end panels Joue Miroir  Lat. Panorámico Panoramic end panels Joue panoramique  Lateral Display Display end panels Joue Display
	Blanco/White/ Blanc	Ral 1015	Ral 1018	
Opciones pág. 426-427 Options pages 426-427 Options pages 426-427	Ral 2003	Ral 3003	Ral 3020	
	Ral 5015	Ral 5017	Ral 5011	
	Ral 6002	Ral 6018	Ral 6019	
	Ral 7035	Ral 7037	Ral 7042	
	Ral 7016	Ral 9006	Negro/Black/ Noir	

10



Serie / Series / Série **MDG (PORTLAND)**

+Info: [www.infrico.com](http://www.infrico.com)

MS37DG M2



MS25DG H1

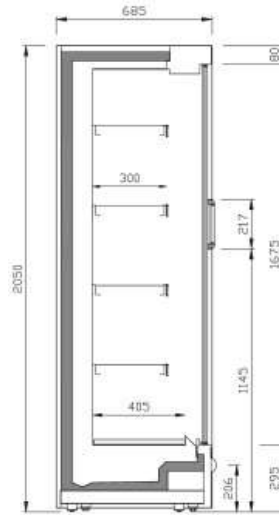

MS DG M1/M2

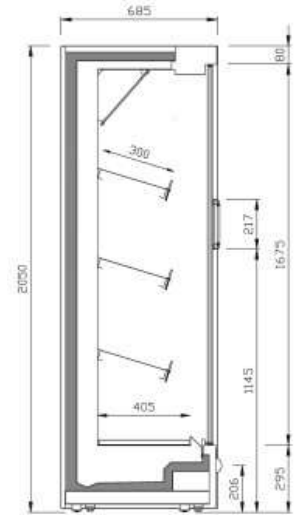

MS DG H1









# Mural remota de refrigeración cerradas

## Remote refrigeration doors multideck

### Murales de réfrigération fermée groupe à distance

**N: 785**

MODELO PRICE MODEL MODÈLE																									
<b>Precio</b> Price Prix	<b>M0</b>																								
<b>MOD.</b>	<b>MN12 DG M1</b>	<b>MN18 DG M1</b>	<b>MN25 DG M1</b>	<b>MN37 DG M1</b>																					
<b>Precio</b> Price Prix	<b>M1</b>																								
<b>MOD.</b>	<b>MN12 DG M2</b>	<b>MN18 DG M2</b>	<b>MN25 DG M2</b>	<b>MN37 DG M2</b>																					
<b>Precio</b> Price Prix	<b>M2</b>																								
<b>MOD.</b>	<b>MN12 DG H1</b>	<b>MN18 DG H1</b>	<b>MN25 DG H1</b>	<b>MN37 DG H1</b>																					
<b>Precio</b> Price Prix	<b>H1</b>																								
<b>Medidas / Measures / Mesures / [mm]</b> <b>Sin costados / Without sides / Sans joues</b>	1250 x 785 x 2050 mm.	1875 x 785 x 2050 mm.	2500 x 785 x 2050 mm.	3750 x 785 x 2050 mm.																					
<b>T°. Prod.   Aplic.</b> Prod. T°.   Applic. T°. (°C) Temp. Prod.   Temp. Appliq.	<b>M0: -1/+4°C   -1/+1°C    M1: -1/+5°C   0/+2°C    M2: -1/+7°C   +2/+4°C    H1: +1/+10°C   +4/+6°C</b>																								
<b>Clase Climática</b> Climatic class (°C) Classe climatique	3 / 25°C																								
<b>Tensión/Frecuencia</b> Electrical data Tension électrique	230V/1ph/50Hz																								
<b>Controlador</b> Controller Régulateur	Digital																								
<b>Material</b> Material (EXT/INT) Matériel	Acero galvanizado plastificado / Plastified galvanised steel / Acier galvanisé plastifié																								
<b>Aislamiento</b> Isolation (mm) Isolation	40kg/m <sup>3</sup> / Free CFC's / Zero ODP-GWP																								
<b>Capacidad</b> Capacity (L) Capacité	M0, M1, M2: 766 H1: 655	M0, M1, M2: 1149 H1: 983	M0, M1, M2: 1533 H1: 1310	M0, M1, M2: 2299 H1: 1965																					
<b>Superficie exposición</b> Surface exhibition (x m <sup>2</sup> ) Surface d'exposition	M0, M1, M2: 2,64 H1: 2,14	M0, M1, M2: 3,96 H1: 3,21	M0, M1, M2: 5,28 H1: 4,30	M0, M1, M2: 7,91 H1: 6,40																					
<b>Niveles Exposición</b> Exposition Levels Niveaux d'exposition	M0, M1, M2: 4+Expos. H1: 3+Expos.																								
<b>Costados (2)</b> Sides (2) (mm) Joues (2)	40 + 40																								
<b>Puertas</b> Doors Portes	2	3	4	6																					
<b>Sistema de frío</b> Cooling System Système de froid	Ventilado / Ventilated / Ventilé																								
<b>Desescarche</b> Defrost Dégivrage	Automático / Automatic / Automatique																								
<b>Evaporación</b> Evaporation Évaporation	Forzada / Forced / Ventilé																								
<b>Potencia</b> Power (W) Puissance	-																								
<b>Potencia frig.</b> Cooling capacity (W A -10°C) Puissance Frig.	M0: 986 M2: 773	M1: 895 H1: 638	M0: 1479 M2: 1159	M1: 1343 H1: 956																					
<b>Consumo</b> Consumption (kWh/24h) Consommation	-																								
<b>Refrigerante</b> Refrigerant Gaz	<b>FREON</b>																								
<b>Colores estándar</b> Standard colors Couleurs standard	<b>Ext. Estándar / Standar / Standard</b>		<b>Int. Estándar / Standar / Standard</b>																						
<b>Laterales disponibles</b> Available sides Joues disponibles	<table border="1"> <tr> <td>Blanco/White/Blanc</td> <td>Ral 1015</td> <td>Ral 1018</td> </tr> <tr> <td>Ral 2003</td> <td>Ral 3003</td> <td>Ral 3020</td> </tr> <tr> <td>Ral 5015</td> <td>Ral 5017</td> <td>Ral 5011</td> </tr> <tr> <td>Ral 6002</td> <td>Ral 6018</td> <td>Ral 6019</td> </tr> <tr> <td>Ral 7035</td> <td>Ral 7037</td> <td>Ral 7042</td> </tr> <tr> <td>Ral 7016</td> <td>Ral 9006</td> <td>Negro/Black/Noir</td> </tr> </table>		Blanco/White/Blanc	Ral 1015	Ral 1018	Ral 2003	Ral 3003	Ral 3020	Ral 5015	Ral 5017	Ral 5011	Ral 6002	Ral 6018	Ral 6019	Ral 7035	Ral 7037	Ral 7042	Ral 7016	Ral 9006	Negro/Black/Noir	<table border="1"> <tr> <td>Blanco/White/Blanc</td> <td>Negro/Black/Noir</td> <td>Ral 7016</td> </tr> </table>		Blanco/White/Blanc	Negro/Black/Noir	Ral 7016
Blanco/White/Blanc	Ral 1015	Ral 1018																							
Ral 2003	Ral 3003	Ral 3020																							
Ral 5015	Ral 5017	Ral 5011																							
Ral 6002	Ral 6018	Ral 6019																							
Ral 7035	Ral 7037	Ral 7042																							
Ral 7016	Ral 9006	Negro/Black/Noir																							
Blanco/White/Blanc	Negro/Black/Noir	Ral 7016																							
<b>Opciones pág. 426-427</b> Options pages 426-427 Options pages 426-427	<table border="1"> <tr> <td>Lat. Panorámico</td> <td>Lat. Espejo</td> <td>Lat. Display</td> </tr> <tr> <td>Panoramic end panels</td> <td>Mirror end panels</td> <td>Display end panels</td> </tr> <tr> <td>Joue panoramique</td> <td>Joue Miroir</td> <td>Joue Display</td> </tr> </table>		Lat. Panorámico	Lat. Espejo	Lat. Display	Panoramic end panels	Mirror end panels	Display end panels	Joue panoramique	Joue Miroir	Joue Display	  													
Lat. Panorámico	Lat. Espejo	Lat. Display																							
Panoramic end panels	Mirror end panels	Display end panels																							
Joue panoramique	Joue Miroir	Joue Display																							

10

Serie / Series / Série **MDG (PORTLAND)**

+Info: [www.infrico.com](http://www.infrico.com)

MN25DG M2



MN25DG H1

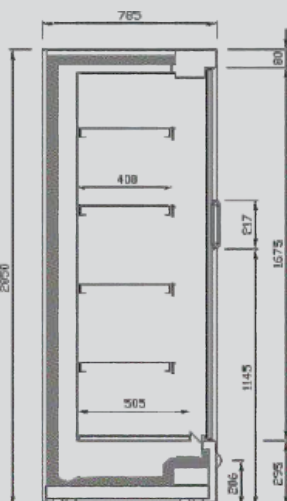

MN DG M0/M1/M2

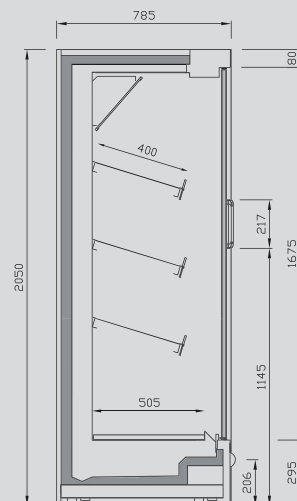

MN DG H1









# Mural remota de refrigeración cerradas

## Remote refrigeration doors multideck

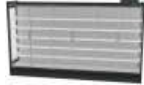
### Murales de réfrigération fermée groupe à distance

N: 785

MODELO PRICE MODEL MODÈLE																									
<b>Precio Price Prix</b> <b>MO</b>																									
<b>MOD.</b>	<b>MN12 DG22 M1</b>	<b>MN18 DG22 M1</b>	<b>MN25 DG22 M1</b>	<b>MN37 DG22 M1</b>																					
<b>Precio Price Prix</b> <b>M1</b>																									
<b>MOD.</b>	<b>MN12 DG22 M2</b>	<b>MN18 DG22 M2</b>	<b>MN25 DG22 M2</b>	<b>MN37 DG22 M2</b>																					
<b>Precio Price Prix</b> <b>M2</b>																									
<b>MOD.</b>	<b>MN12 DG22 H1</b>	<b>MN18 DG22 H1</b>	<b>MN25 DG22 H1</b>	<b>MN37 DG22 H1</b>																					
<b>Precio Price Prix</b> <b>H1</b>																									
<b>Medidas / Measures / Mesures / [mm]</b> <b>Sin costados / Without sides / Sans joues</b>	1250 x 785 x 2200 mm.	1875 x 785 x 2200 mm.	2500 x 785 x 2200 mm.	3750 x 785 x 2200 mm.																					
<b>T°. Prod.   Aplic. Prod. T°.   Applic. T°. (°C) Temp. Prod.   Temp. Appliq.</b>	<b>MO: -1/+4°C   -1/+1°C    M1: -1/+5°C   0/+2°C    M2: -1/+7°C   +2/+4°C    H1: +1/+10°C   +4/+6°C</b>																								
<b>Clase Climática Climatic class / Classe climatique (°C)</b>	3 / 25°C																								
<b>Tensión/Frecuencia Electrical data / Tension électrique</b>	230V/1ph/50Hz																								
<b>Controlador Controller / Régulateur</b>	Digital																								
<b>Material Material / Matériel (EXT/INT)</b>	Acero galvanizado plastificado / Plastified galvanised steel / Acier galvanisé plastifié																								
<b>Aislamiento Isolation / Isolation [mm]</b>	40kg/m <sup>3</sup> / Free CFC's / Zero ODP-GWP																								
<b>Capacidad Capacity / Capacité [L]</b>	MO, M1, M2: 816 H1: 705	MO, M1, M2: 1224 H1: 1058	MO, M1, M2: 1633 H1: 1410	MO, M1, M2: 2449 H1: 2115																					
<b>Superficie exposición Surface exhibition / Surface d'exposition [x m<sup>2</sup>]</b>	MO, M1, M2: 3,14 H1: 2,64	MO, M1, M2: 4,71 H1: 3,96	MO, M1, M2: 6,28 H1: 5,30	MO, M1, M2: 9,41 H1: 7,90																					
<b>Niveles Exposición Exposition Levels / Niveaux d'exposition</b>	MO, M1, M2: 5+Expos. H1: 4+Expos.																								
<b>Costados [2] Sides [2] / Jous [2] [mm]</b>	40 + 40																								
<b>Puertas Doors / Portes</b>	2	3	4	6																					
<b>Sistema de frío Cooling System / Système de froid</b>	Ventilado / Ventilated / Ventilé																								
<b>Desescarche Defrost / Dégivrage</b>	Automático / Automatic / Automatique																								
<b>Evaporación Evaporation / Évaporation</b>	Forzada / Forced / Ventilé																								
<b>Potencia Power / Puissance [W]</b>	-																								
<b>Potencia frig. Cooling capacity / Puissance Frig. [W A -10°C]</b>	MO: 1018    M1: 928 M2: 815    H1: 683	MO: 1596    M1: 1391 M2: 1223    H1: 1024	MO: 2035    M1: 1855 M2: 1630    H1: 1365	MO: 3053    M1: 2783 M2: 2445    H1: 2048																					
<b>Consumo Consumption / Consommation [kWh/24h]</b>	-																								
<b>Refrigerante Refrigerant / Gaz</b>	<b>FREON</b>																								
<b>Colores estándar Standard colors / Couleurs standard</b>	<b>Ext. Estándar / Standar / Standard</b>		<b>Int. Estándar / Standar / Standard</b>																						
<b>Laterales disponibles Available sides / Jous disponibles</b>	<table border="1"> <tr> <td>Blanco/White/Blanc</td> <td>Ral 1015</td> <td>Ral 1018</td> </tr> <tr> <td>Ral 2003</td> <td>Ral 3003</td> <td>Ral 3020</td> </tr> <tr> <td>Ral 5015</td> <td>Ral 5017</td> <td>Ral 5011</td> </tr> <tr> <td>Ral 6002</td> <td>Ral 6018</td> <td>Ral 6019</td> </tr> <tr> <td>Ral 7035</td> <td>Ral 7037</td> <td>Ral 7042</td> </tr> <tr> <td>Ral 7016</td> <td>Ral 9006</td> <td>Negro/Black/Noir</td> </tr> </table>		Blanco/White/Blanc	Ral 1015	Ral 1018	Ral 2003	Ral 3003	Ral 3020	Ral 5015	Ral 5017	Ral 5011	Ral 6002	Ral 6018	Ral 6019	Ral 7035	Ral 7037	Ral 7042	Ral 7016	Ral 9006	Negro/Black/Noir	<table border="1"> <tr> <td>Blanco/White/Blanc</td> <td>Negro/Black/Noir</td> <td>Ral 7016</td> </tr> </table>		Blanco/White/Blanc	Negro/Black/Noir	Ral 7016
Blanco/White/Blanc	Ral 1015	Ral 1018																							
Ral 2003	Ral 3003	Ral 3020																							
Ral 5015	Ral 5017	Ral 5011																							
Ral 6002	Ral 6018	Ral 6019																							
Ral 7035	Ral 7037	Ral 7042																							
Ral 7016	Ral 9006	Negro/Black/Noir																							
Blanco/White/Blanc	Negro/Black/Noir	Ral 7016																							
<b>Opciones pág. 426-427 Options pages 426-427</b>	<table border="1"> <tr> <td>No Incluidos / Not includes / Non inclus</td> </tr> </table>		No Incluidos / Not includes / Non inclus	  																					
No Incluidos / Not includes / Non inclus																									
			<p>Lateral Espejo Mirror end panels Joue Miroir</p> <p>Lat. Panorámico Panoramic end panels Joue panoramique</p> <p>Lateral Display Display end panels Joue Display</p>																						

10

Serie / Series / Série **MDG (PORTLAND)**

+Info: [www.infrico.com](http://www.infrico.com)

MN37DG22 M2



**Nuevo  
paragolpes  
frontal**

**New  
front  
bumper**

**Nouveau  
pare-chocs  
frontale**



MN25DG22 H1

**Lateral panorámico**  
Panoramic side panel  
Joue panoramique

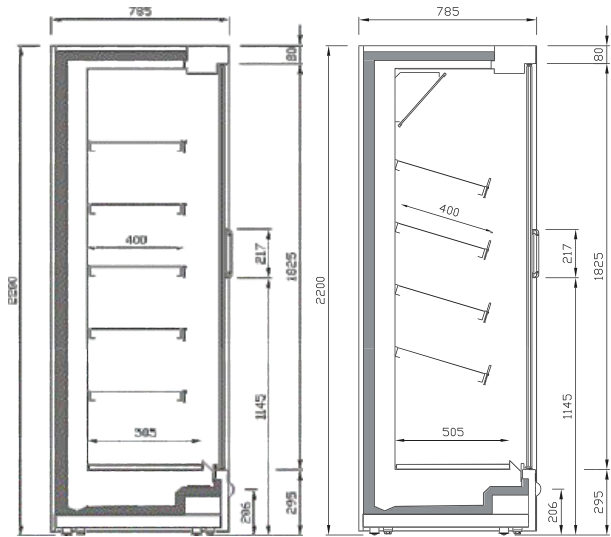

MN DG22 M0/M1/M2

MN DG22 H1



# Mural remota de refrigeración cerradas

## Remote refrigeration doors multideck

### Murales de réfrigération fermée groupe à distance



MODELO MODELE MODÈLE										
Precio Price Prix	<b>M0</b>									
MOD.	<b>ML12 DG M1</b>	<b>ML18 DG M1</b>	<b>ML25 DG M1</b>	<b>ML31 DG M1</b>	<b>ML37 DG M1</b>					
Precio Price Prix	<b>M1</b>									
MOD.	<b>ML12 DG M2</b>	<b>ML18 DG M2</b>	<b>ML25 DG M2</b>	<b>ML31 DG M2</b>	<b>ML37 DG M2</b>					
Precio Price Prix	<b>M2</b>									
MOD.	<b>ML12 DG H1</b>	<b>ML18 DG H1</b>	<b>ML25 DG H1</b>	<b>ML31 DG H1</b>	<b>ML37 DG H1</b>					
Precio Price Prix	<b>H1</b>									
Medidas / Measures / Mesures / [mm]	1250 x 885	1875 x 885	2500 x 885	3125 x 885	3750 x 885					
Sin costados / Without sides / Sans joues	x 2050 mm.									
T°. Prod.   Aplic. Prod. T°.   Applic. T°. [°C] Temp. Prod.   Temp. Appliq.	<b>M0: -1/+4°C   -1/+1°C    M1: -1/+5°C   0/+2°C    M2: -1/+7°C   +2/+4°C    H1: +1/+10°C   +4/+6°C</b>									
Clase Climática Climatic class [°C] Classe climatique	3 / 25°C									
Tensión/Frecuencia Electrical data Tension électrique	230V/1ph/50Hz									
Controlador Controller Régulateur	Digital									
Material Material Matériel [EXT/INT]	Acero galvanizado plastificado / Plastified galvanised steel / Acier galvanisé plastifié									
Aislamiento Isolation Isolation [mm]	40kg/m <sup>3</sup> / Free CFC's / Zero ODP-GWP									
Capacidad Capacity Capacité [L]	803	1204	1605	2006	2408					
Superficie exposición Surface exhibition [x m <sup>2</sup> ] Surface d'exposition	2,76	4,13	5,51	6,80	8,30					
Niveles Exposición Exposition Levels Niveaux d'exposition	M0, M1, M2: 4+Expos. H1: 3+Expos.									
Costados [2] Sides [2] Joues [2] [mm]	40 + 40									
Puertas Doors Portes	2	3	4	5	6					
Sistema de frío Cooling System Système de froid	Ventilado / Ventilated / Ventilé									
Desescarche Defrost Dégivrage	Automático / Automatic / Automatique									
Evaporación Evaporation Évaporation	Forzada / Forced / Ventilé									
Potencia Power Puissance [W]	-									
Potencia frig. Cooling capacity Puissance Frig. [W A -10°C]	M0: 986 M2: 773	M1: 895 H1: 638	M0: 1479 M2: 1159	M1: 1343 H1: 956	M0: 1973 M2: 1545	M1: 1790 H1: 1275	M0: 2466 M2: 1931	M1: 2238 H1: 1594	M0: 2959 M2: 2318	M1: 2685 H1: 1913
Consumo Consumption Consommation [kWh/ 24h]	-									
Refrigerante Refrigerant Gaz	<b>FREON</b>									
Colores estándar Standard colors Couleurs standard	<b>Ext. Estándar / Standar / Standard</b>		<b>Int. Estándar / Standar / Standard</b>			<p>Lateral Espejo Mirror end panels Joue Miroir</p> <p>Lat. Panorámico Panoramic end panels Joue panoramique</p> <p>Lateral Display Display end panels Joue Display</p>				
Laterales disponibles Available sides Joues disponibles	Blanco/White/ Blanc	Ral 1015	Ral 1018	Blanco/White/ Blanc	Negro/Black/ Noir		Ral 7016			
	Ral 2003	Ral 3003	Ral 3020							
	Ral 5015	Ral 5017	Ral 5011							
	Ral 6002	Ral 6018	Ral 6019							
	Ral 7035	Ral 7037	Ral 7042							
	Ral 7016	Ral 9006	Negro/Black/ Noir							
Opciones pág. 426-427 Options pages 426-427 Options pages 426-427	No Incluidos / Not includes / Non inclus									

Serie / Series / Série **MDG (PORTLAND)**

+Info: [www.infrico.com](http://www.infrico.com)

ML25DG H1



**Nuevo  
paragolpes  
frontal**

**New  
front  
bumper**

**Nouveau  
pare-chocs  
frontale**



ML25DG M2

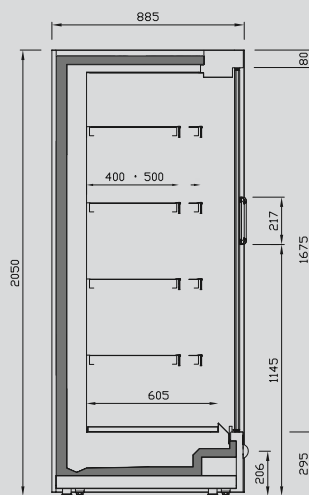

ML DG M0/M1/M2

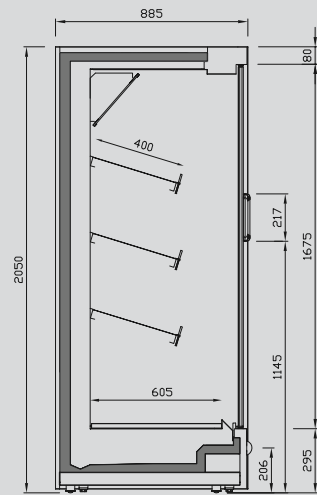

ML DG H1











# Mural remota de refrigeración cerradas

## Remote refrigeration doors multideck

### Murales de réfrigération fermée groupe à distance



MODELO MODELE MODÈLE																										
<b>Precio</b> Price Prix	<b>M0</b>																									
<b>MOD.</b>	<b>ML12 DG22 M1</b>	<b>ML18 DG22 M1</b>	<b>ML25 DG22 M1</b>	<b>ML31 DG22 M1</b>	<b>ML37 DG22 M1</b>																					
<b>Precio</b> Price Prix	<b>M1</b>																									
<b>MOD.</b>	<b>ML12 DG22 M2</b>	<b>ML18 DG22 M2</b>	<b>ML25 DG22 M2</b>	<b>ML31 DG22 M2</b>	<b>ML37 DG22 M2</b>																					
<b>Precio</b> Price Prix	<b>M2</b>																									
<b>MOD.</b>	<b>ML12 DG22 H1</b>	<b>ML18 DG22 H1</b>	<b>ML25 DG22 H1</b>	<b>ML31 DG22 H1</b>	<b>ML37 DG22 H1</b>																					
<b>Precio</b> Price Prix	<b>H1</b>																									
<b>Medidas / Measures /</b> Mesures / [mm] <b>Sin costados / Without</b> sides / Sans joues	1250 x 885 x 2200 mm.	1875 x 885 x 2200 mm.	2500 x 885 x 2200 mm.	3125 x 885 x 2200 mm.	3750 x 885 x 2200 mm.																					
<b>T°. Prod.   Aplic.</b> Prod. T°.   Applic. T°. (°C) Temp. Prod.   Temp. Appliq.	<b>M0: -1/+4°C   -1/+1°C</b> <b>M1: -1/+5°C   0/+2°C</b> <b>M2: -1/+7°C   +2/+4°C</b> <b>H1: +1/+10°C   +4/+6°C</b>																									
<b>Clase Climática</b> Climatic class Classe climatique (°C)	3 / 25°C																									
<b>Tensión/Frecuencia</b> Electrical data Tension électrique	230V/1ph/50Hz																									
<b>Controlador</b> Controller Régulateur	Digital																									
<b>Material</b> Material Matériel (EXT/INT)	Acero galvanizado plastificado / Plastified galvanised steel / Acier galvanisé plastifié																									
<b>Aislamiento</b> Isolation Isolation [mm]	40kg/m <sup>3</sup> / Free CFC's / Zero ODP-GWP																									
<b>Capacidad</b> Capacity Capacité [L]	849	1273	1698	2122	2546																					
<b>Superficie exposición</b> Surface exhibition [x m <sup>2</sup> ] Surface d'exposition	3,26	4,88	6,51	8,14	9,7																					
<b>Niveles Exposición</b> Exposition Levels Niveaux d'exposition	M0, M1, M2: 5+Expos. H1: 4+Expos.																									
<b>Costados [2]</b> Sides [2] Joues [2] [mm]	40 + 40																									
<b>Puertas</b> Doors Portes	2	3	4	5	6																					
<b>Sistema de frío</b> Cooling System Système de froid	Ventilado / Ventilated / Ventilé																									
<b>Desescarche</b> Defrost Dégivrage	Automático / Automatic / Automatique																									
<b>Evaporación</b> Evaporation Évaporation	Forzada / Forced / Ventilé																									
<b>Potencia</b> Power Puissance [W]	-																									
<b>Potencia frig.</b> Cooling capacity Puissance Frig. [W A -10°C]	M0: 1018 M2: 815	M1: 928 H1: 683	M0: 1596 M2: 1223	M1: 1391 H1: 1024	M0: 2035 M2: 1630	M1: 1855 H1: 1365	M0: 2544 M2: 2041	M1: 2319 H1: 1706	M0: 3053 M2: 2445	M1: 2783 H1: 2048																
<b>Consumo</b> Consumption Consommation [kWh/ 24h]	-																									
<b>Refrigerante</b> Refrigerant Gaz	<b>FREON</b>																									
<b>Colores estándar</b> Standard colors Couleurs standard	<b>Ext. Estándar / Standar / Standard</b>			<b>Int. Estándar / Standar / Standard</b>																						
<b>Laterales disponibles</b> Available sides Joues disponibles	<table border="1"> <tr> <td>Blanco/White/ Blanc</td> <td>Ral 1015</td> <td>Ral 1018</td> </tr> <tr> <td>Ral 2003</td> <td>Ral 3003</td> <td>Ral 3020</td> </tr> <tr> <td>Ral 5015</td> <td>Ral 5017</td> <td>Ral 5011</td> </tr> <tr> <td>Ral 6002</td> <td>Ral 6018</td> <td>Ral 6019</td> </tr> <tr> <td>Ral 7035</td> <td>Ral 7037</td> <td>Ral 7042</td> </tr> <tr> <td>Ral 7016</td> <td>Ral 9006</td> <td>Negro/Black/ Noir</td> </tr> </table>			Blanco/White/ Blanc	Ral 1015	Ral 1018	Ral 2003	Ral 3003	Ral 3020	Ral 5015	Ral 5017	Ral 5011	Ral 6002	Ral 6018	Ral 6019	Ral 7035	Ral 7037	Ral 7042	Ral 7016	Ral 9006	Negro/Black/ Noir	<table border="1"> <tr> <td>Blanco/White/ Blanc</td> <td>Negro/Black/ Noir</td> <td>Ral 7016</td> </tr> </table>		Blanco/White/ Blanc	Negro/Black/ Noir	Ral 7016
Blanco/White/ Blanc	Ral 1015	Ral 1018																								
Ral 2003	Ral 3003	Ral 3020																								
Ral 5015	Ral 5017	Ral 5011																								
Ral 6002	Ral 6018	Ral 6019																								
Ral 7035	Ral 7037	Ral 7042																								
Ral 7016	Ral 9006	Negro/Black/ Noir																								
Blanco/White/ Blanc	Negro/Black/ Noir	Ral 7016																								
<b>Opciones pág. 426-427</b> Options pages 426-427 Options pages 426-427	<p><b>No Incluidos / Not includes / Non inlues</b></p>			  																						
				<p>Lateral Espejo Mirror end panels Joue Miroir</p> <p>Lat. Panorámico Panoramic end panels Joue panoramique</p> <p>Lateral Display Display end panels Joue Display</p>																						

10



Serie / Series / Série **MDG (PORTLAND)**

+Info: [www.infrico.com](http://www.infrico.com)

ML37DG22 M2



ML37DG22 M2

**Lateral panorámico**  
Panoramic side panel  
Joue panoramique

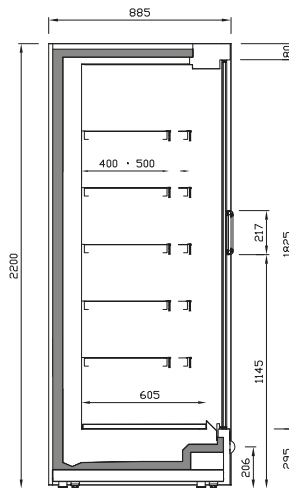

ML DG22 MO/M1/M2

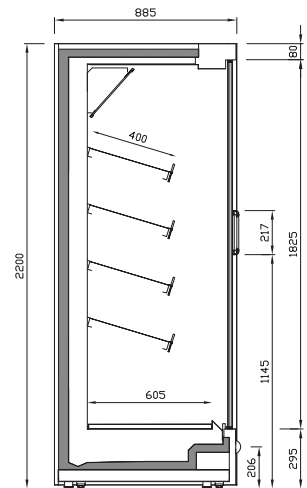

ML DG22 H1









# Mural remota de refrigeración cerradas

## Remote refrigeration doors multideck

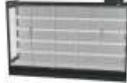
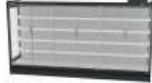
### Murales de réfrigération fermée groupe à distance



MODELO MODELE MODÈLE																										
<b>Precio</b> Price Prix	<b>M0</b>																									
<b>MOD.</b>	<b>MX12 DG M1</b>	<b>MX18 DG M1</b>	<b>MX25 DG M1</b>	<b>MX31 DG M1</b>	<b>MX37 DG M1</b>																					
<b>Precio</b> Price Prix	<b>M1</b>																									
<b>MOD.</b>	<b>MX12 DG M2</b>	<b>MX18 DG M2</b>	<b>MX25 DG M2</b>	<b>MX31 DG M2</b>	<b>MX37 DG M2</b>																					
<b>Precio</b> Price Prix	<b>M2</b>																									
<b>MOD.</b>	<b>MX12 DG H1</b>	<b>MX18 DG H1</b>	<b>MX25 DG H1</b>	<b>MX31 DG H1</b>	<b>MX37 DG H1</b>																					
<b>Precio</b> Price Prix	<b>H1</b>																									
<b>Medidas / Measures /</b> Mesures / [mm] <b>Sin costados / Without</b> sides / Sans joues	1250 x 1085 x 2050 mm.	1875 x 1085 x 2050 mm.	2500 x 1085 x 2050 mm.	3125 x 1085 x 2050 mm.	3750 x 1085 x 2050 mm.																					
<b>T°. Prod.   Aplic.</b> Prod. T°.   Applic. T°. (°C) Temp. Prod.   Temp. Appliq.	<b>M0: -1/+4°C   -1/+1°C    M1: -1/+5°C   0/+2°C    M2: -1/+7°C   +2/+4°C    H1: +1/+10°C   +4/+6°C</b>																									
<b>Clase Climática</b> Climatic class (°C) Classe climatique	3 / 25°C																									
<b>Tensión/Frecuencia</b> Electrical data Tension électrique	230V/1ph/50Hz																									
<b>Controlador</b> Controller Régulateur	Digital																									
<b>Material</b> Material (EXT/INT) Matériel	Acero galvanizado plastificado / Plastified galvanised steel / Acier galvanisé plastifié																									
<b>Aislamiento</b> Isolation [mm] Isolation	40kg/m <sup>3</sup> / Free CFC's / Zero ODP-GWP																									
<b>Capacidad</b> Capacity [L] Capacité	M0, M1, M2: 1166 H1: 985	M0, M1, M2: 1749 H1: 1478	M0, M1, M2: 2333 H1: 1970	M0, M1, M2: 2916 H1: 2463	M0, M1, M2: 3499 H1: 2955																					
<b>Superficie exposición</b> Surface exhibition [x m <sup>2</sup> ] Surface d'exposition	M0, M1, M2: 4,01 H1: 3,26	M0, M1, M2: 6,02 H1: 4,90	M0, M1, M2: 8,10 H1: 6,50	M0, M1, M2: 10,1 H1: 8,10	M0, M1, M2: 12,0 H1: 9,80																					
<b>Niveles Exposición</b> Exposition Levels Niveaux d'exposition	M0, M1, M2: 4+Expos. H1: 3+Expos.																									
<b>Costados [2]</b> Sides [2] [mm] Joues [2]	40 + 40																									
<b>Puertas</b> Doors Portes	2	3	4	5	6																					
<b>Sistema de frío</b> Cooling System Système de froid	Ventilado / Ventilated / Ventilé																									
<b>Desescarche</b> Defrost Dégivrage	Automático / Automatic / Automatique																									
<b>Evaporación</b> Evaporation Évaporation	Forzada / Forced / Ventilé																									
<b>Potencia</b> Power [W] Puissance	-																									
<b>Potencia frig.</b> Cooling capacity [W A -10°C] Puissance Frig.	M0: 986 M2: 773	M1: 895 H1: 638	M0: 1479 M2: 1159	M1: 1343 H1: 956	M0: 1973 M2: 1545	M1: 1790 H1: 1275	M0: 2466 M2: 1931	M1: 2238 H1: 1594	M0: 2959 M2: 2318	M1: 2685 H1: 1913																
<b>Consumo</b> Consumption [kWh/ 24h] Consommation	-																									
<b>Refrigerante</b> Refrigerant Gaz	<b>FREON</b>																									
<b>Colores estándar</b> Standard colors Couleurs standard	<b>Ext. Estándar / Standar / Standard</b>			<b>Int. Estándar / Standar / Standard</b>																						
<b>Laterales disponibles</b> Available sides Joues disponibles	<table border="1"> <tr> <td>Blanco/White/ Blanc</td> <td>Ral 1015</td> <td>Ral 1018</td> </tr> <tr> <td>Ral 2003</td> <td>Ral 3003</td> <td>Ral 3020</td> </tr> <tr> <td>Ral 5015</td> <td>Ral 5017</td> <td>Ral 5011</td> </tr> <tr> <td>Ral 6002</td> <td>Ral 6018</td> <td>Ral 6019</td> </tr> <tr> <td>Ral 7035</td> <td>Ral 7037</td> <td>Ral 7042</td> </tr> <tr> <td>Ral 7016</td> <td>Ral 9006</td> <td>Negro/Black/ Noir</td> </tr> </table>			Blanco/White/ Blanc	Ral 1015	Ral 1018	Ral 2003	Ral 3003	Ral 3020	Ral 5015	Ral 5017	Ral 5011	Ral 6002	Ral 6018	Ral 6019	Ral 7035	Ral 7037	Ral 7042	Ral 7016	Ral 9006	Negro/Black/ Noir	<table border="1"> <tr> <td>Blanco/White/ Blanc</td> <td>Negro/Black/ Noir</td> <td>Ral 7016</td> </tr> </table>		Blanco/White/ Blanc	Negro/Black/ Noir	Ral 7016
Blanco/White/ Blanc	Ral 1015	Ral 1018																								
Ral 2003	Ral 3003	Ral 3020																								
Ral 5015	Ral 5017	Ral 5011																								
Ral 6002	Ral 6018	Ral 6019																								
Ral 7035	Ral 7037	Ral 7042																								
Ral 7016	Ral 9006	Negro/Black/ Noir																								
Blanco/White/ Blanc	Negro/Black/ Noir	Ral 7016																								
<b>Opciones pág. 426-427</b> Options pages 426-427 Options pages 426-427	<table border="1"> <tr> <td colspan="3"><b>No Incluidos / Not includes / Non inclus</b></td> </tr> </table>			<b>No Incluidos / Not includes / Non inclus</b>			  																			
<b>No Incluidos / Not includes / Non inclus</b>																										
				<p>Lateral Espejo Mirror end panels Joue Miroir</p> <p>Lat. Panorámico Panoramic end panels Joue panoramique</p> <p>Lateral Display Display end panels Joue Display</p>																						

10

Serie / Series / Série **MDG (PORTLAND)**

+Info: [www.infrico.com](http://www.infrico.com)

MX25DG H1



MX37DG M2

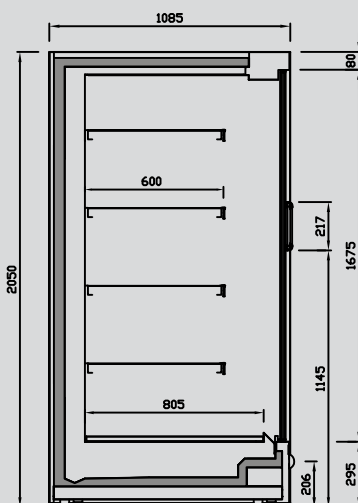

MX DG M0/M1/M2

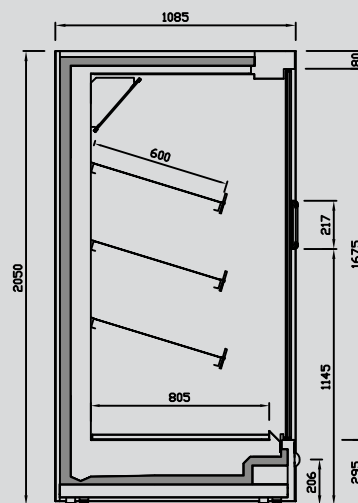

MX DG H1











# Mural remota de refrigeración cerradas

## Remote refrigeration doors multideck

### Murales de réfrigération fermée groupe à distance



MODELO MODELE MODÈLE										
<b>Precio</b> Price Prix	<b>M0</b>									
<b>MOD.</b>	<b>MX12 DG22 M1</b>	<b>MX18 DG22 M1</b>	<b>MX25 DG22 M1</b>	<b>MX31 DG22 M1</b>	<b>MX37 DG22 M1</b>					
<b>Precio</b> Price Prix	<b>M1</b>									
<b>MOD.</b>	<b>MX12 DG22 M2</b>	<b>MX18 DG22 M2</b>	<b>MX25 DG22 M2</b>	<b>MX31 DG22 M2</b>	<b>MX37 DG22 M2</b>					
<b>Precio</b> Price Prix	<b>M2</b>									
<b>MOD.</b>	<b>MX12 DG22 H1</b>	<b>MX18 DG22 H1</b>	<b>MX25 DG22 H1</b>	<b>MX31 DG22 H1</b>	<b>MX37 DG22 H1</b>					
<b>Precio</b> Price Prix	<b>H1</b>									
<b>Medidas / Measures /</b> Mesures / [mm] <b>Sin costados / Without</b> sides / Sans joues	1250 x 1085 x 2200 mm.	1875 x 1085 x 2200 mm.	2500 x 1085 x 2200 mm.	3125 x 1085 x 2200 mm.	3750 x 1085 x 2200 mm.					
<b>T°. Prod.   Aplic.</b> Prod. T°.   Applic. T°. (°C) Temp. Prod.   Temp. Appliq.	<b>M0: -1/+4°C   -1/+1°C</b> <b>M1: -1/+5°C   0/+2°C</b> <b>M2: -1/+7°C   +2/+4°C</b> <b>H1: +1/+10°C   +4/+6°C</b>									
<b>Clase Climática</b> Climatic class (°C) Classe climatique	3 / 25°C									
<b>Tensión/Frecuencia</b> Electrical data Tension électrique	230V/1ph/50Hz									
<b>Controlador</b> Controller Régulateur	Digital									
<b>Material</b> Material (EXT/INT) Matériel	Acero galvanizado plastificado / Plastified galvanised steel / Acier galvanisé plastifié									
<b>Aislamiento</b> Isolation [mm] Isolation	40kg/m <sup>3</sup> / Free CFC's / Zero ODP-GWP									
<b>Capacidad</b> Capacity [L] Capacité	M0, M1, M2: 951 H1: 801	M0, M1, M2: 1427 H1: 1202	M0, M1, M2: 1903 H1: 1601	M0, M1, M2: 2378 H1: 2003	M0, M1, M2: 2854 H1: 2404					
<b>Superficie exposición</b> Surface exhibition [x m <sup>2</sup> ] Surface d'exposition	M0, M1, M2: 4,76 H1: 4,01	M0, M1, M2: 7,10 H1: 6,10	M0, M1, M2: 9,50 H1: 8,10	M0, M1, M2: 11,9 H1: 10,1	M0, M1, M2: 14,3 H1: 12,1					
<b>Niveles Exposición</b> Exposition Levels Niveaux d'exposition	M0, M1, M2: 5+Expos. H1: 4+Expos.									
<b>Costados [2]</b> Sides [2] [mm] Joues [2]	40 + 40									
<b>Puertas</b> Doors Portes	2	3	4	5	6					
<b>Sistema de frío</b> Cooling System Système de froid	Ventilado / Ventilated / Ventilé									
<b>Desescarche</b> Defrost Dégivrage	Automático / Automatic / Automatique									
<b>Evaporación</b> Evaporation Évaporation	Forzada / Forced / Ventilé									
<b>Potencia</b> Power [W] Puissance	-									
<b>Potencia fríg.</b> Cooling capacity [W A -10°C] Puissance Frig.	M0: 1018 M2: 816	M1: 928 H1: 683	M0: 1596 M2: 1224	M1: 1391 H1: 1024	M0: 2035 M2: 1633	M1: 1855 H1: 1365	M0: 2544 M2: 2041	M1: 2319 H1: 1706	M0: 3053 M2: 2449	M1: 2783 H1: 2048
<b>Consumo</b> Consumption [kWh/ 24h] Consommation	-									
<b>Refrigerante</b> Refrigerant Gaz	<b>FREON</b>									
<b>Colores estándar</b> Standard colors Couleurs standard	<b>Ext. Estándar / Standar / Standard</b>			<b>Int. Estándar / Standar / Standard</b>						
<b>Laterales disponibles</b> Available sides Joues disponibles	Blanco/White/ Blanc	Ral 1015	Ral 1018	Blanco/White/ Blanc	Negro/Black/ Noir	Ral 7016				
	Ral 2003	Ral 3003	Ral 3020	No Incluidos / Not includes / Non inclus						
<b>Opciones pág. 426-427</b> Options pages 426-427 Options pages 426-427	Ral 5015	Ral 5017	Ral 5011	 Lateral Espejo Mirror end panels Joue Miroir						
	Ral 6002	Ral 6018	Ral 6019				 Lat. Panorámico Panoramic end panels Joue panoramique			
	Ral 7035	Ral 7037	Ral 7042	 Lateral Display Display end panels Joue Display						
	Ral 7016	Ral 9006	Negro/Black/ Noir							



Serie / Series / Série **MDG (PORTLAND)**

+Info: [www.infrico.com](http://www.infrico.com)

MX37DG22 M2



MX37DG22 H1

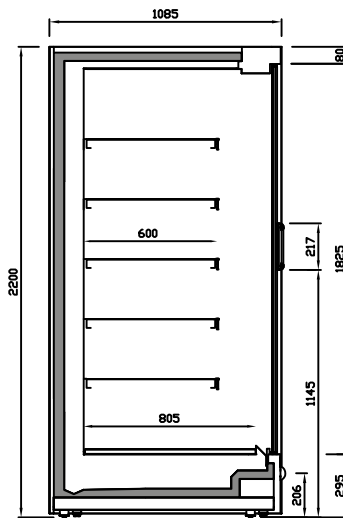

MX DG22 M0/M1/M2

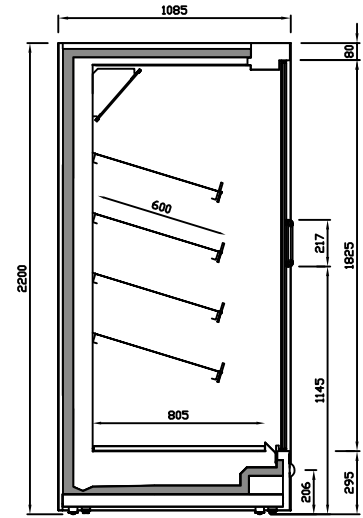

MX DG22 H1



Las fotografías que están en esta página son solo una muestra de las fotografías que se han tomado en las tiendas de Infrico. Los precios y las ofertas que se muestran en las fotografías pueden estar sujetos a cambios sin previo aviso. Los precios y las ofertas que se muestran en las fotografías pueden estar sujetos a cambios sin previo aviso. Les photos qui sont dans cette page ne sont que des exemples de photos prises dans les magasins Infrico. Les prix et les promotions indiqués dans les photos peuvent être sujets à modification sans préavis. Les prix et les promotions indiqués dans les photos peuvent être sujets à modification sans préavis.

# Murales Mixtas de refrigeración cerradas

## Mixed refrigeration doors multideck

### Murales mixtes fermées groupe à distance



MODELO MODELE MODÈLE				
Precio Price Prix	<b>M1</b>			
MOD.	<b>MS12 DGU M2</b>	<b>MS18 DGU M2</b>	<b>MS25 DGU M2</b>	<b>MS37 DGU M2</b>
Precio Price Prix	<b>M2</b>			
MOD.	<b>MS12 DGU H1</b>	<b>MS18 DGU H1</b>	<b>MS25 DGU H1</b>	<b>MS37 DGU H1</b>
Precio Price Prix	<b>H1</b>			
Medidas / Mesures / Mesuras / (mm)	1250 x 680 x 2050 mm.	1875 x 680 x 2050 mm.	2500 x 680 x 2050 mm.	3750 x 680 x 2050 mm.
Sin costados / Without sides / Sans joues				
T°. Prod.   Aplic. Prod. T°.   Applic. T°. (°C) Temp. Prod.   Temp. Appliq.	<b>M1: -1/+5°C   0/+2°C M2: -1/+7°C   +2/+4°C H1: +1/+10°C   +4/+6°C</b>			
Clase Climática Climatic class Classe climatique (°C)	3 / 25°C			
Tensión/Frecuencia Electrical data Tension électrique	230V/1ph/50Hz			
Controlador Controller Régulateur	Digital			
Material Material Matériel (EXT/INT)	Acero galvanizado plastificado / Plastified galvanised steel / Acier galvanisé plastifié			
Aislamiento Isolation Isolation (mm)	40kg/m <sup>3</sup> / Free CFC's / Zero ODP-GWP			
Capacidad Capacity Capacité (L)	M1, M2: 401 H1: 326	M1, M2: 602 H1: 489	M1, M2: 803 H1: 653	M1, M2: 1204 H1: 979
Superficie exposición Surface exhibition Surface d'exposition (x m <sup>2</sup> )	M1, M2: 2,01 H1: 1,64	M1, M2: 3,02 H1: 2,46	M1, M2: 4,02 H1: 3,27	M1, M2: 6,04 H1: 4,91
Niveles Exposición Exposition Levels Niveaux d'exposition	M1, M2: 4+Expos. H1: 3+Expos.			
Costados (2) Sides (2) Joues (2) (mm)	40 + 40			
Puertas Doors Portes	2	3	4	6
Sistema de frío Cooling System Système de froid	Ventilado / Ventilated / Ventilé			
Desescarche Defrost Dégivrage	Automático / Automatic / Automatique			
Evaporación Evaporation Évaporation	Forzada / Forced / Ventilé			
Potencia Power Puissance (W)	M1: 665 M2: 665 H1: 665	M1: 772 M2: 772 H1: 772	M1: 1147 M2: 1147 H1: 1147	M1: 2270 M2: 2270 H1: 2270
Potencia frig. Cooling capacity Puissance Frig. (W A -10°C)	-			
Consumo Consumption Consommation (kWh/ 24h)	M1: 11.7 M2: 10.9 H1: 10.4	M1: 13.1 M2: 12.6 H1: 12.0	M1: 19.8 M2: 18.7 H1: 17.8	M1: 38.1 M2: 37.1 H1: 35.41
Refrigerante Refrigerant Gaz	<b>R290</b>			
Colores estándar Standar colors Couleurs standard	Int. Estándar / Standar / Standard		Laterales / Sides / Joues	
	Blanco/White/ Blanc	Negro/Black/ Noir	Ral 7016	No Incluidos / Not includes / Non inclus
Laterales disponibles Available sides Joues disponibles	Ext. Estándar / Standar / Standard			
	Blanco/White/ Blanc	Ral 1015	Ral 1018	
Opciones pág. 426-427 Options pages 426-427 Options pages 426-427	Ral 2003	Ral 3003	Ral 3020	
	Ral 5015	Ral 5017	Ral 5011	
	Ral 6002	Ral 6018	Ral 6019	
	Ral 7035	Ral 7037	Ral 7042	
	Ral 7016	Ral 9006	Negro/Black/ Noir	
Lateral Espejo Mirror end panels Joue Miroir	Lat. Panorámico Panoramic end panels Joue panoramique	Lateral Display Display end panels Joue Display		



Serie / Series / Série **MDGU (DETROIT)**

+Info: [www.infrico.com](http://www.infrico.com)



MS37DGU M2



**Nuevo  
paragolpes  
frontal**

**New  
front  
bumper**

**Nouveau  
pare-chocs  
frontale**



MS25DGU H1

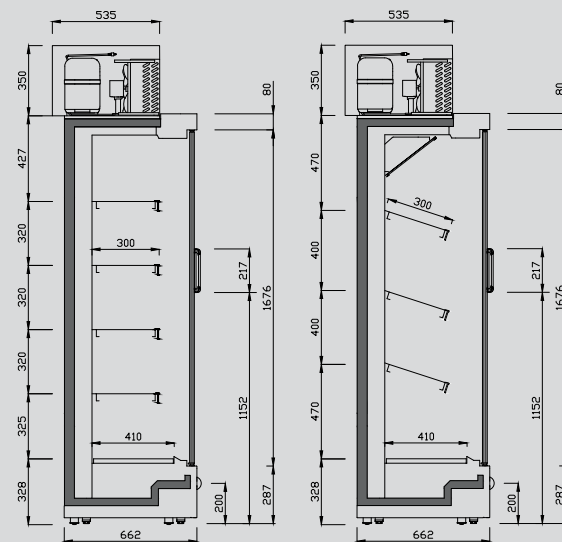

MS DGU M1/M2

MS DGU H1









# Murales Mixtas de refrigeración cerradas

## Mixed refrigeration doors multideck

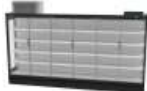
### Murales mixtes fermées groupe à distance

**N: 785**

MODELO MODELE MODÈLE				
<b>Precio</b> Price Prix	<b>M1</b>			
<b>MOD.</b>	<b>MN12 DGU M2</b>	<b>MN18 DGU M2</b>	<b>MN25 DGU M2</b>	<b>MN37 DGU M2</b>
<b>Precio</b> Price Prix	<b>M2</b>			
<b>MOD.</b>	<b>MN12 DGU H1</b>	<b>MN18 DGU H1</b>	<b>MN25 DGU H1</b>	<b>MN37 DGU H1</b>
<b>Precio</b> Price Prix	<b>H1</b>			
<b>Medidas / Measures /</b> Mesuras / (mm) <b>Sin costados / Without</b> sides / Sans joues	1250 x 785 x 2050 mm.	1875 x 785 x 2050 mm.	2500 x 785 x 2050 mm.	3750 x 785 x 2050 mm.
<b>T°. Prod.   Aplic.</b> Prod. T°.   Applic. T°. (°C) Temp. Prod.   Temp. Appliq.	<b>M1: -1/+5°C   0/+2°C    M2: -1/+7°C   +2/+4°C    H1: +1/+10°C   +4/+6°C</b>			
<b>Clase Climática</b> Climatic class Classe climatique (°C)	3 / 25°C			
<b>Tensión/Frecuencia</b> Electrical data Tension électrique	230V/1ph/50Hz			
<b>Controlador</b> Controller Régulateur	Digital			
<b>Material</b> Material Matériel (EXT/INT)	Acero galvanizado plastificado / Plastified galvanised steel / Acier galvanisé plastifié			
<b>Aislamiento</b> Isolation Isolation (mm)	40kg/m³ / Free CFC's / Zero ODP-GWP			
<b>Capacidad</b> Capacity Capacité (L)	M0, M1, M2: 766 H1: 655	M0, M1, M2: 1149 H1: 983	M0, M1, M2: 1533 H1: 1310	M0, M1, M2: 2299 H1: 1965
<b>Superficie exposición</b> Surface exhibition Surface d'exposition (x m²)	M1, M2: 2,64 H1: 2,14	M1, M2: 3,36 H1: 3,21	M1, M2: 5,28 H1: 4,30	M1, M2: 7,91 H1: 6,40
<b>Niveles Exposición</b> Exposition Levels Niveaux d'exposition	M1, M2: 4+Expos. H1: 3+Expos.			
<b>Costados (2)</b> Sides (2) Joues (2) (mm)	40 + 40			
<b>Puertas</b> Doors Portes	2	3	4	6
<b>Sistema de frío</b> Cooling System Système de froid	Ventilado / Ventilated / Ventilé			
<b>Desescarche</b> Defrost Dégivrage	Automático / Automatic / Automatique			
<b>Evaporación</b> Evaporation Évaporation	Forzada / Forced / Ventilé			
<b>Potencia</b> Power Puissance (W)	M1: 746    M2: 721 H1: 721	M1: 875    M2: 875 H1: 875	M1: 1272    M2: 1272 H1: 1272	M1: 2472    M2: 2472 H1: 2472
<b>Potencia frig.</b> Cooling capacity Puissance Frig. (W A -10°C)	-			
<b>Consumo</b> Consumption Consommation (kWh/ 24h)	M1: 12.5    M2: 11.6 H1: 10.4	M1: 14.7    M2: 13.6 H1: 12.2	M1: 21.4    M2: 19.8 H1: 17.7	M1: 35.6    M2: 32.6 H1: 29.7
<b>Refrigerante</b> Refrigerant Gaz	<b>R290</b>			
<b>Colores estándar</b> Standar colors Couleurs standard	<b>Int. Estándar / Standar / Standard</b>		<b>Laterales / Sides / Joues</b>	
	Blanco/White/ Blanc	Negro/Black/ Noir	Ral 7016	<b>No Incluidos / Not includes / Non inclus</b>
<b>Laterales disponibles</b> Available sides Joues disponibles	<b>Ext. Estándar / Standar / Standard</b>			
	Blanco/White/ Blanc	Ral 1015	Ral 1018	
<b>Opciones pág. 426-427</b> Options pages 426-427 Options pages 426-427	Ral 2003	Ral 3003	Ral 3020	
	Ral 5015	Ral 5017	Ral 5011	
	Ral 6002	Ral 6018	Ral 6019	
	Ral 7035	Ral 7037	Ral 7042	
	Ral 7016	Ral 9006	Negro/Black/ Noir	
	  			
	<p>Lateral Espejo Mirror end panels Joue Miroir</p> <p>Lat. Panorámico Panoramic end panels Joue panoramique</p> <p>Lateral Display Display end panels Joue Display</p>			

10



Serie / Series / Série **MDGU (DETROIT)**

+Info: [www.infrico.com](http://www.infrico.com)



MN25DGU H1



**Nuevo  
paragolpes  
frontal**

**New  
front  
bumper**

**Nouveau  
pare-chocs  
frontale**



MN37DGU M2

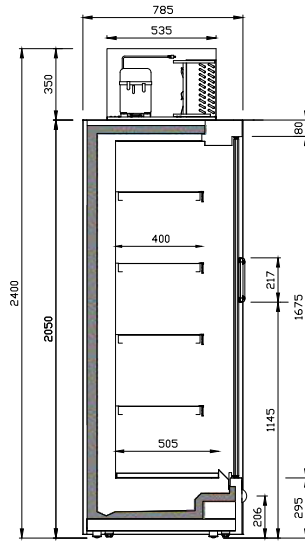

MN DGU M1/M2

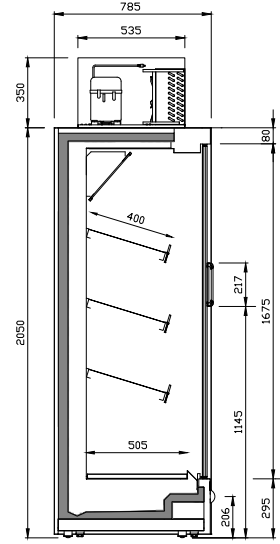

MN DGU H1







# Murales Mixtas de refrigeración cerradas

## Mixed refrigeration doors multideck

### Murales mixtes fermées groupe à distance

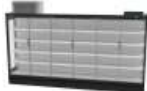

MODELO MODELE MODÈLE				
<b>Precio</b> Price Prix	<b>M1</b>			
<b>MOD.</b>	<b>ML12 DGU M2</b>	<b>ML18 DGU M2</b>	<b>ML25 DGU M2</b>	<b>ML37 DGU M2</b>
<b>Precio</b> Price Prix	<b>M2</b>			
<b>MOD.</b>	<b>ML12 DGU H1</b>	<b>ML18 DGU H1</b>	<b>ML25 DGU H1</b>	<b>ML37 DGU H1</b>
<b>Precio</b> Price Prix	<b>H1</b>			
<b>Medidas / Measures / Mesuras</b> / (mm) <b>Sin costados / Without sides / Sans joues</b>	1250 x 885 x 2050 mm.	1875 x 885 x 2050 mm.	2500 x 885 x 2050 mm.	3750 x 885 x 2050 mm.
<b>T°. Prod.   Aplic.</b> Prod. T°.   Applic. T°. (°C) Temp. Prod.   Temp. Appliq.	<b>M1: -1/+5°C   0/+2°C    M2: -1/+7°C   +2/+4°C    H1: +1/+10°C   +4/+6°C</b>			
<b>Clase Climática</b> Climatic class Classe climatique (°C)	3 / 25°C			
<b>Tensión/Frecuencia</b> Electrical data Tension électrique	230V/1ph/50Hz			
<b>Controlador</b> Controller Régulateur	Digital			
<b>Material</b> Material Matériel (EXT/INT)	Acero galvanizado plastificado / Plastified galvanised steel / Acier galvanisé plastifié			
<b>Aislamiento</b> Isolation Isolation (mm)	40kg/m <sup>3</sup> / Free CFC's / Zero ODP-GWP			
<b>Capacidad</b> Capacity Capacité (L)	803	1204	1605	2408
<b>Superficie exposición</b> Surface exhibition Surface d'exposition (x m <sup>2</sup> )	2,76	4,13	5,51	8,30
<b>Niveles Exposición</b> Exposition Levels Niveaux d'exposition	M1, M2: 4+Expos. H1: 3+Expos.			
<b>Costados (2)</b> Sides (2) Joues (2) (mm)	40 + 40			
<b>Puertas</b> Doors Portes	2	3	4	6
<b>Sistema de frío</b> Cooling System Système de froid	Ventilado / Ventilated / Ventilé			
<b>Desescarche</b> Defrost Dégivrage	Automático / Automatic / Automatique			
<b>Evaporación</b> Evaporation Évaporation	Forzada / Forced / Ventilé			
<b>Potencia</b> Power Puissance (W)	M1: 746    M2: 746 H1: 746	M1: 875    M2: 875 H1: 875	M1: 1272    M2: 1272 H1: 1272	M1: 2472    M2: 2472 H1: 2472
<b>Potencia frig.</b> Cooling capacity Puissance Frig. (W A -10°C)	-			
<b>Consumo</b> Consumption Consommation (kWh/ 24h)	M1: 12.5    M2: 11.6 H1: 10.4	M1: 14.7    M2: 13.6 H1: 12.2	M1: 21.4    M2: 19.8 H1: 17.7	M1: 35.6    M2: 32.6 H1: 29.7
<b>Refrigerante</b> Refrigerant Gaz	<b>R290</b>			
<b>Colores estándar</b> Standar colors Couleurs standard	<b>Int. Estándar / Standar / Standard</b>		<b>Laterales / Sides / Joues</b>	
	Blanco/White/ Blanc	Negro/Black/ Noir	No Incluidos / Not includes / Non inclus	
<b>Laterales disponibles</b> Available sides Joues disponibles	<b>Ext. Estándar / Standar / Standard</b>		 Lateral Espejo Mirror end panels Joue Miroir	
	Blanco/White/ Blanc	Ral 1015		
<b>Opciones pág. 426-427</b> Options pages 426-427 Options pages 426-427	Ral 2003	Ral 3003	 Lateral Display Display end panels Joue Display	
	Ral 5015	Ral 5017		
	Ral 6002	Ral 6018		
	Ral 7035	Ral 7037		
	Ral 7016	Ral 9006	Negro/Black/ Noir	



Serie / Series / Série **MDGU (DETROIT)**

+Info: [www.infrico.com](http://www.infrico.com)

ML37DGU M2



Nuevo  
paragolpes  
frontal

New  
front  
bumper

Nouveau  
pare-chocs  
frontale



ML25DGU H1

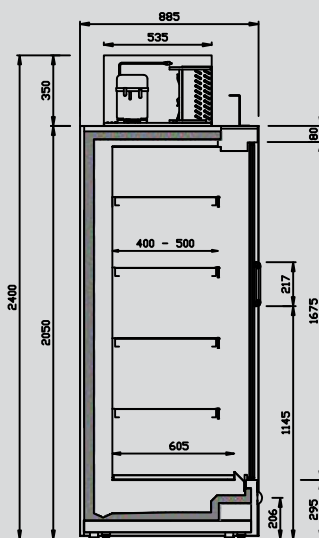

ML DGU M1/M2

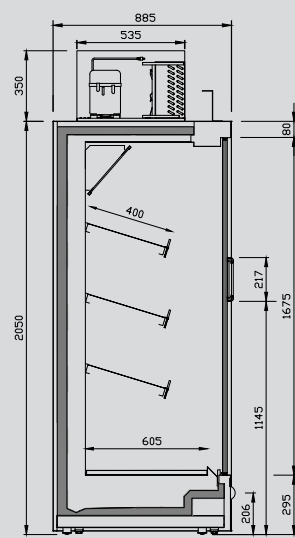

ML DGU H1



# Murales Mixtas de refrigeración cerradas

## Mixed refrigeration doors multideck

### Murales mixtes fermées groupe à distance



MODELO MODELE MODÈLE				
Precio Price Prix	<b>M1</b>			
MOD.	<b>ML12 DGU22 M2</b>	<b>ML18 DGU22 M2</b>	<b>ML25 DGU22 M2</b>	<b>ML37 DGU22 M2</b>
Precio Price Prix	<b>M2</b>			
MOD.	<b>ML12 DGU22 H1</b>	<b>ML18 DGU22 H1</b>	<b>ML25 DGU22 H1</b>	<b>ML37 DGU22 H1</b>
Precio Price Prix	<b>H1</b>			
Medidas / Measures / Mesures / (mm)	1250 x 885 x 2200 mm.	1875 x 885 x 2200 mm.	2500 x 885 x 2200 mm.	3750 x 885 x 2200 mm.
Sin costados / Without sides / Sans joues				
T°. Prod.   Aplic. Prod. T°.   Applic. T°. (°C) Temp. Prod.   Temp. Appliq.	<b>M1: -1/+5°C   0/+2°C    M2: -1/+7°C   +2/+4°C    H1: +1/+10°C   +4/+6°C</b>			
Clase Climática Climatic class Classe climatique (°C)	3 / 25°C			
Tensión/Frecuencia Electrical data Tension électrique	230V/1ph/50Hz			
Controlador Controller Régulateur	Digital			
Material Material (EXT/INT) Matériel	Acero galvanizado plastificado / Plastified galvanised steel / Acier galvanisé plastifié			
Aislamiento Isolation Isolation (mm)	40kg/m <sup>3</sup> / Free CFC's / Zero ODP-GWP			
Capacidad Capacity Capacité (L)	M1, M2: 1046 H1: 890	M1, M2: 1569 H1: 1335	M1, M2: 2092 H1: 1779	M1, M2: 3138 H1: 2669
Superficie exposición Surface exhibition Surface d'exposition (x m <sup>2</sup> )	3,26	4,88	6,51	9,70
Niveles Exposición Exposition Levels Niveaux d'exposition	M1, M2: 5+Expos. H1: 4+Expos.			
Costados (2) Sides (2) Joues (2) (mm)	40 + 40			
Puertas Doors Portes	2	3	4	6
Sistema de frío Cooling System Système de froid	Ventilado / Ventilated / Ventilé			
Desescarche Defrost Dégivrage	Automático / Automatic / Automatique			
Evaporación Evaporation Évaporation	Forzada / Forced / Ventilé			
Potencia Power Puissance (W)	M1: 746    M2: 746 H1: 746	M1: 875    M2: 875 H1: 875	M1: 1285    M2: 1285 H1: 1285	M1: 2422    M2: 2422 H1: 2422
Potencia frig. Cooling capacity Puissance Frig. (W A -10°C)	-			
Consumo Consumption Consommation (kWh/ 24h)	M1: 12.8    M2: 11.8 H1: 10.61	M1: 14.9    M2: 13.8 H1: 12.4	M1: 21.8    M2: 20.3 H1: 18.1	M1: 36.1    M2: 33.3 H1: 30.3
Refrigerante Refrigerant Gaz	<b>R290</b>			
Colores estándar Standar colors Couleurs standard	Int. Estándar / Standar / Standard		Laterales / Sides / Joues	
	Blanco/White/ Blanc	Negro/Black/ Noir	Ral 7016	No Incluidos / Not includes / Non inclus
Laterales disponibles Available sides Joues disponibles	Ext. Estándar / Standar / Standard			
	Blanco/White/ Blanc	Ral 1015	Ral 1018	
Opciones pág. 426-427 Options pages 426-427 Options pages 426-427	Ral 2003	Ral 3003	Ral 3020	
	Ral 5015	Ral 5017	Ral 5011	
	Ral 6002	Ral 6018	Ral 6019	
	Ral 7035	Ral 7037	Ral 7042	
	Ral 7016	Ral 9006	Negro/Black/ Noir	



Serie / Series / Série **MDGU (DETROIT)**

+Info: [www.infrico.com](http://www.infrico.com)

ML37DGU22 M2



ML25DGU22 H1

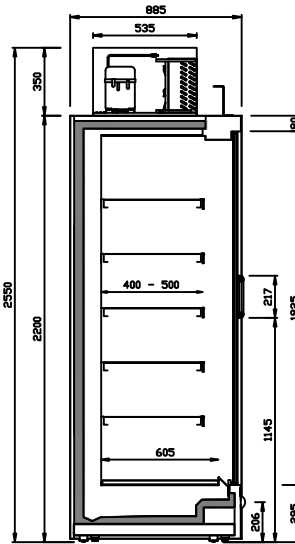

ML DGU22 M1/M2

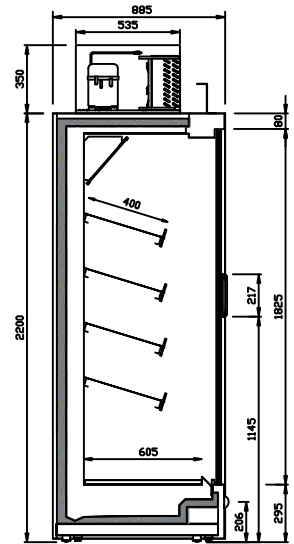

ML DGU22 H1



# Mural remota de refrigeración abierta frente bajo

## Remote refrigeration open low front multidecks

### Murale de réfrigération ouverte groupe à distance avec frontal bas

N: 785

MODELO MODELE MODÈLE	MN9 PB M1	MN12 PB M1	MN18 PB M1	MN25 PB M1	MN37 PB M1	
Precio Price Prix	<b>M1</b>					
MOD.	<b>MN9 PB M2</b>	<b>MN12 PB M2</b>	<b>MN18 PB M2</b>	<b>MN25 PB M2</b>	<b>MN37 PB M2</b>	
Precio Price Prix	<b>M2</b>					
MOD.	<b>MN9 PB H1</b>	<b>MN12 PB H1</b>	<b>MN18 PB H1</b>	<b>MN25 PB H1</b>	<b>MN37 PB H1</b>	
Precio Price Prix	<b>H1</b>					
Medidas / Measures / Mesures / (mm)	938 x 785 x 2050 mm.	1250 x 785 x 2050 mm.	1875 x 785 x 2050 mm.	2500 x 785 x 2050 mm.	3750 x 785 x 2050 mm.	
Sin costados / Without sides / Sans joues						
T°. Prod.   Aplic. Prod. T°.   Applic. T°. (°C) Temp. Prod.   Temp. Appliq.	<b>M1: -1/+5°C   0/+2°C    M2: -1/+7°C   +2/+4°C    H1: +1/+10°C   +4/+6°C</b>					
Clase Climática Climatic class Classe climatique (°C)	3 / 25°C					
Tensión/Frecuencia Electrical data Tension électrique	230V/1ph/50Hz					
Controlador Controller Régulateur	Digital					
Material Material Matériel (EXT/INT)	Acero galvanizado plastificado / Plastified galvanised steel / Acier galvanisé plastifié					
Aislamiento Isolation Isolation (mm)	40kg/m³ / Free CFC's / Zero ODP-GWP					
Capacidad Capacity Capacité (L)	M1, M2: 575 H1: 492	M1, M2: 766 H1: 655	M1, M2: 1149 H1: 983	M1, M2: 1533 H1: 1310	M1, M2: 2299 H1: 1965	
Superficie exposición Surface exhibition Surface d'exposition (x m²)	M1, M2: 1,98 H1: 1,60	M1, M2: 2,64 H1: 2,14	M1, M2: 3,96 H1: 3,21	M1, M2: 5,28 H1: 4,28	M1, M2: 7,91 H1: 6,41	
Niveles Exposición Exposition Levels Niveaux d'exposition	M1, M2: 4+Expos. H1: 3+Expos.					
Costados (2) Sides (2) Joues (2) (mm)	40 + 40					
Puertas Doors Portes	-					
Sistema de frío Cooling System Système de froid	Ventilado / Ventilated / Ventilé					
Desescarche Defrost Dégivrage	Automático / Automatic / Automatique					
Evaporación Evaporation Évaporation	Forzada / Forced / Ventilé					
Potencia Power Puissance (W)	-					
Potencia frig. Cooling capacity Puissance Frig. (W A -10°C)	M1: 1780 M2: 1636 H1: 1366	M1: 2373 M2: 2180 H1: 1820	M1: 3559 M2: 3270 H1: 2730	M1: 4745 M2: 4360 H1: 3640	M1: 7118 M2: 6540 H1: 5460	
Consumo Consumption Consommation (kWh/ 24h)	-					
Refrigerante Refrigerant Gaz	<b>FREON</b>					
Colores estándar Standar colors Couleurs standard	Int. Estándar / Standar / Standard		Laterales / Sides / Joues			
	Blanco/White/ Blanc	Negro/Black/ Noir	Ral 7016	No Incluidos / Not includes / Non inclus		
Laterales disponibles Available sides Joues disponibles	Ext. Estándar / Standar / Standard					
	Blanco/White/ Blanc	Ral 1015	Ral 1018			
Opciones pág. 426-427 Options pages 426-427 Options pages 426-427	Ral 2003	Ral 3003	Ral 3020			
	Ral 5015	Ral 5017	Ral 5011			
	Ral 6002	Ral 6018	Ral 6019			
	Ral 7035	Ral 7037	Ral 7042			
	Ral 7016	Ral 9006	Negro/Black/ Noir			



Lateral Espejo  
Mirror end panels  
Joue Miroir



Lat. Panorámico  
Panoramic end panels  
Joue panoramique



Lateral Display  
Display end panels  
Joue Display

Serie / Series / Série **MPB (OSLO)**

+Info: [www.infrico.com](http://www.infrico.com)

MN25PB H1



**Nuevo  
paragolpes  
frontal**

**New  
front  
bumper**

**Nouveau  
pare-chocs  
frontale**



MN37PB M2

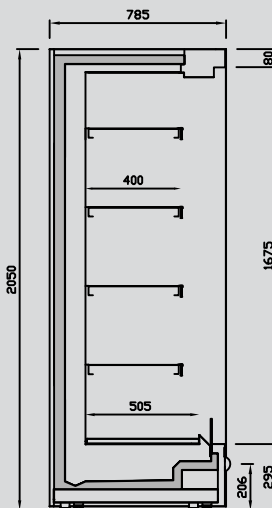

MN PB M1/M2

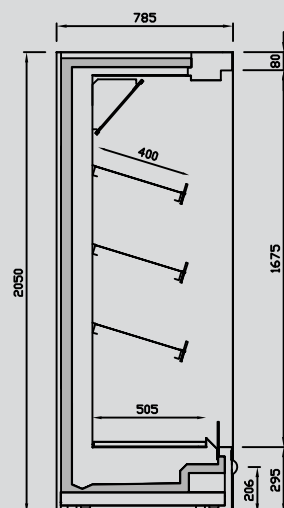

MN PB H1



# Mural remota de refrigeración abierta frente bajo

## Remote refrigeration open low front multidecks

### Murale de réfrigération ouverte groupe à distance avec frontal bas

N: 785

MODELO MODELE MODÈLE	MN9 PB22 M1	MN12 PB22 M1	MN18 PB22 M1	MN25 PB22 M1	MN37 PB22 M1	
Precio Price Prix	<b>M1</b>					
MOD.	<b>MN9 PB22 M2</b>	<b>MN12 PB22 M2</b>	<b>MN18 PB22 M2</b>	<b>MN25 PB22 M2</b>	<b>MN37 PB22 M2</b>	
Precio Price Prix	<b>M2</b>					
MOD.	<b>MN9 PB22 H1</b>	<b>MN12 PB22 H1</b>	<b>MN18 PB22 H1</b>	<b>MN25 PB22 H1</b>	<b>MN37 PB22 H1</b>	
Precio Price Prix	<b>H1</b>					
Medidas / Measures / Mesures / (mm)	938 x 785 x 2200 mm.	1250 x 785 x 2200 mm.	1875 x 785 x 2200 mm.	2500 x 785 x 2200 mm.	3750 x 785 x 2200 mm.	
Sin costados / Without sides / Sans joues						
T°. Prod.   Aplic. Prod. T°.   Applic. T°. (°C) Temp. Prod.   Temp. Appliq.	<b>M1: -1/+5°C   0/+2°C    M2: -1/+7°C   +2/+4°C    H1: +1/+10°C   +4/+6°C</b>					
Clase Climática Climatic class Classe climatique (°C)	3 / 25°C					
Tensión/Frecuencia Electrical data Tension électrique	230V/1ph/50Hz					
Controlador Controller Régulateur	Digital					
Material Material Matériel (EXT/INT)	Acero galvanizado plastificado / Plastified galvanised steel / Acier galvanisé plastifié					
Aislamiento Isolation Isolation (mm)	40kg/m <sup>3</sup> / Free CFC's / Zero ODP-GWP					
Capacidad Capacity Capacité (L)	M1, M2: 579 H1: 496	M1, M2: 771 H1: 660	M1, M2: 1156 H1: 991	M1, M2: 1542 H1: 1322	M1, M2: 2313 H1: 1983	
Superficie exposición Surface exhibition Surface d'exposition (x m <sup>2</sup> )	M1, M2: 2,35 H1: 1,95	M1, M2: 3,13 H1: 2,63	M1, M2: 4,70 H1: 3,95	M1, M2: 6,30 H1: 5,30	M1, M2: 9,40 H1: 7,90	
Niveles Exposición Exposition Levels Niveaux d'exposition	M1, M2: 5+Expos. H1: 4+Expos.					
Costados (2) Sides (2) Joues (2) (mm)	40 + 40					
Puertas Doors Portes	-					
Sistema de frío Cooling System Système de froid	Ventilado / Ventilated / Ventilé					
Desescarche Defrost Dégivrage	Automático / Automatic / Automatique					
Evaporación Evaporation Évaporation	Forzada / Forced / Ventilé					
Potencia Power Puissance (W)	-					
Potencia frig. Cooling capacity Puissance Frig. (W A -10°C)	M1: 2092 M2: 1907 H1: 1521	M1: 2788 M2: 2541 H1: 2028	M1: 4181 M2: 3812 H1: 3041	M1: 5575 M2: 5083 H1: 4055	M1: 8363 M2: 7624 H1: 6083	
Consumo Consumption Consommation (kWh/ 24h)	-					
Refrigerante Refrigerant Gaz	<b>FREON</b>					
Colores estándar Standar colors Couleurs standard	Int. Estándar / Standar / Standard		Laterales / Sides / Joues			
	Blanco/White/ Blanc	Negro/Black/ Noir	Ral 7016	No Incluidos / Not includes / Non inclus		
Laterales disponibles Available sides Joues disponibles	Ext. Estándar / Standar / Standard					
	Blanco/White/ Blanc	Ral 1015	Ral 1018			
Opciones pág. 426-427 Options pages 426-427 Options pages 426-427	Ral 2003	Ral 3003	Ral 3020			
	Ral 5015	Ral 5017	Ral 5011			
	Ral 6002	Ral 6018	Ral 6019			
	Ral 7035	Ral 7037	Ral 7042			
	Ral 7016	Ral 9006	Negro/Black/ Noir			

10



Lateral Espejo  
Mirror end panels  
Joue Miroir



Lat. Panorámico  
Panoramic end panels  
Joue panoramique



Lateral Display  
Display end panels  
Joue Display



Serie / Series / Série **MPB (OSLO)**

+Info: [www.infrico.com](http://www.infrico.com)

MN37PB22 M2



MN25PB22 H1

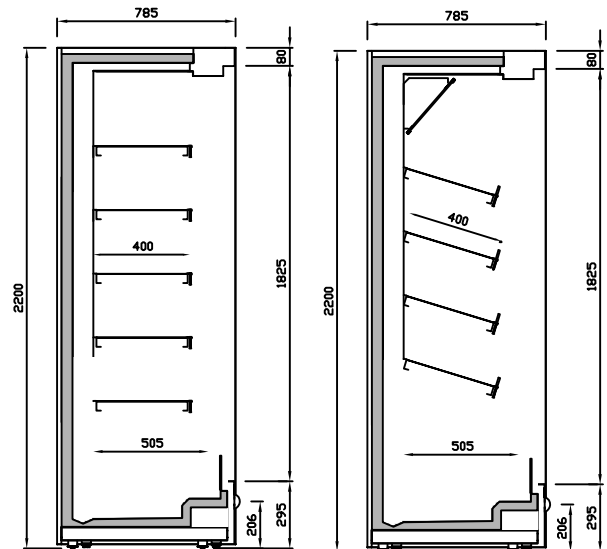

MN PB22 M1/M2

MN PB22 H1











# Mural remota de refrigeración abierta frente bajo

## Remote refrigeration open low front multidecks

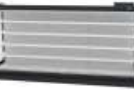
### Murale de réfrigération ouverte groupe à distance avec frontal bas



MODELO MODELE MODÈLE						
Precio Price Prix	<b>M1</b>					
MOD.	<b>ML9 PB M2</b>	<b>ML12 PB M2</b>	<b>ML18 PB M2</b>	<b>ML25 PB M2</b>	<b>ML31 PB M2</b>	<b>ML37 PB M2</b>
Precio Price Prix	<b>M2</b>					
MOD.	<b>ML9 PB H1</b>	<b>ML12 PB H1</b>	<b>ML18 PB H1</b>	<b>ML25 PB H1</b>	<b>ML31 PB H1</b>	<b>ML37 PB H1</b>
Precio Price Prix	<b>H1</b>					
Medidas / Measures / Mesures / (mm)	938 x 885 x 2050 mm.	1250 x 885 x 2050 mm.	1875 x 885 x 2050 mm.	2500 x 885 x 2050 mm.	3125 x 885 x 2050 mm.	3750 x 885 x 2050 mm.
Sin costados / Without sides / Sans joues						
T°. Prod.   Aplic. Prod. T°.   Applic. T°. (°C) Temp. Prod.   Temp. Appliq.	<b>M1: -1/+5°C   0/+2°C    M2: -1/+7°C   +2/+4°C    H1: +1/+10°C   +4/+6°C</b>					
Clase Climática Climatic class Classe climatique (°C)	3 / 25°C					
Tensión/Frecuencia Electrical data Tension électrique	230V/1ph/50Hz					
Controlador Controller Régulateur	Digital					
Material Material Matériel (EXT/INT)	Acero galvanizado plastificado / Plastified galvanised steel / Acier galvanisé plastifié					
Aislamiento Isolation Isolation (mm)	40kg/m <sup>3</sup> / Free CFC's / Zero ODP-GWP					
Capacidad Capacity Capacité (L)	M1, M2: 602 H1: 520	M1, M2: 803 H1: 701	M1, M2: 1204 H1: 1143	M1, M2: 1605 H1: 1390	M1, M2: 2012 H1: 1650	M1, M2: 2408 H1: 2110
Superficie exposición Surface exhibition Surface d'exposition (x m <sup>2</sup> )	M1, M2: 2,07 H1: 1,69	M1, M2: 2,76 H1: 2,26	M1, M2: 4,10 H1: 3,40	M1, M2: 5,50 H1: 4,50	M1, M2: 6,80 H1: 5,60	M1, M2: 8,30 H1: 6,70
Niveles Exposición Exposition Levels Niveaux d'exposition	M1, M2: 4+Expos. H1: 3+Expos.					
Costados (2) Sides (2) Joues (2) (mm)	40 + 40					
Puertas Doors Portes	-	-	-	-	-	-
Sistema de frío Cooling System Système de froid	Ventilado / Ventilated / Ventilé					
Desescarche Defrost Dégivrage	Automático / Automatic / Automatique					
Evaporación Evaporation Évaporation	Forzada / Forced / Ventilé					
Potencia Power Puissance (W)	-	-	-	-	-	-
Potencia frig. Cooling capacity Puissance Frig. (W A -10°C)	M1: 1696 M2: 1558 H1: 1300	M1: 2260 M2: 2076 H1: 1733	M1: 3190 M2: 3114 H1: 2599	M1: 4250 M2: 4153 H1: 3465	M1: 5650 M2: 5191 H1: 4331	M1: 6780 M2: 6229 H1: 5198
Consumo Consumption Consommation (kWh/ 24h)	-	-	-	-	-	-
Refrigerante Refrigerant Gaz	<b>FREON</b>					
Colores estándar Standar colors Couleurs standard	Int. Estándar / Standar / Standard			Laterales / Sides / Joues		
	Blanco/White/ Blanc	Negro/Black/ Noir	Ral 7016	No Incluidos / Not includes / Non inclus		
Laterales disponibles Available sides Joues disponibles	Ext. Estándar / Standar / Standard			 Lateral Espejo Mirror end panels Joue Miroir		
	Blanco/White/ Blanc	Ral 1015	Ral 1018			
Opciones pág. 426-427 Options pages 426-427 Options pages 426-427	Ral 2003	Ral 3003	Ral 3020	 Lateral Display Display end panels Joue Display		
	Ral 5015	Ral 5017	Ral 5011			
	Ral 6002	Ral 6018	Ral 6019			
	Ral 7035	Ral 7037	Ral 7042			
	Ral 7016	Ral 9006	Negro/Black/ Noir			

10

Serie / Series / Série **MPB (OSLO)**

+Info: [www.infrico.com](http://www.infrico.com)

ML37PB M2

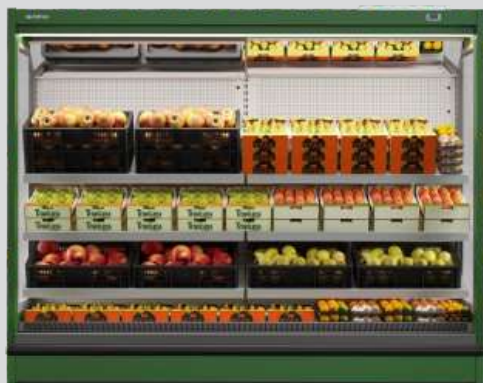

ML25PB H1

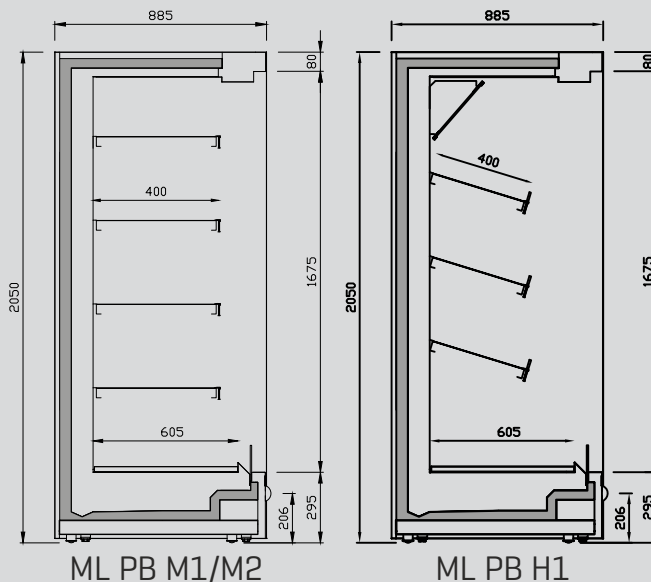

Los datos técnicos en el catálogo se basan en las condiciones más desfavorables que se dan en el momento de la publicación. Infrico no se hace responsable de los errores de impresión. Les données techniques peuvent varier et seront actualisées conformément aux données techniques du produit disponibles sur le site web.

# Mural remota de refrigeración abierta frente bajo

## Remote refrigeration open low front multidecks

### Murale de réfrigération ouverte groupe à distance avec frontal bas



MODELO MODELE MODÈLE	ML9 PB22 M1	ML12 PB22 M1	ML18 PB22 M1	ML25 PB22 M1	ML31 PB22 M1	ML37 PB22 M1
Precio Price Prix	<b>M1</b>					
MOD.	ML9 PB22 M2	ML12 PB22 M2	ML18 PB22 M2	ML25 PB22 M2	ML31 PB22 M2	ML37 PB22 M2
Precio Price Prix	<b>M2</b>					
MOD.	ML9 PB22 H1	ML12 PB22 H1	ML18 PB22 H1	ML25 PB22 H1	ML31 PB22 H1	ML37 PB22 H1
Precio Price Prix	<b>H1</b>					
Medidas / Measures / Mesures / (mm)	938 x 885 x 2200 mm.	1250 x 885 x 2200 mm.	1875 x 885 x 2200 mm.	2500 x 885 x 2200 mm.	3125 x 885 x 2200 mm.	3750 x 885 x 2200 mm.
Sin costados / Without sides / Sans joues						
T°. Prod.   Aplic. Prod. T°.   Applic. T°. (°C) Temp. Prod.   Temp. Appliq.	<b>M1: -1/+5°C   0/+2°C    M2: -1/+7°C   +2/+4°C    H1: +1/+10°C   +4/+6°C</b>					
Clase Climática Climatic class Classe climatique (°C)	3 / 25°C					
Tensión/Frecuencia Electrical data Tension électrique	230V/1ph/50Hz					
Controlador Controller Régulateur	Digital					
Material Material Matériel (EXT/INT)	Acero galvanizado plastificado / Plastified galvanised steel / Acier galvanisé plastifié					
Aislamiento Isolation Isolation (mm)	40kg/m <sup>3</sup> / Free CFC's / Zero ODP-GWP					
Capacidad Capacity Capacité (L)	M1, M2: 637 H1: 575	M1, M2: 849 H1: 742	M1, M2: 1273 H1: 1195	M1, M2: 1698 H1: 1480	M1, M2: 2105 H1: 1148	M1, M2: 2503 H1: 2205
Superficie exposición Surface exhibition Surface d'exposition (x m <sup>2</sup> )	M1, M2: 2,44 H1: 2,07	M1, M2: 3,30 H1: 2,70	M1, M2: 4,88 H1: 4,13	M1, M2: 6,50 H1: 5,50	M1, M2: 8,10 H1: 6,90	M1, M2: 9,70 H1: 8,30
Niveles Exposición Exposition Levels Niveaux d'exposition	M1, M2: 4+Expos. H1: 3+Expos.					
Costados (2) Sides (2) Joues (2) (mm)	40 + 40					
Puertas Doors Portes	-	-	-	-	-	-
Sistema de frío Cooling System Système de froid	Ventilado / Ventilated / Ventilé					
Desescarche Defrost Dégivrage	Automático / Automatic / Automatique					
Evaporación Evaporation Évaporation	Forzada / Forced / Ventilé					
Potencia Power Puissance (W)	-	-	-	-	-	-
Potencia frig. Cooling capacity Puissance Frig. (W A -10°C)	M1: 1889 M2:1816 H1: 1448	M1: 2650 M2: 2420 H1:1930	M1: 3975 M2:3630 H1: 2895	M1: 5300 M2:4840 H1:3860	M1:6625 M2: 6050 H1:4825	M1:7950 M2:7260 H1: 5790
Consumo Consumption Consommation (kWh/ 24h)	-	-	-	-	-	-
Refrigerante Refrigerant Gaz	<b>FREON</b>					
Colores estándar Standar colors Couleurs standard	Int. Estándar / Standar / Standard			Laterales / Sides / Joues		
	Blanco/White/ Blanc	Negro/Black/ Noir	Ral 7016	No Incluidos / Not includes / Non inclus		
Laterales disponibles Available sides Joues disponibles	Ext. Estándar / Standar / Standard					
	Blanco/White/ Blanc	Ral 1015	Ral 1018			
Ral 2003	Ral 3003	Ral 3020				
Ral 5015	Ral 5017	Ral 5011				
Ral 6002	Ral 6018	Ral 6019				
Ral 7035	Ral 7037	Ral 7042				
Opciones pág. 426-427 Options pages 426-427 Options pages 426-427	Ral 7016	Ral 9006	Negro/Black/ Noir			

Serie / Series / Série **MPB (OSLO)**

+Info: [www.infrico.com](http://www.infrico.com)

ML25PB22 H1



ML37PB22 M2

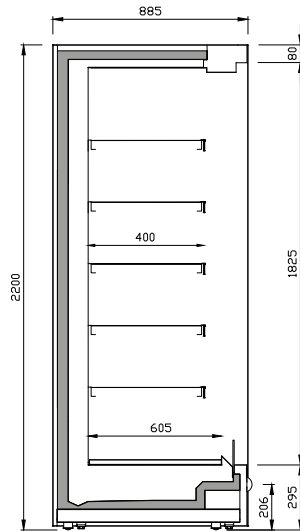

ML PB22 M1/M2

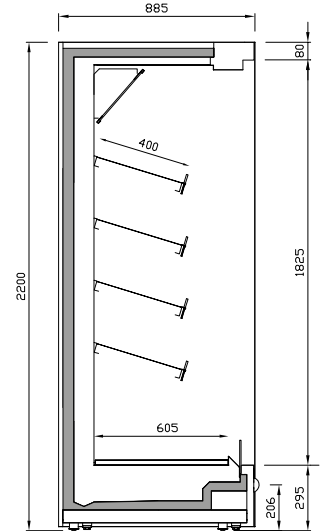

ML PB22 H1





# Mural remota de refrigeración abierta frente bajo

## Remote refrigeration open low front multidecks

### Murale de réfrigération ouverte groupe à distance avec frontal bas



MODELO MODELE MODÈLE					
Precio Price Prix	<b>M2</b>				
MOD.	<b>MX12 PB H1</b>	<b>MX18 PB H1</b>	<b>MX25 PB H1</b>	<b>MX31 PB H1</b>	<b>MX37 PB H1</b>
Precio Price Prix	<b>H1</b>				
Medidas / Measures / Mesures / (mm)	1250 x 1085	1875 x 1085	2500 x 1085	3125 x 1085	3750 x 1085
Sin costados / Without sides / Sans joues	x 2050 mm.				
T°. Prod.   Aplic. Prod. T°.   Applic. T°. (°C) Temp. Prod.   Temp. Appliq.	<b>M2: -1/+7°C   +2/+4°C</b> <b>H1: +1/+10°C   +4/+6°C</b>				
Clase Climática Climatic class Classe climatique (°C)	3 / 25°C				
Tensión/Frecuencia Electrical data Tension électrique	230V/1ph/50Hz				
Controlador Controller Régulateur	Digital				
Material Material Matériel (EXT/INT)	Acero galvanizado plastificado / Plastified galvanised steel / Acier galvanisé plastifié				
Aislamiento Isolation Isolation (mm)	40kg/m <sup>3</sup> / Free CFC's / Zero ODP-GWP				
Capacidad Capacity Capacité (L)	M2: 801 H1: 651	M2: 1202 H1: 976	M2: 1603 H1: 1303	M2: 2003 H1: 1628	M2: 2404 H1: 1954
Superficie exposición Surface exhibition Surface d'exposition (x m <sup>2</sup> )	M2: 4,01 H1: 3,26	M2: 6,01 H1: 4,28	M2: 8,01 H1: 6,50	M2: 10,1 H1: 8,20	M2: 12,1 H1: 9,70
Niveles Exposición Exposition Levels Niveaux d'exposition	M2: 4+Expos. H1: 3+Expos.				
Costados (2) Sides (2) Joues (2) (mm)	40 + 40				
Puertas Doors Portes	-				
Sistema de frío Cooling System Système de froid	Ventilado / Ventilated / Ventilé				
Desescarche Defrost Dégivrage	Automático / Automatic / Automatique				
Evaporación Evaporation Évaporation	Forzada / Forced / Ventilé				
Potencia Power Puissance (W)	-				
Potencia frig. Cooling capacity Puissance Frig. (W A -10°C)	M2: 2430 H1: 2028	M2: 3645 H1: 3041	M2: 4860 H1: 4055	M2: 6075 H1: 5069	M2: 7290 H1: 6083
Consumo Consumption Consommation (kWh/ 24h)	-				
Refrigerante Refrigerant Gaz	<b>FREON</b>				
Colores estándar Standar colors Couleurs standard	<b>Int. Estándar / Standar / Standard</b> Blanco/White/ Blanc    Negro/Black/ Noir    Ral 7016		<b>Laterales / Sides / Joues</b> No Incluidos / Not includes / Non inclus		
Laterales disponibles Available sides Joues disponibles	<b>Ext. Estándar / Standar / Standard</b> Blanco/White/ Blanc    Ral 1015    Ral 1018 Ral 2003    Ral 3003    Ral 3020 Ral 5015    Ral 5017    Ral 5011 Ral 6002    Ral 6018    Ral 6019 Ral 7035    Ral 7037    Ral 7042 Ral 7016    Ral 9006    Negro/Black/ Noir		  		
Opciones pág. 426-427 Options pages 426-427 Options pages 426-427					

10

MX37PB M2



MX25PB H1

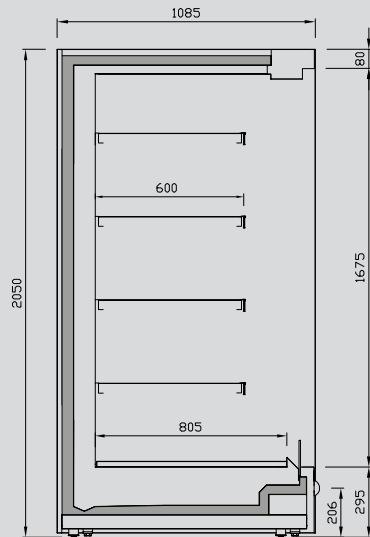

MX PB M2

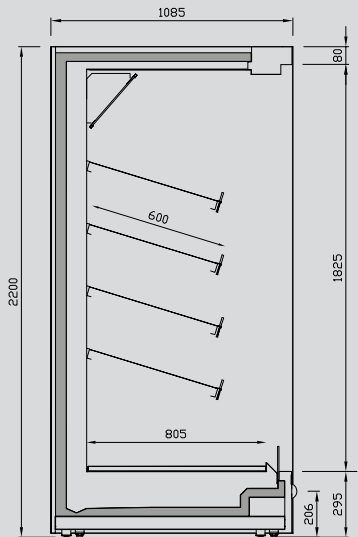

MX PB H1



Aspetos técnicos e de enclaves a plicables a relacións que coa información técnica de produtos que se expoñen.  
 I dati tecnici e di enclaves a plicabili a relazioni che con la informazione tecnica di prodotti che si espongono.  
 Les données techniques peuvent varier et seront actualisées conformément aux données techniques du produit, disponibles sur le site web.

# Mural remota de refrigeración abierta frente bajo

## Remote refrigeration open low front multidecks

### Murale de réfrigération ouverte groupe à distance avec frontal bas



MODELO MODELE MODÈLE					
Precio Price Prix	<b>M2</b>				
MOD.	<b>MX12 PB22 H1</b>	<b>MX18 PB22 H1</b>	<b>MX25 PB22 H1</b>	<b>MX31 PB22 H1</b>	<b>MX37 PB22 H1</b>
Precio Price Prix	<b>H1</b>				
Medidas / Measures / Mesures / (mm)	1250 x 1085	1875 x 1085	2500 x 1085	3125 x 1085	3750 x 1085
Sin costados / Without sides / Sans joues	x 2200 mm.				
T°. Prod.   Aplic. Prod. T°.   Applic. T°. (°C) Temp. Prod.   Temp. Appliq.	<b>M2: -1/+7°C   +2/+4°C</b> <b>H1: +1/+10°C   +4/+6°C</b>				
Clase Climática Climatic class Classe climatique (°C)	3 / 25°C				
Tensión/Frecuencia Electrical data Tension électrique	230V/1ph/50Hz				
Controlador Controller Régulateur	Digital				
Material Material Matériel (EXT/INT)	Acero galvanizado plastificado / Plastified galvanised steel / Acier galvanisé plastifié				
Aislamiento Isolation Isolation (mm)	40kg/m <sup>3</sup> / Free CFC's / Zero ODP-GWP				
Capacidad Capacity Capacité (L)	M2: 951 H1: 801	M2: 1427 H1: 1202	M2: 1903 H1: 1603	M2: 2378 H1: 2003	M2: 2854 H1: 2404
Superficie exposición Surface exhibition Surface d'exposition (x m <sup>2</sup> )	M2: 4,80 H1: 4,00	M2: 7,10 H1: 6,02	M2: 9,50 H1: 8,10	M2: 11,9 H1: 10,1	M2: 14,3 H1: 12,0
Niveles Exposición Exposition Levels Niveaux d'exposition	M1, M2: 5+Expos. H1: 4+Expos.				
Costados (2) Sides (2) Joues (2) (mm)	40 + 40				
Puertas Doors Portes	-				
Sistema de frío Cooling System Système de froid	Ventilado / Ventilated / Ventilé				
Desescarche Defrost Dégivrage	Automático / Automatic / Automatique				
Evaporación Evaporation Évaporation	Forzada / Forced / Ventilé				
Potencia Power Puissance (W)	-				
Potencia frig. Cooling capacity Puissance Frig. (W A -10°C)	M2: 2833 H1: 2259	M2: 4249 H1: 3388	M2: 5665 H1: 4518	M2: 7081 H1: 5647	M2: 8498 H1: 6776
Consumo Consumption Consommation (kWh/ 24h)	-				
Refrigerante Refrigerant Gaz	<b>FREON</b>				
Colores estándar Standar colors Couleurs standard	<b>Int. Estándar / Standar / Standard</b> Blanco/White/ Blanc    Negro/Black/ Noir    Ral 7016		<b>Laterales / Sides / Joues</b> No Incluidos / Not includes / Non inclus		
Laterales disponibles Available sides Joues disponibles	<b>Ext. Estándar / Standar / Standard</b> Blanco/White/ Blanc    Ral 1015    Ral 1018 Ral 2003    Ral 3003    Ral 3020 Ral 5015    Ral 5017    Ral 5011 Ral 6002    Ral 6018    Ral 6019 Ral 7035    Ral 7037    Ral 7042 Ral 7016    Ral 9006    Negro/Black/ Noir				
Opciones pág. 426-427 Options pages 426-427 Options pages 426-427					



Serie / Series / Série **MPB (OSLO)**

+Info: [www.infrico.com](http://www.infrico.com)

MX25PB22 H1



MX37PB22 M2

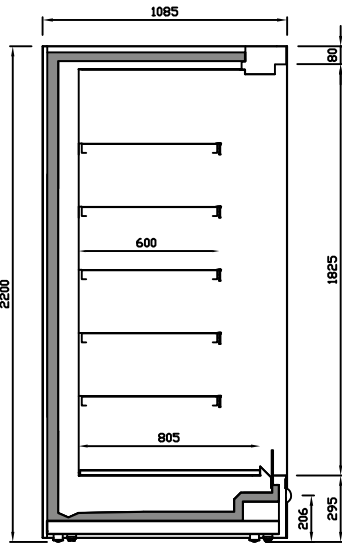

MX PB22 M2

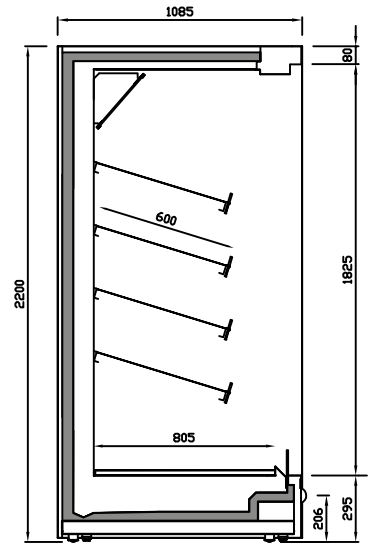

MX PB22 H1



BEBIDAS







# Mural remota de congelación cerrada

## Remote freezer full glass doors multidecks

### Murale congélation fermée groupe à distance

N: 780

MODELO MODELE MODÈLE																						
Precio Price Prix	<b>L1</b>																					
MOD.	<b>MN2P BT22 L1</b>	<b>MN3P BT22 L1</b>	<b>MN4P BT22 L1</b>	<b>MN5P BT22 L1</b>																		
Precio Price Prix	<b>L1</b>																					
Medidas / Measures / Mesures / (mm)	1562 x 780 x 2050 mm.	2343 x 780 x 2050 mm.	3124 x 780 x 2050 mm.	3905 x 780 x 2050 mm.																		
Sin costados / Without sides / Sans joues	1562 x 780 x 2200 mm. [22]	2343 x 780 x 2200 mm. [22]	3124 x 780 x 2200 mm. [22]	3905 x 780 x 2200 mm. [22]																		
T°. Prod.   Aplic. Prod. T°.   Applic. T°. (°C) Temp. Prod.   Temp. Appliq.	<b>L1: -15/-18°C   -23/-25°C</b>																					
Clase Climática Climatic class Classe climatique (°C)	3 / 25°C																					
Tensión/Frecuencia Electrical data Tension électrique	230V/1ph/50Hz																					
Controlador Controller Régulateur	Digital																					
Material Material Matériel (EXT/INT)	Acero galvanizado plastificado / Plastified galvanised steel / Acier galvanisé plastifié																					
Aislamiento Isolation Isolation (mm)	40kg/m <sup>3</sup> / Free CFC's / Zero ODP-GWP																					
Capacidad Capacity Capacité (L)	L1: 659 L1 22: 822	L1: 989 L1 22: 1233	L1: 1318 L1 22: 1844	L1: 1648 L1 22: 2055																		
Área refrigerada Refrigerated area Zone réfrigérée (x m <sup>2</sup> )	L1: 3,20 L1 22: 3,91	L1: 4,70 L1 22: 5,87	L1: 6,30 L1 22: 7,83	L1: 7,90 L1 22: 9,78																		
Niveles Exposición Exposition Levels Niveaux d'exposition	L1: 4+Expos. L1 22: 5+Expos.																					
Costados [2] Sides [2] Joues [2] (mm)	60 + 60																					
Puertas Doors Portes	2	3	4	5																		
Sistema de frío Cooling System Système de froid	Ventilado / Ventilated / Ventilé																					
Desescarche Defrost Dégivrage	Automático / Automatic / Automatique																					
Evaporación Evaporation Évaporation	Forzada / Forced / Ventilé																					
Potencia Power Puissance (W)	-																					
Potencia frig. Cooling capacity Puissance Frig. (W A -10°C)	L1: 1207 L1 22: 1298	L1: 1809 L1 22: 1947	L1: 2412 L1 22: 2596	L1: 3015 L1 22: 3245																		
Consumo Consumption Consommation (kWh/ 24h)	-																					
Refrigerante Refrigerant Gaz	<b>FREON</b>																					
Colores estándar Standar colors Couleurs standard	<b>Int. Estándar / Standar / Standard</b> <table border="1"> <tr> <td>Blanco/White/ Blanc</td> <td>Negro/Black/ Noir</td> </tr> </table>		Blanco/White/ Blanc	Negro/Black/ Noir	<b>Laterales / Sides / Joues</b> <b>No Incluidos / Not includes / Non inclus</b>																	
Blanco/White/ Blanc	Negro/Black/ Noir																					
Laterales disponibles Available sides Joues disponibles	<b>Ext. Estándar / Standar / Standard</b> <table border="1"> <tr> <td>Blanco/White/ Blanc</td> <td>Ral 1015</td> <td>Ral 1018</td> </tr> <tr> <td>Ral 2003</td> <td>Ral 3003</td> <td>Ral 3020</td> </tr> <tr> <td>Ral 5015</td> <td>Ral 5017</td> <td>Ral 5011</td> </tr> <tr> <td>Ral 6002</td> <td>Ral 6018</td> <td>Ral 6019</td> </tr> <tr> <td>Ral 7035</td> <td>Ral 7037</td> <td>Ral 7042</td> </tr> <tr> <td>Ral 7016</td> <td>Ral 9006</td> <td>Negro/Black/ Noir</td> </tr> </table>		Blanco/White/ Blanc	Ral 1015	Ral 1018	Ral 2003	Ral 3003	Ral 3020	Ral 5015	Ral 5017	Ral 5011	Ral 6002	Ral 6018	Ral 6019	Ral 7035	Ral 7037	Ral 7042	Ral 7016	Ral 9006	Negro/Black/ Noir	 <b>Lateral Espejo</b> <b>Mirror end panels</b> <b>Joue Miroir</b>	
Blanco/White/ Blanc	Ral 1015	Ral 1018																				
Ral 2003	Ral 3003	Ral 3020																				
Ral 5015	Ral 5017	Ral 5011																				
Ral 6002	Ral 6018	Ral 6019																				
Ral 7035	Ral 7037	Ral 7042																				
Ral 7016	Ral 9006	Negro/Black/ Noir																				
Opciones pág. 426-427 Options pages 426-427 Options pages 426-427																						

10

Serie / Series / Série **MBT (TORONTO)**

+Info: [www.infrico.com](http://www.infrico.com)

MN5P BT22 L1



MN5P BT L1

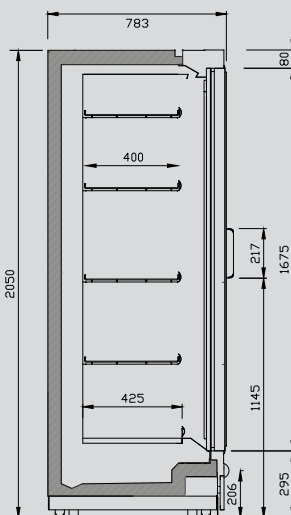

MN BT L1

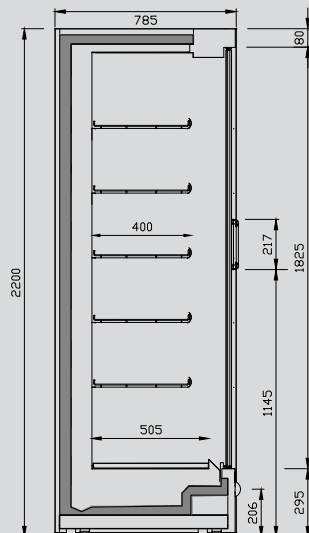

MN BT22 L1



Los datos técnicos están sujetos a posibles variaciones que serán actualizadas periódicamente en las fichas técnicas del producto, disponibles en el sitio web.  
The technical data are subject to possible variations that will be updated periodically in the technical data sheets of the product, which are available on the website.  
Les données techniques peuvent varier et seront actualisées dans les fiches techniques du produit, disponibles sur le site web.

# Mural remota de congelación cerrada

## Remote freezer full glass doors multidecks

### Murale congélation fermée groupe à distance



MODELO MODELE MODÈLE																						
<b>Precio</b> Price Prix	<b>L1</b>																					
<b>MOD.</b>	<b>MF2P BT22 L1</b>	<b>MF3P BT22 L1</b>	<b>MF4P BT22 L1</b>	<b>MF5P BT22 L1</b>																		
<b>Precio</b> Price Prix	<b>L1</b>																					
<b>Medidas / Measures / Mesures</b> (mm)	1562 x 980 x 2050 mm.	2343 x 980 x 2050 mm.	3124 x 980 x 2050 mm.	3905 x 980 x 2050 mm.																		
<b>Sin costados / Without sides / Sans joues</b>	1562 x 980 x 2200 mm. [22]	2343 x 980 x 2200 mm. [22]	3124 x 980 x 2200 mm. [22]	3905 x 980 x 2200 mm. [22]																		
<b>T°. Prod.   Aplic.</b> Prod. T°.   Applic. T°. (°C) Temp. Prod.   Temp. Appliq.	<b>L1: -15/-18°C   -23/-25°C</b>																					
<b>Clase Climática</b> Climatic class Classe climatique (°C)	3 / 25°C																					
<b>Tensión/Frecuencia</b> Electrical data Tension électrique	230V/1ph/50Hz																					
<b>Controlador</b> Controller Régulateur	Digital																					
<b>Material</b> Material Matériel (EXT/INT)	Acero galvanizado plastificado / Plastified galvanised steel / Acier galvanisé plastifié																					
<b>Aislamiento</b> Isolation Isolation (mm)	40kg/m <sup>3</sup> / Free CFC's / Zero ODP-GWP																					
<b>Capacidad</b> Capacity Capacité (L)	L1: 1232 L1 22: 1466	L1: 1845 L1 22: 2197	L1: 2460 L1 22: 2929	L1: 3075 L1 22: 3661																		
<b>Área refrigerada</b> Refrigerated area Zone réfrigérée (x m <sup>2</sup> )	L1: 4,7 L1 22: 5,7	L1: 7,1 L1 22: 8,5	L1: 9,45 L1 22: 11,3	L1: 11,8 L1 22: 14,2																		
<b>Niveles Exposición</b> Exposition Levels Niveaux d'exposition	L1: 4+Expos. L1 22: 5+Expos.																					
<b>Costados [2]</b> Sides [2] Joues [2] (mm)	60 + 60																					
<b>Puertas</b> Doors Portes	2	3	4	5																		
<b>Sistema de frío</b> Cooling System Système de froid	Ventilado / Ventilated / Ventilé																					
<b>Desescarche</b> Defrost Dégivrage	Automático / Automatic / Automatique																					
<b>Evaporación</b> Evaporation Évaporation	Forzada / Forced / Ventilé																					
<b>Potencia</b> Power Puissance (W)	-																					
<b>Potencia frig.</b> Cooling capacity Puissance Frig. (W A -10°C)	L1: 1245 L1 22: 1336	L1: 1865 L1 22: 2001	L1: 2487 L1 22: 2668	L1: 3108 L1 22: 3335																		
<b>Consumo</b> Consumption Consommation (kWh/ 24h)	-																					
<b>Refrigerante</b> Refrigerant Gaz	<b>FREON</b>																					
<b>Colores estándar</b> Standar colors Couleurs standard	<b>Int. Estándar / Standar / Standard</b> <table border="1"> <tr> <td>Blanco/White/ Blanc</td> <td>Negro/Black/ Noir</td> </tr> </table>		Blanco/White/ Blanc	Negro/Black/ Noir	<b>Laterales / Sides / Joues</b> <b>No Incluidos / Not includes / Non inclus</b>																	
Blanco/White/ Blanc	Negro/Black/ Noir																					
<b>Laterales disponibles</b> Available sides Joues disponibles	<b>Ext. Estándar / Standar / Standard</b> <table border="1"> <tr> <td>Blanco/White/ Blanc</td> <td>Ral 1015</td> <td>Ral 1018</td> </tr> <tr> <td>Ral 2003</td> <td>Ral 3003</td> <td>Ral 3020</td> </tr> <tr> <td>Ral 5015</td> <td>Ral 5017</td> <td>Ral 5011</td> </tr> <tr> <td>Ral 6002</td> <td>Ral 6018</td> <td>Ral 6019</td> </tr> <tr> <td>Ral 7035</td> <td>Ral 7037</td> <td>Ral 7042</td> </tr> <tr> <td>Ral 7016</td> <td>Ral 9006</td> <td>Negro/Black/ Noir</td> </tr> </table>		Blanco/White/ Blanc	Ral 1015	Ral 1018	Ral 2003	Ral 3003	Ral 3020	Ral 5015	Ral 5017	Ral 5011	Ral 6002	Ral 6018	Ral 6019	Ral 7035	Ral 7037	Ral 7042	Ral 7016	Ral 9006	Negro/Black/ Noir	<p>Lateral Espejo Mirror end panels Joue Miroir</p>	<p>Lateral Display Display end panels Joue Display</p>
Blanco/White/ Blanc	Ral 1015	Ral 1018																				
Ral 2003	Ral 3003	Ral 3020																				
Ral 5015	Ral 5017	Ral 5011																				
Ral 6002	Ral 6018	Ral 6019																				
Ral 7035	Ral 7037	Ral 7042																				
Ral 7016	Ral 9006	Negro/Black/ Noir																				
<b>Opciones pág. 426-427</b> Options pages 426-427 Options pages 426-427																						

Serie / Series / Série **MBT (TORONTO)**

+Info: [www.infrico.com](http://www.infrico.com)

MF5P BT L1



MF5P BT22 L1

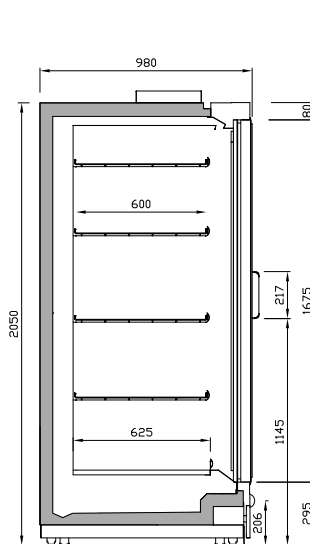

MF BT L1

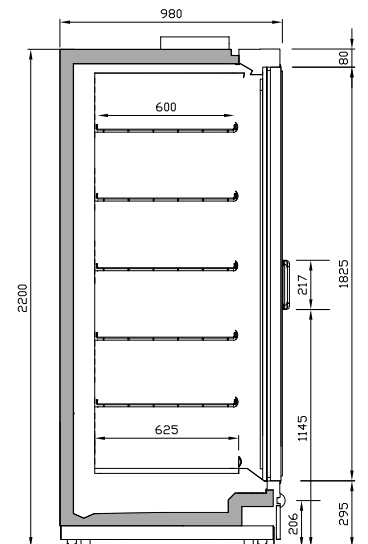

MF BT22 L1



# Mural mixta de congelación cerrada

## Mixed freezer full glass doors multidecks

### Murale mixte congélation fermée

N: 780



MODELO  
MODELE  
MODÈLE

MN2P BTU L1

MN3P BTU L1

<b>Precio</b> Price Prix	<b>L1</b>																					
<b>Medidas / Measures /</b> Mesures / [mm] <b>Sin costados / Without</b> sides / Sans joues	1562 x 780 x 2050 mm.	2343 x 780 x 2050 mm.																				
<b>T°. Prod.   Aplic.</b> Prod. T°.   Applic. T°. [°C] Temp. Prod.   Temp. Appliq.	<b>L1: -15/-18°C   -23/-25°C</b>																					
<b>Clase Climática</b> Climatic class Classe climatique [°C]	3 / 25°C																					
<b>Tensión/Frecuencia</b> Electrical data Tension électrique	230V/1ph/50Hz																					
<b>Controlador</b> Controller Régulateur	Digital																					
<b>Material</b> Material Matériel [EXT/INT]	Acero galvanizado plastificado / Plastified galvanised steel / Acier galvanisé plastifié																					
<b>Aislamiento</b> Isolation Isolation [mm]	40kg/m <sup>3</sup> / Free CFC's / Zero ODP-GWP																					
<b>Capacidad</b> Capacity Capacité [L]	L1: 648	L1: 973																				
<b>Área refrigerada</b> Refrigerated area Zone réfrigérée [x m <sup>2</sup> ]	L1: 3,16	L1: 4,70																				
<b>Niveles Exposición</b> Exposition Levels Niveaux d'exposition	L1: 4+Expos.																					
<b>Costados [2]</b> Sides [2] Joues [2] [mm]	60 + 60																					
<b>Puertas</b> Doors Portes	2	3																				
<b>Sistema de frío</b> Cooling System Système de froid	Ventilado / Ventilated / Ventilé																					
<b>Desescarche</b> Defrost Dégivrage	Automático / Automatic / Automatique																					
<b>Evaporación</b> Evaporation Evaporation	Forzada / Forced / Ventilé																					
<b>Potencia</b> Power Puissance [W]	2043	3058																				
<b>Potencia frig.</b> Cooling capacity Puissance Frig. [W A -10°C]	-	-																				
<b>Consumo</b> Consumption Consommation [kWh/ 24h]	29,4	40,4																				
<b>Refrigerante</b> Refrigerant Gaz	<b>R-290</b>																					
<b>Colores estándar</b> Standard colors Couleurs standard	<p><b>Int. Estándar / Standar / Standard</b></p> <table border="1"> <tr> <td>Blanco/White/ Blanc</td> <td>Negro/Black/ Noir</td> </tr> </table> <p><b>Ext. Estándar / Standar / Standard</b></p> <table border="1"> <tr> <td>Blanco/White/ Blanc</td> <td>Ral 1015</td> <td>Ral 1018</td> </tr> <tr> <td>Ral 2003</td> <td>Ral 3003</td> <td>Ral 3020</td> </tr> <tr> <td>Ral 5015</td> <td>Ral 5017</td> <td>Ral 5011</td> </tr> <tr> <td>Ral 6002</td> <td>Ral 6018</td> <td>Ral 6019</td> </tr> <tr> <td>Ral 7035</td> <td>Ral 7037</td> <td>Ral 7042</td> </tr> <tr> <td>Ral 7016</td> <td>Ral 9006</td> <td>Negro/Black/ Noir</td> </tr> </table>		Blanco/White/ Blanc	Negro/Black/ Noir	Blanco/White/ Blanc	Ral 1015	Ral 1018	Ral 2003	Ral 3003	Ral 3020	Ral 5015	Ral 5017	Ral 5011	Ral 6002	Ral 6018	Ral 6019	Ral 7035	Ral 7037	Ral 7042	Ral 7016	Ral 9006	Negro/Black/ Noir
Blanco/White/ Blanc	Negro/Black/ Noir																					
Blanco/White/ Blanc	Ral 1015	Ral 1018																				
Ral 2003	Ral 3003	Ral 3020																				
Ral 5015	Ral 5017	Ral 5011																				
Ral 6002	Ral 6018	Ral 6019																				
Ral 7035	Ral 7037	Ral 7042																				
Ral 7016	Ral 9006	Negro/Black/ Noir																				
<b>Laterales disponibles</b> Available sides Joues disponibles	<p><b>Laterales / Sides / Joues</b></p> <p>No Incluidos / Not includes / Non inclus</p>  <p>Lateral Espejo Mirror end panels Joue Miroir</p>																					
<b>Opciones pág. 426-427</b> Options pages 426-427 Options pages 426-427																						

10

Serie / Series / Série **MBTU (MONTREAL)**

+Info: [www.infrico.com](http://www.infrico.com)

MN3P BTU L1



Estantes profundidad 400mm  
Shelves 400mm depth  
Profondeur des étagères 400mm



**Nuevo paragolpes frontal**

**New front bumper**

**Nouveau pare-chocs frontale**

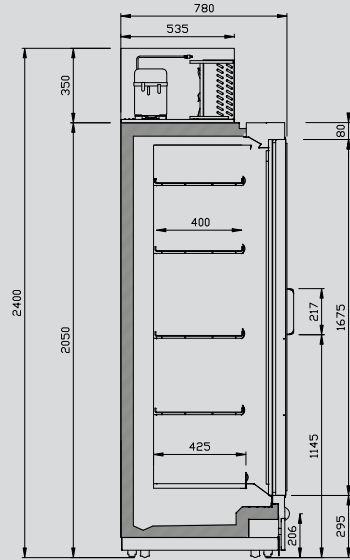





# Mural plug in de congelación cerradas

## Plug in freezer full glass doors multidecks

### Murale de congélation fermée groupe incorporé

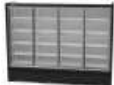
N: 780

MODELO MODELE MODÈLE																					
<b>Precio</b> Price Prix	<b>L1</b>																				
<b>MOD.</b>	<b>MN12 BTPC L1</b>	<b>MN18 BTPC L1</b>	<b>MN25 BTPC L1</b>																		
<b>Precio</b> Price Prix	<b>C L1</b>																				
<b>Medidas</b> Measures [mm] Mesures	1250 x 780 x 2000 mm.	1835 x 780 x 2000 mm.	2500 x 780 x 2000 mm.																		
<b>T°. Prod.   Aplic.</b> Prod. T°.   Applic. T°. [°C] Temp. Prod.   Temp. Appliq.	<b>L1: -15/-18°C   -23/-25°C</b>																				
<b>Clase Climática</b> Climatic class Classe climatique [°C]	3 / 25°C																				
<b>Tensión/Frecuencia</b> Electrical data Tension électrique	230V/1ph/50Hz																				
<b>Controlador</b> Controller Régulateur	Digital																				
<b>Material</b> Material [EXT/INT] Matériel	Acero galvanizado plastificado / Plastified galvanised steel / Acier galvanisé plastifié																				
<b>Aislamiento</b> Isolation [mm] Isolation	40kg/m <sup>3</sup> / Free CFC's / Zero ODP-GWP																				
<b>Capacidad</b> Capacity [L] Capacité	664	996	1328																		
<b>Área refrigerada</b> Refrigerated area [x m <sup>2</sup> ] Zone réfrigérée	2,54	3,81	5,08																		
<b>Niveles Exposición</b> Exposition Levels Niveaux d'exposition	4+Expos.																				
<b>Costados [2]</b> Sides [2] Joues [2] [mm]	60 + 60																				
<b>Puertas</b> Doors Portes	2	3	4																		
<b>Sistema de frío</b> Cooling System Système de froid	Ventilado / Ventilated / Ventilé																				
<b>Desescarche</b> Defrost Dégivrage	Automático / Automatic / Automatique																				
<b>Evaporación</b> Evaporation Évaporation	Forzada / Forced / Ventilé																				
<b>Potencia</b> Power [W] Puissance	1282	1695	2512																		
<b>Potencia frig.</b> Cooling capacity [W A -10°C] Puissance Frig.	-	-	-																		
<b>Consumo</b> Consumption [kWh/ 24h] Consommation	23,1	30,5	45,2																		
<b>Refrigerante</b> Refrigerant Gaz	<b>R-290</b>																				
<b>Colores estándar</b> Standar colors Couleurs standard	<p><b>Int. Estándar / Standar / Standard</b></p> <table border="1"> <tr> <td>Blanco/White/ Blanc</td> <td>Negro/Black/ Noir</td> </tr> </table>			Blanco/White/ Blanc	Negro/Black/ Noir																
Blanco/White/ Blanc	Negro/Black/ Noir																				
<b>Laterales disponibles</b> Available sides Joues disponibles	<p><b>Ext. Estándar / Standar / Standard</b></p> <table border="1"> <tr> <td>Blanco/White/ Blanc</td> <td>Ral 1015</td> <td>Ral 1018</td> </tr> <tr> <td>Ral 2003</td> <td>Ral 3003</td> <td>Ral 3020</td> </tr> <tr> <td>Ral 5015</td> <td>Ral 5017</td> <td>Ral 5011</td> </tr> <tr> <td>Ral 6002</td> <td>Ral 6018</td> <td>Ral 6019</td> </tr> <tr> <td>Ral 7035</td> <td>Ral 7037</td> <td>Ral 7042</td> </tr> <tr> <td>Ral 7016</td> <td>Ral 9006</td> <td>Negro/Black/ Noir</td> </tr> </table>			Blanco/White/ Blanc	Ral 1015	Ral 1018	Ral 2003	Ral 3003	Ral 3020	Ral 5015	Ral 5017	Ral 5011	Ral 6002	Ral 6018	Ral 6019	Ral 7035	Ral 7037	Ral 7042	Ral 7016	Ral 9006	Negro/Black/ Noir
Blanco/White/ Blanc	Ral 1015	Ral 1018																			
Ral 2003	Ral 3003	Ral 3020																			
Ral 5015	Ral 5017	Ral 5011																			
Ral 6002	Ral 6018	Ral 6019																			
Ral 7035	Ral 7037	Ral 7042																			
Ral 7016	Ral 9006	Negro/Black/ Noir																			
<b>Opciones pág. 426-427</b> Options pages 426-427 Options pages 426-427	<p><b>Laterales / Sides / Joues</b></p> <p>No Incluidos / Not includes / Non inclus</p> <div style="display: flex; justify-content: space-around;"> <div style="text-align: center;">  <p>Lateral Espejo Mirror end panels Joue Miroir</p> </div> <div style="text-align: center;">  <p>Lateral Display Display end panels Joue Display</p> </div> </div>																				

10



Serie / Series / Série **MBTP (VANCOUVER)**

+Info: [www.infrico.com](http://www.infrico.com)

MN25 BTP L1



Estantes profundidad 400mm  
Shelves 400mm depth  
Profondeur des étagères 400mm



**Nuevo  
paragolpes  
frontal**

**New  
front  
bumper**

**Nouveau  
pare-chocs  
frontale**



MN12 BTP L1



MN18 BTP L1

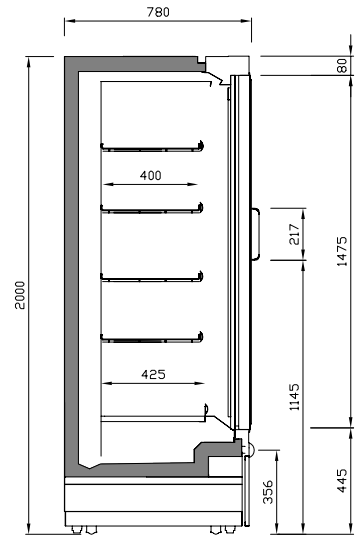

MN BTP L1



## Opciones / Options / Options

### Colores fuera de carta (epoxi) x mueble / non-standard colours (epoxy) per unit / couleurs hors palette (epoxi) x meuble

Exterior / Exterior / Extérieure	
Interior RAL Infrico Supermarket excepto blanco, negro y gris antracita [7016] / RAL Infrico Supermarket interior except black, white and anthracite grey [7016] / Intérieure RAL Infrico Supermarket sauf noir, blanc et gris anthracite [7016]	

### Semimurales grupo incorporado / Plug In low multidecks / Semi murales groupe Incorporé

General General Général	Led cornisa RT Led canopy RT Led corniche RT [carne / meat / viande]	Led estante (línea) Shelf led (line) Led étagère (ligne) 4000k/2700K	Led estante RT carne Shelf led RT meat Led étagère RT viande [línea / line / ligne]	Lateral espejo Mirror end wall Joue miroir	Lateral display Display end wall Joue display	Frente estante metacr. Methacr. shelf front Étagère frontale méthac.
SMS/SML6						
SMS/SML9						
SMS/SML12						
SMS/SML18						
SMS/SML25						

### Semimurales grupo remoto / Remote group low multidecks / Semi murales groupe à distance

General General Général	Led cornisa RT Led canopy RT Led corniche RT [carne / meat / viande]	Led estante (línea) Shelf led (line) Led étagère (ligne) 4000k/2700K	Led estante RT carne Shelf led RT meat Led étagère RT viande [línea / line / ligne]
SML12			
SML18			
SML25			
SML37			

General General Général	Lateral espejo Mirror side end Joue miroir	Lateral panorámico Panoramic side end Joue panoramique	Lateral display Display side end Joue display	Frente estante metacrilato Methacrylate shelf front Étagère frontale méthacrylate
SML12				
SML18				
SML25				
SML37				

### Murales grupo incorporado / Plug In multidecks / Murales groupe incorporé

General General Général	Lateral espejo Mirror side end Joue miroir	Lateral espejo Inox Mirror side end Inox Joue miroir Inox	Lateral display Display end wall Joue display	Lateral display Inox Display side end Inox Joue display Inox	Separador central espejo Central mirror divider Séparateur central miroir
MS					
MN					
ML					

General General Général	SCC Sist. Condens. Cristal SCC Condens. glass system SCC Syst. condens. vitre	Frente estante metacrilato Methacrylate shelf front Étagère frontale méthacrylate	MS Línea estante 300 MS Shelf line 300 Ligne étagère MS 300	MN/ML Línea estante 400 MN/ML Shelf line 400 Ligne étagère MN/ML 400
MS/MN/ML6				
MS/MN/ML9				
MS/MN/ML12				
MS/MN/ML18				
MS/MN/ML25				

Iluminación Lighting Éclairage	Led cornisa RT Led canopy RT Led corniche RT [carne / meat / viande]	Led estante (línea) Shelf led (line) Led étagère (ligne) 4000k/2700K	Led estante RT carne Shelf led RT meat Led étagère RT viande [línea / line / ligne]	Led vertical 4000K Vertical led 4000K Led vertical 4000K	Led vertical 2700K Vertical led 2700K Led vertical 2700K	Led vertical RT Vertical led RT Led vertical RT [carne / meat / viande]
MS/MN/ML6						
MS/MN/ML9						
MS/MN/ML12						
MS/MN/ML18						
MS/MN/ML25						

**Murales grupo remoto / Remote multidecks / Murales groupe remote**

Lateral/Separador Side end/ Divider Joues/Séparateur	Lateral panorámico Panoramic side end Joue panoramique	Lateral Display Display side end Joue Display	Lateral espejo Mirror side end Joue miroir	Separador central Central divider Séparateur central	Separador fijo metacrilato Methacrylate fixed divider Séparateur fixe méthacrylate	
MS						
MN						
MN22						
ML						
ML22						
MX						
MX22						
<b>General</b> General Général	<b>Kit espejo</b> Mirror kit Kit miroir	<b>Línea estante 400</b> Shelf line 400 Étagère 400	<b>Línea estante 450</b> Shelf line 450 Ligne étagère 450	<b>Línea estante 500</b> Shelf line 500 Ligne étagère 500	<b>Línea estante 600</b> Shelf line 600 Ligne étagère 600	
MS/MN/ML/MX9						
MS/MN/ML/MX12						
MS/MN/ML/MX18						
MS/MN/ML/MX25						
MS/MN/ML/MX31						
MS/MN/ML/MX37						
<b>General</b> General Général	<b>SCC Sist. Condens. Cristal</b> SCC Condens. glass system SCC Syst. condens. vitre	<b>Frente estante metacrilato</b> Methacrylate shelf front Étagère frontale méthacrylate	<b>Ventiladores elect.</b> Electronic fan Ventilateurs élect.	<b>Control elect.</b> Electronic control Control élect.	<b>Termómetro</b> Thermometer Thermomètre	<b>Salida tubos sup.</b> Top tube output Sortie tube sup.
MS/MN/ML/MX9				de serie	de serie	de serie
MS/MN/ML/MX12				de serie	de serie	de serie
MS/MN/ML/MX18				de serie	de serie	de serie
MS/MN/ML/MX25				de serie	de serie	de serie
MS/MN/ML/MX31				de serie	de serie	de serie
MS/MN/ML/MX37				de serie	de serie	de serie
<b>Iluminación</b> Lighting Éclairage	<b>Led cornisa RT</b> Led canopy RT Led corniche RT (carne / meat / viande)	<b>Led estante (línea)</b> Shelf led (line) Led étagère (ligne) 4000k/2700K	<b>Led estante RT carne</b> Shelf led RT meat Led étagère RT viande (línea / line / ligne)	<b>Led vertical 4000K</b> Vertical led 4000K Led vertical 4000K	<b>Led vertical 2700K</b> Vertical led 2700K Led vertical 2700K	<b>Led vertical RT</b> Vertical led RT Led vertical RT (carne / meat / viande)
MS/MN/ML/MX9						
MS/MN/ML/MX12						
MS/MN/ML/MX18						
MS/MN/ML/MX25						
MS/MN/ML/MX31						
MS/MN/ML/MX37						

**Murales Congelación grupo incorp. MBTP / Plug In freezer multidecks MBTP / Murales congélation groupe inc. MBTP**

Lateral Display Display side end Joue Display	Lateral Opaco Opaque side end Joue opaque	Separador central Central divider Séparateur central	Separador fijo metacrilato Methacrylate fixed divider Séparateur fixe méthacrylate
MNBTP			

**Murales Congelación grupo remoto MBT-MBTU / Freezer multidecks MBT-MBTU / Murales congélation groupe à dist. MBT-MBTU**

Lateral Opaco Opaque side end Joue Opaque	Lateral Display Display side end Joue Display	Separador fijo metacrilato Methacrylate fixed divider Séparateur fixe méthacrylate	Ventiladores alta efic. 1 x puerta High efficiency fans 1 x door Ventilateurs haut rendem. 1 x porte	Separador central Central divider Séparateur central	Voltajes especiales Special voltages Tension élect. spéciale
MN					
MN22					
MF					
MF22					
					Consultar/ Consult/ Consulter

**Válvula termostática / Thermostatic valve / Vanne thermostatique**

R404a	R410a	R513a	Electrónica Electronic Electronique
R507a	R134a	R449a	



## Unidades motocondensadoras Condensing units Motocondensateurs

## Serie / Series / Série **SIGILUS** / **INTARBOX**

### SIGILUS

Unidades motocondensadoras compactas en construcción silenciosa y motoventilador axial.

Refrigerante R449 A o R134a, o refrigerantes alternativos.

Compresor hermético alternativo, montado sobre amortiguadores, con silenciador de descarga, resistencia de cárter y clixon interno.

Batería condensadora de amplia superficie, de tubos de cobre y aletas de aluminio, con dimensionamiento tropicalizado para temperatura ambiente de hasta 50 °C.

Motoventilador axial de bajas revoluciones.

Control proporcional de presión de condensación mediante variación de velocidad del motoventilador.

Circuito frigorífico equipado con presostatos de alta y baja presión, filtro cerámico, recipiente y visor de líquido.

Air-cooled packaged condensing units in a low-noise axial construction in mechanical, and multiservice versions.

R134a or R449A refrigerant or alternative refrigerants.

Reciprocating hermetic or scroll compressor, acoustically insulated, with discharge muffler, mounted on shock absorbers, with internal klixon and crankcase heater.

Large surface condenser coil, copper pipes and aluminum fins, tropicalised for ambient temperature up to 50 °C.

Low rpm motor fans, mounted on nozzles dynamically balanced propellers and external protection grilles.

Variable speed axial fan for proportional condensation pressure control.

Refrigeration circuit equipped with high and low pressure switches, ceramic filter and sight gauge.

Unité de condensation silencieuse et motoventilateur.

Gaz réfrigérant R449, R134a.

Compresseur hermétique alternatif, monté sur amortisseurs, silencieux de refoulement, résistance de carter et klixon interne.

Batterie de condensation de grande surface d'échange de tubes de cuivre et ailettes en aluminium avec dimensionnement tropicalisé pour température ambiante jusqu'à 50°C.

Motoventilateur à basse vitesse.

Contrôle modulant de la pression de condensation par variation de la vitesse du motoventilateur.

Circuit frigorifique équipé avec pressostats de haute et basse pression, filtre céramique, récipient et viseur de liquide.

### INTARBOX

Unidades motocondensadoras compactas en construcción horizontal y motoventilador axial o centrífugo.

Refrigerante R449 A o R134a, o refrigerantes alternativos.

Compresor hermético alternativo, montado sobre amortiguadores, con silenciador de descarga y clixon interno.

Batería condensadora de tubos de cobre y aletas de aluminio.

Turbina centrífuga con presión estática disponible para la conducción del aire de condensación (versión centrífuga).

Circuito frigorífico equipado con presostatos de alta y baja presión, filtro cerámico, recipiente y visor de líquido.

Control digital de presión de condensación en versiones -N, y control de condensación todo-nada en versiones -M.

Control proporcional de presión de condensación mediante variación de velocidad del motoventilador (incluido a partir de MDH serie 4 y 5).

Cuadro eléctrico de potencia y maniobra, con protección de compresor y motoventilador.

Air-cooled packaged condensing units with axial or centrifugal fan.

R134a or R449A refrigerant or alternative refrigerants.

Hermetic reciprocating compressor mounted on shock absorbers, with discharge muffler and internal klixon.

High performance condensing coil in copper pipes and aluminium fins.

Centrifugal motor fan with available static pressure for a ducted outlet of condenser hot air (centrifugal version).

Refrigeration circuit equipped with HP and LP switches, filter dryer, liquid receiver and sight gauge.

Digital control of condensing pressure (version N) and on/off control of condensing pressure (version M).

Proportional control of condensing pressure through fan speed variation (version N series 4 and 5).

Full control and power board with compressor and motor fan protection.

Unités moto-condenseurs et motoventilateur centrifuge.

Réfrigérant R449, R134a ou réfrigérants alternatifs.

Compresseur hermétique alternatif, monté sur amortisseurs, silencieux de refoulement et klixon interne.

Batterie de condensation à tubes de cuivre et d'ailettes en aluminium.

Motoventilateur centrifuge avec pression statique disponible pour le gainage de l'air de condensation.

Circuit frigorifique équipé de pressostats d'haute et basse pression filtre céramique, bouteille et voyant de liquide.

Contrôle digital de la pression de condensation en version -N et contrôle de la pression de condensation tout-rien -M.

Contrôle proportionnel de la pression de condensation par variation de vitesse du motoventilateur (à partir de MDH séries 4).

Cadre électrique de puissance et manœuvre avec protection de compresseur et motoventilateur.



# Unidades multiservicio con sistema VRC

## Multiservice units VRC system

### Version multiservice avec système VRC

+Info: [www.infrico.com](http://www.infrico.com)

#### Estructura

Válvula presostática de aspiración [VP].  
 Válvula presostática de by-pass [VC].  
 Válvula termostática de inyección de líquido [VE].  
 Presostato de control [IP].  
 Separador de aceite.

El sistema VRC aplicado a un compresor hermético alternativo adapta el flujo de refrigerante a la demanda de las unidades evaporadoras manteniendo constante la presión en la línea de aspiración.

El sistema VRC se compone de un juego de válvulas de regulación de presión y temperatura capaces de variar de forma progresiva la capacidad frigorífica de un compresor entre un 100% y un 10% de su potencia nominal, a la vez que se reduce la potencia eléctrica absorbida y se protege el compresor al mantener su relación de compresión dentro de los márgenes de seguridad, evitando el riesgo de sobrecalentamiento.

Versión horizontal centrífuga o axial multiservicio Intarbox-multi: series MDH-CV/-V.  
 Versión horizontal axial silenciosa multiservicio Siligus-multi: series MDF-V.

#### Estructure

Suction pressure valve [VP].  
 By-pass pressure valve [VC].  
 Thermostatic expansion valve for liquid injection [VE].  
 Pressure control switch [IP].  
 Oil separator.

The VRC system applied to a reciprocating hermetic compressor adjusts the flow of refrigerant to the evaporator unit's demand by maintaining constant pressure in the suction line.

The VRC system is composed of a set of pressure and temperature valves capable of progressive variation of a compressor's cooling capacity between 100% and 10% of this rated power, at the same time the system reduces electrical input power and protects the compressor, maintaining its compression ratio within security margins, eliminating the risk of overheating.  
 Intarbox horizontal axial or centrifugal for several services Series MDH-CV/-V.  
 Sigilus low-noise axial for several services.

#### Structure

Vanne pressostatique d'aspiration [VP].  
 Vanne pressostatique de by-pass [VC].  
 Détendeur thermostatique d'injection de liquide [VE].  
 Pressostat de contrôle [IP].  
 Séparateur d'huile.

Le système VRC à un seul compresseur hermétique à piston adapte le flux du gaz à la demande des unités d'évaporation, en maintenant de manière constante la pression de la ligne d'aspiration.

Le système VRC est constitué par un ensemble de vannes de régulation de pression et de température qui peuvent varier progressivement la capacité frigorifique du compresseur de 100% jusqu'à 10% de sa puissance nominale, tout en réduisant la puissance électrique absorbée et en protection du compresseur par maintenir son fonctionnement dans les marges de sécurité afin d'éviter le risque de surchauffage.

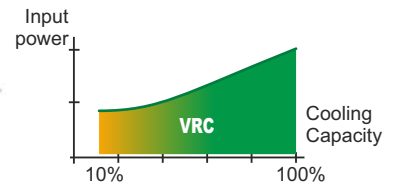
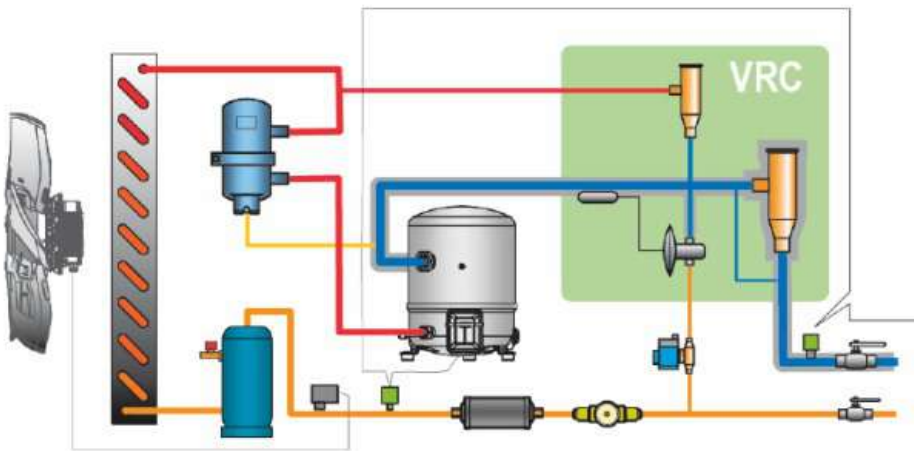

#### Ejemplo instalación multiservicio

#### Multiservice installation

#### Exemple d'installation multiservice

Los equipos en versión multiservicio están diseñados para centralizar la producción frigorífica de un conjunto de unidades evaporadoras.

Multi-service condensing units are specifically designed for cooling production centralization of a set of positive or negative temperature evaporating units.

Les unités motocondensateurs à système VRC, permettent de centraliser la production frigorifique d'un ensemble de services, en maintenant de manière constante la pression et température du gaz dans les évaporateurs.

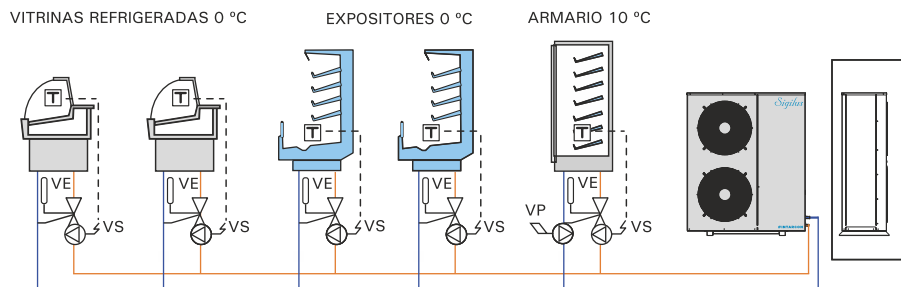

T: TERMOSTATO  
 VE: VÁLVULA DE EXPANSIÓN  
 VS: VÁLVULA SOLENOIDE  
 VP: VÁLVULA DE PRESIÓN CONSTANTE

# Motocondensadoras Condensing units Motocondensateurs

### Opciones / Options / Options

Cambio a alimentación 400 V-III-50 Hz	Precio Price (€) Prix
Separador de aceite [ya incluido en versiones -V]	
Válvula solenoide integrada con cuerpo y bobina [sólo en versiones -N y -M]	
Recubrimiento anticorrosión de batería	
Rejilla exterior de protección de batería	
Control de condensación proporcional por variación de velocidad del motoventilador [Serie 1 monofásicos]	
Versión electrónica	



### 230 V-I-50 Hz / 400 V-III-50 Hz | R134a - R449A | Media temperatura 1 o 2 servicios /

REFRIGERANTE	SERIE / MODELO SERIES / MODEL SÉRIES / MODÈLE	COMPRESOR COMPRESSOR COMPRESSEUR		POTENCIA FRIGORÍF. POWER PUISSANCE FRIGORIF. EN13215 (W) <sup>(1)</sup> T° EVAP. -35 °C	POT. FRIGOR./POWER/PUISSANCE FRIGORIF. (W) <sup>(2)</sup> TEMP. EVAPORAC./EVAPORATION TEMP./TEMP. D'ÉVAPOR.				POTEN. ABSOR. NOMINAL NOMINAL POW. ABSOR. PUISS. ABSORC. NOMINALE (kW)	[C.O.P.] S.E.P.R. <sup>(3)</sup>	INTENS. MÁX. ABSORCIÓN MAX. ABSOR. POWER INTENS. MAX. ABSOR. (A)	VENTILADOR FAN VENTILATEUR Ø mm	CAUDAL FLOW RATE DÉBIT D'AIR (m³/h)	CONEXIÓN FRIGORÍFICA COOLING CONNECTION CONNECTION FRIGORIFIQUE LIQ - GAS	PESO WEIGHT POIDS (kg)	NIVEL PRES. SONORA SOUND PRESS. LEVEL NIVEAU PRESS. SONORE dB(A) <sup>(6)</sup>	PVP PRICE PVP (€)
		CV	TENSIÓN	0 °C	-5 °C	-10 °C	-15 °C	INTENS. MÁX. ABSORCIÓN MAX. ABSOR. POWER INTENS. MAX. ABSOR. (A)	Ø mm	(m³/h)	LIQ - GAS	(kg)	NIVEL PRES. SONORA SOUND PRESS. LEVEL NIVEAU PRESS. SONORE dB(A) <sup>(6)</sup>	PVP PRICE PVP (€)			
R134a	MDF-MY-0 010	3/8	230 V-I	570	880	710	560	430	0,33	[1,75]	4	0 200	350	1/4"-3/8"	50	28	
	MDF-MY-0 015	1/2	230 V-I	795	1 200	975	775	595	0,46	[1,73]	5	0 200	350	1/4"-3/8"	52	29	
	MDF-MY-1 015	1/2	230 V-I	875	1 395	1 110	865	650	0,49	[1,78]	5	0 360	1 700	1/4"-1/2"	66	31	
	MDF-MY-1 026	3/4	230 V-I	1 340	2 160	1 710	1 315	980	0,71	[1,89]	9	0 360	1 700	1/4"-1/2"	74	31	
	MDF-MY-1 033	1	230 V-I	1 780	2 700	2 160	1 685	1 280	0,82	[2,11]	9	0 360	1 700	1/4"-5/8"	76	31	
	MDF-MY-1 053	1 1/2	230 V-I *	2 425	3 975	3 115	2 360	1 710	1,04	[2,33]	12	0 360	1 700	1/4"-3/4"	88	32	
	MDF-MY-1 074	2	230 V-I *	3 150	5 080	4 005	3 045	2 210	1,37	[2,29]	16	0 360	1 700	1/4"-3/4"	90	36	
	MDF-MY-2 086	4	400 V-III	4 230	6 800	5 360	4 130	3 090	1,84	[2,32]	13	0 450	3 600	3/8"-7/8"	98	39	
	MDF-MY-2 108	5	400 V-III	5 175	8 280	6 535	5 035	3 765	2,23	[3,23]	16	0 450	3 600	3/8"-7/8"	100	38	
MDF-MY-2 136	6 1/2	400 V-III	6 575	10 140	8 200	6 385	4 835	2,99	[2,87]	19	0 450	3 600	3/8"-1 1/8"	103	34		
R449A	MDF-MG-0 008	1/3	230 V-I	570	965	790	635	490	0,36	[1,71]	4	0 200	350	1/4"-3/8"	51	28	
	MDF-MG-0 010	3/8	230 V-I	735	1 210	1 000	805	635	0,46	[1,72]	5	0 200	350	1/4"-3/8"	51	29	
	MDF-MG-0 012	1/2	230 V-I	870	1 395	1 160	945	755	0,54	[1,74]	6	0 200	350	1/4"-3/8"	51	29	
	MDF-MG-1 014	1/2	230 V-I	1 075	1 870	1 515	1 200	930	0,66	[1,71]	6	0 360	1 700	1/4"-1/2"	66	32	
	MDF-MG-1 016	5/8	230 V-I	1 220	2 200	1 770	1 385	1 040	0,74	[1,77]	7	0 360	1 700	1/4"-1/2"	76	32	
	MDF-MG-1 018	3/4	230 V-I	1 525	2 630	2 140	1 710	1 310	0,88	[1,85]	8	0 360	1 700	1/4"-1/2"	76	32	
	MDF-MG-1 024	1	230 V-I	1 940	3 485	2 815	2 195	1 650	1,01	[2,04]	12	0 360	1 700	3/8"-5/8"	78	32	
	MDF-MG-1 026	1 1/4	230 V-I *	2 185	3 790	3 085	2 455	1 870	1,13	[2,05]	13	0 360	1 700	3/8"-5/8"	78	32	
	MDF-MG-1 034	1 1/2	230 V-I *	2 820	4 765	3 895	3 125	2 420	1,60	[1,91]	16	0 360	1 700	3/8"-5/8"	78	32	
	MDF-MG-1 038	1 3/4	400 V-III	3 105	5 315	4 320	3 440	2 650	1,53	[2,11]	7	0 450	3 200	3/8"-5/8"	81	29	
	MDF-MG-2 048	2	400 V-III	3 985	6 805	5 525	4 410	3 410	1,89	[2,25]	8	0 450	3 600	3/8"-3/4"	85	26	
	MDF-MG-2 054	2 1/2	400 V-III	4 595	7 660	6 250	5 020	3 950	2,09	[2,35]	9	0 450	3 600	3/8"-3/4"	86	26	
	MDF-MG-2 060	3	400 V-III	5 300	8 655	7 105	5 750	4 575	2,48	[3,26]	10	0 450	3 600	3/8"-3/4"	87	26	
	MDF-MG-2 068	3 1/2	400 V-III	5 975	9 635	7 955	6 460	5 160	2,85	[3,14]	10	0 450	3 600	1/2"-3/4"	88	25	

### 230 V-I-50 Hz\* / 400 V-III-50 Hz | R449A / R452A | Baja temperatura | Condensadoras Silenciosas | Compresor hermético | R449A

REFRIGERANTE	SERIE / MODELO SERIES / MODEL SÉRIES / MODÈLE	COMPRESOR COMPRESSOR COMPRESSEUR		POTENCIA FRIGORÍF. POWER PUISSANCE FRIGORIF. EN13215 (W) <sup>(1)</sup> T° EVAP. -35 °C	POT. FRIGOR./POWER/PUISSANCE FRIGORIF. (W) <sup>(2)</sup> TEMP. EVAPORAC./EVAPORATION TEMP./TEMP. D'ÉVAPOR.			POTEN. ABSOR. NOMINAL NOMINAL POW. ABSOR. PUISS. ABSORC. NOMINALE (kW)	[C.O.P.] S.E.P.R. <sup>(3)</sup>	INTENS. MÁX. ABSORCIÓN MAX. ABSOR. POWER INTENS. MAX. ABSOR. (A)	VENTILADOR FAN VENTILATEUR Ø mm	CAUDAL FLOW RATE DÉBIT D'AIR (m³/h)	CONEXIÓN FRIGORÍFICA COOLING CONNECTION CONNECTION FRIGORIFIQUE LIQ - GAS	PESO WEIGHT POIDS (kg)	NIVEL PRES. SONORA SOUND PRESS. LEVEL NIVEAU PRESS. SONORE dB(A) <sup>(6)</sup>	PVP PRICE PVP (€)
		CV	TENSIÓN	-25 °C	-30 °C	-35 °C	INTENS. MÁX. ABSORCIÓN MAX. ABSOR. POWER INTENS. MAX. ABSOR. (A)	Ø mm	(m³/h)	LIQ - GAS	(kg)	NIVEL PRES. SONORA SOUND PRESS. LEVEL NIVEAU PRESS. SONORE dB(A) <sup>(6)</sup>	PVP PRICE PVP (€)			
R449A	BDF-MG-0 018	5/8	230 V-I	335	795	600	<b>415</b>	0,43	[0,96]	6	0 200	350	1/4"-1/2"	58	28	
	BDF-MG-1 026	3/4	230 V-I	545	1 285	945	<b>665</b>	0,67	[0,97]	9	0 360	1 700	1/4"-1/2"	76	31	
	BDF-MG-1 034	1 1/4	230 V-I	720	1 690	1 245	<b>865</b>	0,90	[0,95]	10	0 360	1 700	3/8"-5/8"	79	32	
	BDF-MG-1 055	1 3/4	230 V-I*	920	2 425	1 745	<b>1 160</b>	1,17	[0,99]	16	0 360	1 700	3/8"-5/8"	85	34	
	BDF-MG-1 075	2 1/2	230 V-I*	1 360	3 125	2 375	<b>1 645</b>	1,56	[1,06]	24	0 360	1 700	3/8"-5/8"	90	36	
	BDF-MG-2 096	3 1/2	400 V-III	1 570	4 055	2 930	<b>1 945</b>	1,64	[1,21]	11	0 450	3 600	3/8"-3/4"	98	39	
	BDF-MG-2 108	4	400 V-III	2 015	4 700	3 475	<b>2 390</b>	1,95	1,65	13	0 450	3 600	3/8"-7/8"	98	37	
	BDF-MG-2 136	5	400 V-III	2 665	5 855	4 425	<b>3 125</b>	2,59	1,60	15	0 450	3 600	3/8"-7/8"	98	32	
	BDF-MG-3 215	7 1/2	400 V-III	4 040	9 125	6 865	<b>4 785</b>	3,83	1,65	24	2x 0 450	6 500	1/2"-1 1/8"	149	39	
	BDF-MG-3 271	10	400 V-III	5 840	11 755	9 020	<b>6 600</b>	5,13	1,68	28	2x 0 450	6 500	1/2"-1 1/8"	149	39	

10

Serie / Series / Série **SIGILUS**

+Info: [www.infrico.com](http://www.infrico.com)

**Versión multiservicio con sistema VRC**  
 Multiservice version VRC system  
 Version multiservice avec système VRC



COMPRESOR HERMÉTICO R134 a			
R134a	Versión Axial VRC	Potencia Frigorífica	Precio
	Serie / Modelo	(W) T° EVAP. -10 °C	Price (€)
	MDF-VY-2 086	4.150	
	MDF-VY-2 108	5.040	
	MDF-VY-2 136	6.710	
	MDF-VY-3 171	7.440	
	MDF-VY-3 215	9.390	
MDF-VY-3 271	12.720		

  

MEDIA TEMPERATURA R449A			
R449A	MDF-VG-1 038	3.540	
	MDF-VG-2 048	4.520	
	MDF-VG-2 054	5.140	
	MDF-VG-2 060	5.880	
	MDF-VG-2 068	6.600	
	MDF-VG-3 086	6.950	
	MDF-VG-3 108	9.200	
	MDF-VG-4 136	11.750	
	MDF-VG-4 160	13.390	

**Opciones / Options / Options**

	Precio Price (€) Prix
Cambio a alimentación 400 V-III-50 Hz	
Separador de aceite (ya incluido en versiones -V)	
Válvula solenoide integrada con cuerpo y bobina (sólo en versiones -N y -M)	
Recubrimiento anticorrosión de batería	
Rejilla exterior de protección de batería	
Control de condensación proporcional por variación de velocidad del motoventilador	
Versión electrónica	

Serie 0

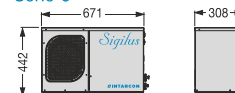

Serie 1

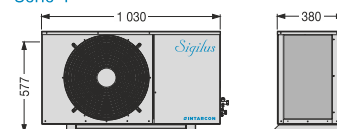

Serie 2

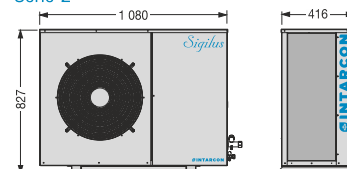

Serie 3

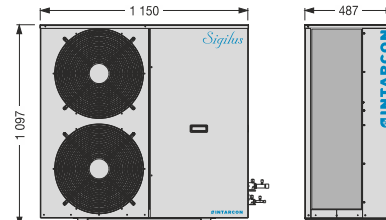

Dimensiones Dimensions Dimensions [mm]	A	B	C
SERIE 0	671	308	442
SERIE 1	1 030	380	580
SERIE 2	1 080	416	827
SERIE 3	1 150	487	1 097
SERIE 4	1 150	487	1 346



# Motocondensadoras Condensing units Motocondensateurs

## Opciones / Options / Options

Cambio a alimentación 400 V-III-50 Hz
Separador de aceite [ya incluido en versiones -V]
Resistencia de Cártér
Válvula solenoide integrada con cuerpo y bobina [sólo en versiones -N y -M]
Recubrimiento anticorrosión de batería
Compuerta de descarga antirretorno
Tolva de adaptación a conducto circular [series 3, 4]
Control condensación proporcional por variación de velocidad
Versión electrónica

Precio  
Price (€)  
Prix



### 230 V-I-50 Hz / 400 V-III-50 Hz | R134a - R449A / R404A | Media temperatura

REFRIGERANTE	VERSIÓN AXIAL		POT. FRIGOR./POWER/PUISSANCE FRIGORIF. (W)				POTEN. ABSOR. NOMINAL / POW. ABSOR. NOMINALE (kW)	INTENS. MÁX. ABSORCIÓN (C.O.P.) / S.E.P.R. (3)	CONEXIÓN FRIGORIF. / COOLING CONNECTION LIQ - GAS	PESO / WEIGHT (kg)	NIVEL PRES. SONORA / SOUND PRESS. LEVEL (dB(A))	PVP / PRICE (€)	VERSIÓN CENTRÍFUGA				
	SERIE / MODELO / SERIES / MODEL / SÉRIES / MODÈLE	CV	TENSIÓN	EN13215 (W) <sup>(1)</sup>	TEMP. EVAPORAC./EVAPORATION TEMP./TEMP. D'ÉVAPOR.								CAUDAL (m³/h)	P.E.D. (3) (Pa)	PVP PRICE (€)		
					0 °C	-5 °C										-10 °C	-15 °C
R134a	MDH-MY-0 010	3/8	230 V-I	575	890	715	565	430	0,37	[1,54]	4	1/4"-3/8"	45	29	MDH-CMY-0 010	375	8
	MDH-MY-0 015	1/2	230 V-I	800	1 215	985	785	600	0,51	[1,58]	5	1/4"-3/8"	47	32	MDH-CMY-0 015	375	8
	MDH-MY-1 015	1/2	230 V-I	840	1 305	1 050	825	630	0,50	[1,69]	5	1/4"-1/2"	50	32	MDH-CMY-1 015	575	8
	MDH-MY-1 026	3/4	230 V-I	1 225	1 910	1 530	1 200	900	0,72	[1,72]	9	1/4"-1/2"	58	30	MDH-CMY-1 026	575	8
	MDH-MY-1 033	1	230 V-I	1 555	2 325	1 890	1 505	1 155	0,83	[1,87]	9	1/4"-1/2"	60	33	MDH-CMY-1 033	575	8
	MDH-MY-2 053	1 1/2	230 V-I *	2 210	3 505	2 785	2 130	1 565	1,06	[1,77]	12	1/4"-5/8"	70	38	MDH-CMY-2 053	1 000	12
	MDH-MY-3 074	2	230 V-I *	3 045	4 855	3 845	2 940	2 140	1,36	[2,08]	16	1/4"-3/4"	90	44	MDH-CMY-3 074	1 500	14
	MDH-MY-4 086	4	400 V-III	4 160	6 660	5 270	4 065	3 040	2,02	[2,23]	14	3/8"-7/8"	97	48	MDH-CMY-4 086	3 500	10
	MDH-MY-4 108	5	400 V-III	5 065	7 940	6 380	4 935	3 690	2,46	[2,09]	17	3/8"-7/8"	99	45	MDH-CMY-4 108	3 500	10
	MDH-MY-4 136	6 1/2	400 V-III	6 410	9 595	7 825	6 215	4 720	3,33	2,85	20	3/8"-1 1/8"	102	44	MDH-CMY-4 136	3 500	10
R449A	MDH-MG-0 008	1/3	230 V-I	570	975	800	640	490	0,40	[1,50]	4	1/4"-3/8"	46	31	MDH-CMG-0 008	375	8
	MDH-MG-0 010	3/8	230 V-I	745	1 225	1 010	815	640	0,50	[1,57]	5	1/4"-3/8"	46	34	MDH-CMG-0 010	375	8
	MDH-MG-0 012	1/2	230 V-I	880	1 415	1 175	955	760	0,58	[1,61]	6	1/4"-3/8"	46	34	MDH-CMG-0 012	375	8
	MDH-MG-1 014	1/2	230 V-I	1 065	1 740	1 435	1 165	925	0,67	[1,69]	6	1/4"-1/2"	50	34	MDH-CMG-1 014	575	8
	MDH-MG-1 016	5/8	230 V-I	1 190	1 985	1 630	1 310	1 020	0,75	[1,71]	7	1/4"-1/2"	60	34	MDH-CMG-1 016	575	8
	MDH-MG-1 018	3/4	230 V-I	1 440	2 325	1 925	1 565	1 240	0,90	[1,73]	8	1/4"-1/2"	60	34	MDH-CMG-1 018	575	8
	MDH-MG-2 024	1	230 V-I	1 915	3 215	2 630	2 105	1 635	1,06	[1,93]	12	3/8"-5/8"	60	35	MDH-CMG-2 024	1 000	12
	MDH-MG-2 026	1 1/4	230 V-I *	2 130	3 485	2 870	2 320	1 830	1,19	[1,91]	13	3/8"-5/8"	61	36	MDH-CMG-2 026	1 000	12
	MDH-MG-2 034	1 1/2	230 V-I *	2 635	4 240	3 525	2 865	2 260	1,66	[1,72]	16	3/8"-5/8"	61	37	MDH-CMG-2 034	1 000	12
	MDH-MG-3 038	1 3/4	400 V-III	2 985	4 890	4 025	3 250	2 555	1,51	[2,12]	6	3/8"-5/8"	78	39	MDH-CMG-3 038	1 500	14
MDH-MG-4 048	2	400 V-III	3 955	6 685	5 430	4 345	3 390	2,07	[2,06]	13	3/8"-3/4"	95	36	MDH-CMG-4 048	3 500	10	
MDH-MG-4 054	2 1/2	400 V-III	4 535	7 515	6 145	4 940	3 900	2,30	[2,13]	14	3/8"-3/4"	96	36	MDH-CMG-4 054	3 500	10	
MDH-MG-4 060	3	400 V-III	5 220	8 435	6 980	5 655	4 505	2,74	2,97	15	3/8"-3/4"	97	35	MDH-CMG-4 060	3 500	10	
MDH-MG-4 068	3 1/2	400 V-III	5 880	9 330	7 775	6 345	5 075	3,16	2,86	15	1/2"-3/4"	98	35	MDH-CMG-4 068	3 500	10	

### 230 V-I-50 Hz\* / 400 V-III-50 Hz | R449A - R452A | Baja temperatura | Compresor hermético

REFRIGERANTE	VERSIÓN AXIAL		POT. FRIGOR./POWER/PUISSANCE FRIGORIF. (W)				POTEN. ABSOR. NOMINAL / POW. ABSOR. NOMINALE (kW)	INTENS. MÁX. ABSORCIÓN (C.O.P.) / S.E.P.R. (3)	CONEXIÓN FRIGORIF. / COOLING CONNECTION LIQ - GAS	PESO / WEIGHT (kg)	NIVEL PRES. SONORA / SOUND PRESS. LEVEL (dB(A))	PVP / PRICE (€)	VERSIÓN CENTRÍFUGA				
	SERIE / MODELO / SERIES / MODEL / SÉRIES / MODÈLE	CV	TENSIÓN	EN13215 (W) <sup>(1)</sup>	TEMP. EVAPORAC./EVAPORATION TEMP./TEMP. D'ÉVAPOR.								CAUDAL (m³/h)	P.E.D. (3) (Pa)	PVP PRICE (€)		
					-25 °C	-30 °C										-35 °C	SÉRIES / MODEL / SÉRIES / MODÈLE
R449A	BDH-MG-1 026	3/4	230 V-I	540	1 220	930	660	0,67	[0,96]	9,0	1/4"-1/2"	51	31	BDH-CMG-1 026	575	8	
	BDH-MG-1 034	1 1/4	230 V-I	715	1 525	1 170	860	0,90	[0,95]	10,0	1/4"-1/2"	52	33	BDH-CMG-1 034	575	8	
	BDH-MG-2 055	1 3/4	230 V-I	915	2 265	1 700	1 165	1,21	[0,95]	16,0	3/8"-5/8"	61	41	BDH-CMG-2 055	1 000	12	
	BDH-MG-2 075	2 1/2	230 V-I	1 355	2 855	2 200	1 620	1,60	[1,02]	24,0	3/8"-5/8"	66	44	BDH-CMG-2 075	1 000	12	
	BDH-MG-3 096	3 1/2	400 V-III	1 595	3 665	2 755	1 875	1,68	[1,16]	11	3/8"-3/4"	88	49	BDH-CMG-3 096	1 500	14	
	BDH-MG-4 108	4	400 V-III	2 010	4 630	3 450	2 400	2,08	1,62	14,0	3/8"-7/8"	108	47	BDH-CMG-4 108	3 500	10	
	BDH-MG-5 136	5	400 V-III	2 665	5 995	4 490	3 150	2,72	1,61	16,0	1/2"-1 1/8"	152	42	BDH-CMG-5 136	3 600	10	
	BDH-MG-5 215	7 1/2	400 V-III	4 040	8 750	6 575	4 730	3,92	1,60	24,0	1/2"-1 1/8"	183	49	BDH-CMG-5 215	3 600	10	



Serie / Series / Série **INTARBOX**

+Info: [www.infrico.com](http://www.infrico.com)

**Versión multiservicio con sistema VRC**  
 Multiservice version VRC system  
 Version multiservice avec système VRC



MEDIA TEMPERATURA - COMPRESOR HERMÉTICO		
Versión Axial VRC	Potencia Frigorífica (W) T° EVAP. -10 °C	Precio Price (€)
R134a	MDH-VY-4 086	4.020
	MDH-VY-4 108	4.870
	MDH-VY-4 136	6.500
	MDH-VY-5 171	7.560
	MDH-VY-5 215	9.310
	MDH-VY-5 271	12.600
	MEDIA TEMPERATURA R449A	
R449A	MDH-VG-3 038	3.270
	MDH-VG-4 048	4.420
	MDH-VG-4 054	5.030
	MDH-VG-4 060	5.740
	MDH-VG-4 068	6.410
	MDH-VG-5 086	7.270
	MDH-VG-5 108	9.290

MEDIA TEMPERATURA - COMPRESOR HERMÉTICO	
Versión Centrífuga	Precio Price (€)
Serie / Modelo	
MDH-CVY-4086	
MDH-CVY-4108	
MDH-CVY-4136	
MDH-CVY-5171	
MDH-CVY-5215	
MDH-CVY-5271	
MEDIA TEMPERATURA R449A	
MDH-CVG-3038	
MDH-CVG-4048	
MDH-CVG-4054	
MDH-CVG-4060	
MDH-CVG-4068	
MDH-CVG-5086	
MDH-CVG-5108	

**Dimensiones DH-Axial / Dimensions DH-Axial**

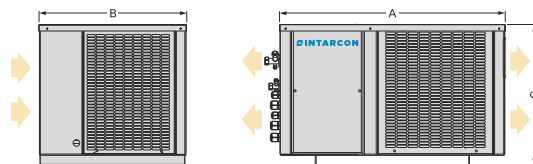

Dimensiones (mm) Dimensions	A	B	C
SERIE 0	600	396	355
SERIE 1	665	435	416
SERIE 2	835	435	500
SERIE 3	925	580	515
SERIE 4	1000	615	585
SERIE 5	1289	757	657

**Dimensiones DH-centrífuga / Dimensions dh-centrífugal**

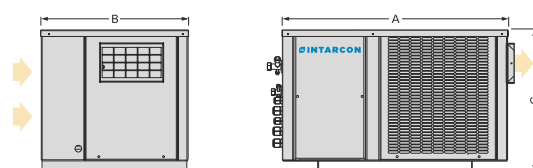

Dimensiones (mm) Dimensions	A	B	C	Embocadura turbina
SERIE 0	600	396	355	185X115
SERIE 1	665	435	416	185X115
SERIE 2	835	435	500	230X130
SERIE 3	925	580	515	236X266
SERIE 4	1000	615	585	305X266
SERIE 5	1289	757	657	305X266

Opciones Options	Precio Price (€) Prix
Cambio a alimentación 400 V-III-50 Hz	
Separador de aceite [ya incluido en versiones -V]	
Resistencia de Cáster	
Válvula solenoide integrada con cuerpo y bobina [sólo en versiones -N y -M]	
Recubrimiento anticorrosión de batería	
Compuerta de descarga antirretorno	
Tolva de adaptación a conducto circular [series 3, 4]	
Control condensación proporcional por variación de velocidad	Axial: Centrífuga:
Versión electrónica	



# Sist. de refrig. para supermercados con condensación en circuito de agua con carga reducida

## Supermarket refriger. syst. with indirect condensation by water circuit with reduced load

### Syst. de réfrig. pour supermarchés à condensation avec circuit d'eau et charge réduite

#### Grupos condensados por agua

##### Descripción:

Grupos frigoríficos condensados por agua para refrigeración a temperatura positiva, de tamaño muy compacto y silencioso, diseñados para instalación en pared, suelo o sobre el servicio frigorífico.

##### Características:

Carrocería en chapa de acero galvanizado prelacado, con revestimiento fonoabsorbente, con registro frontal desmontable para acceso a compresor y cuadro eléctrico.

Inyección de líquido en modelos de baja temperatura con R 449 A

- Alimentación 400 V-III-50 Hz.
- Compresor scroll sobre soportes antivibratorios con aislamiento acústico.
- Condensador de placas soldadas de acero inoxidable.

Circuito frigorífico con recipiente, filtro, visor, válvula solenoide, presostatos de AP y BP y válvulas de servicio.

· Circuito hidráulico de condensación en tubo de cobre con conexiones roscadas.

· Cuadro eléctrico de control con protección diferencial y magnetotérmica.

#### Aeroenfriadores con grupo hidráulico

##### Descripción:

Aeroenfriadores de agua con grupo hidráulico, en construcción silenciosa, diseñados para la evacuación del calor del bucle de agua de condensación de equipos frigoríficos.

##### Características:

Motoventiladores axiales silenciosos de bajas revoluciones, montados en tobera, hélices equilibradas dinámicamente y rejillas de protección exterior.

· Batería de agua de alta eficiencia de tubos de cobre y aletas de aluminio.

· Grupo hidráulico incorporado formado por bomba circuladora electrónica con caudal variable, vaso de expansión, válvula de seguridad, filtro de malla, termomanómetros y toma de llenado/vaciado.

· Conexiones hidráulicas a roscar.

· Cuadro eléctrico de potencia, con protección de bomba hidráulica y motoventilador, y regulador de velocidad.

#### Water condensing units

##### Description:

Air-coolers with condensation by cooling water at positive temperature. very compact size and quiet, designed for wall, floor or above refrigeration services.

##### Characteristics:

Casing in prepainted galvanized steel sheet, with sound-absorbing insulation with removable front panel for access to the compressor and the electrical panel liquid injection in low temperature model with R-449 A.

- Power supply 400 V-III-50 Hz.
- Scroll compressor with sound insulation packet.
- Refrigeration circuit with stainless steel brazed plates heat exchanger.
- Ceramic drier filter, sight gauge for HP and LP solenoid valves.
- Hydraulic condensation circuit made of copper pipe with threaded connections.
- Electrical control panel with differential thermomagnetic protection.

#### Drycooler with built-in hydraulic group

##### Description:

Drycoolers with built-in hydraulic group, in a low-noise construction, designed for heat dissipation of the refrigeration equipment condensation water loop.

##### Characteristics:

Low speed axial fans, with dynamically balanced blades, supported by air nozzle and external protection grilles.

· High efficiency water coils with copper pipes and aluminum fins. Hydraulic group with variable flow electronic pump, expansion valve, safety valve, filter, thermomanometers and auto-fill valve included.

· Threaded hydraulic connections.

· Electric power panel, with protection of hydraulic pump and fan motor

#### Groupes condensés à eau

##### Description:

Groupes frigorifiques condensés à eau pour la réfrigération à température positive, de dimensions très compactes et silencieux, conçus pour installation murale, sol ou sur le mobilier frigorifique.

##### Caractéristiques:

Carrosserie en tôle d'acier galvanisée prélaquée, avec revêtement phonoabsorbant, avec registre frontal démontable pour l'accès au compresseur et tableau électrique.

Alimentation électrique 400V-III-50Hz.

Compresseur hermétique scroll sur des supports antivibratoires avec isolation acoustique.

Précharge de gaz R134a.

Condenseur à plaques brasées d'acier inoxydable. Circuit frigorifique avec bouteille de liquide, filtre, voyant de liquide, vanne solénoïde, pressostats HP et BP et vannes de service.

Circuit hydraulique de condensation en tube de cuivre avec des raccords filetés.

Tableau électrique de contrôle avec protection différentiel y magnétothermique.

#### Aérefroidisseurs avec groupe hydraulique

##### Description:

Les aérefroidisseurs d'eau avec groupe hydraulique, en construction silencieux, conçus pour l'évacuation de la chaleur de la boucle d'eau de condensation des équipements frigorifiques.

##### Caractéristiques:

Motoventilateurs axiaux silencieux de basse vitesse, montés en buse, hélices équilibrés dynamiquement et grilles de protection extérieure.

Batterie de refroidissement d'eau d'haute efficacité en tubes de cuivre et ailettes d'aluminium.

Groupe hydraulique incorporé composé d'une pompe électronique de circulation d'eau à débit variable, valve d'expansion, vanne de sécurité, filtre à tamis, thermomanomètre et prise de remplissage.

Connexions hydrauliques sur tableau électrique de puissance, avec protection de la pompe hydraulique et des motoventilateurs.

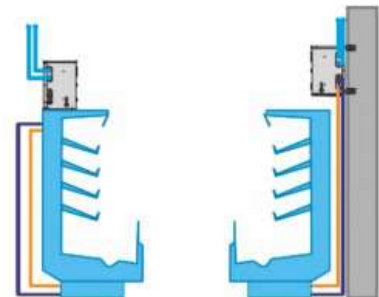
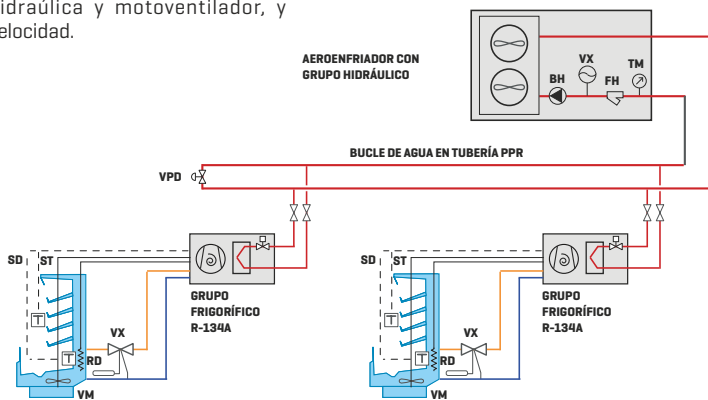

**VPD:** válvula de presión diferencial / differential pressure valve / Vanne de pression différentielle

**ST:** sonda termostato / thermostat probe / Sonde thermostatique

**SD:** sonda desescarche / defrost probe / Sonde de dégivrage

**VX:** válvula de expansión / expansion valve / Détendeur thermostatique

**VM:** motoventilador / motor fan / Motoventilateur

**RD:** resistencia de desescarche / defrost heater / Résistance de dégivrage

**BH:** bomba hidráulica / hydraulic pump / Pompe hydraulique

**FH:** filtro hidráulico de malla / hydraulic mesh filter / Filtre hydraulique à tamis

**TM:** termomanómetro / thermomanometer / Thermomanomètre

**VX:** vaso de expansión / buffer tank / Vanne d'expansion

Serie / Series / Série **WATERLOO**

+Info: [www.infrico.com](http://www.infrico.com)

**Grupos condensados por agua / Water condensing units/ Unités de condensation à eau**



Dimensiones (mm)			
	A	B	C
serie 1	832	355	531
serie 2	957	375	600

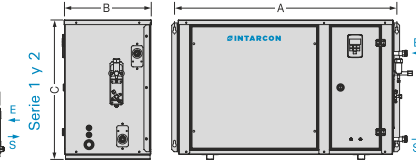
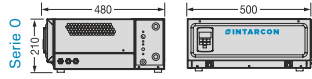

Opcional / Optional / Option

**Carga de refrigerante para 5 metros de tubería**  
Refrigerant charge for 5 meters of pipe  
Charge de réfrigérant pour 5 mètres de tube

**400 V-III-50 Hz | R134a - R449A | R404A | Media temperatura - Compressor scroll**

Refrigerante	Compressor	Compressor			Potencia frigorífica [W] <sup>(1)</sup>			Potencia absorb. nominal [kW]	Intens. máx. absorb. [A]	Caudal de agua [l/h]	Conexiones hidráulicas	Pérdida de carga [kPa]	Conexión frigorífica Liq-Gas	Peso Poids [kg]	S.PL N.P.A. dB(A) <sup>(e)</sup>	PVP [€]	
		Serie / Modelo	CV	Modelo	Tensión	Temperatura de evaporación											
						0 °C	-5 °C										-10 °C
R134a	1x Scroll	MDM-SMY-1 009	1 1/4	ZS09	400 V-III *	1 855	1 540	1 270	0,7	3	350	3/4"	0,5	1/4"-5/8"	34	40	
		MDM-SMY-1 015	2	ZB15	400 V-III *	2 840	2 360	1 945	1,1	5	500	3/4"	0,5	1/4"-5/8"	43	37	
		MDM-SMY-1 021	3	ZB21	400 V-III *	4 250	3 520	2 890	1,5	7	750	3/4"	0,5	1/4"-3/4"	53	40	
		MDM-SMY-1 029	4	ZB29	400 V-III	5 245	4 340	3 585	2,0	10	950	1"	0,5	3/8"-7/8"	53	40	
		MDM-SMY-1 038	5	ZB38	400 V-III	7 095	5 890	4 835	2,5	13	1 250	1"	0,5	3/8"-7/8"	68	53	
		MDM-SMY-1 045	6	ZB45	400 V-III	8 320	6 915	5 695	2,9	13	1 500	1"	0,5	3/8"-1 1/8"	70	43	
		MDM-SMY-1 057	8	ZB57	400 V-III	10 575	8 780	7 230	4,0	16	1 950	1 1/4"	0,5	1/2"-1 1/8"	75	50	
		MDM-SMG-1 009	1 1/4	ZS09	400 V-III *	3 095	2 585	2 135	1,1	2	500	1"	0,5	1/4"-5/8"	34	40	
R449A	1x Scroll	MDM-SMG-1 015	2	ZB15	400 V-III *	4 860	4 050	3 340	1,7	5	800	1"	0,5	3/8"-5/8"	43	37	
		MDM-SMG-1 021	3	ZB21	400 V-III *	7 365	6 140	5 080	2,4	7	1 200	1"	0,5	3/8"-7/8"	53	40	
		MDM-SMG-1 029	4	ZB29	400 V-III	9 610	8 020	6 635	3,2	10	1 500	1 1/4"	0,5	3/8"-7/8"	53	40	
		MDM-SMG-1 038	5	ZB38	400 V-III	12 445	10 380	8 540	4,1	13	2 000	1 1/4"	0,5	3/8"-7/8"	68	53	
		MDM-SMG-1 045	6	ZB45	400 V-III	14 715	12 270	10 130	4,7	13	2 500	1 1/4"	0,5	3/8"-1 1/8"	70	43	

**400 V-III-50 Hz | R449A | Baja temperatura - Compressor scroll**

Refrigerante	Compressor	Compressor			Potencia frigorífica [W] <sup>(1)</sup>				Potencia absorb. nominal [kW]	Intens. máx. absorb. [A]	Caudal de agua [l/h]	Conexiones hidráulicas	Pérdida de carga [MCA]	Conexión frigorífica Liq-Gas	Peso Poids [kg]	S.PL N.P.A. dB(A) <sup>(e)</sup>	PVP [€]	
		Serie / Modelo	CV	Modelo	Tensión	Temperatura de evaporación												
						-20 °C	-25 °C	-30 °C										-35 °C
R449A	1x Scroll	BDM-SMG-1 006	2	ZF06	400 V-III	2 360	1 910	1 525	1 195	1,5	5	550	3/4"	0,5	1/4"-5/8"	45	39	
		BDM-SMG-1 009	3	ZF09	400 V-III	3 210	2 590	2 070	1 620	1,9	6	700	3/4"	0,5	3/8"-3/4"	54	44	
		BDM-SMG-1 011	3 1/2	ZF11	400 V-III	4 050	3 275	2 610	2 045	2,3	8	850	3/4"	0,5	3/8"-3/4"	55	45	
		BDM-SMG-2 013	4	ZF13	400 V-III	4 595	3 715	2 970	2 325	2,5	9	950	1"	0,5	3/8"-7/8"	55	47	
		BDM-SMG-2 015	5	ZF15	400 V-III	5 640	4 560	3 640	2 850	3,3	10	1 250	1"	0,5	3/8"-7/8"	73	47	
		BDM-SMG-2 018	6	ZF18	400 V-III	6 685	5 400	4 310	3 375	3,9	14	1 500	1"	0,5	3/8"-1 1/8"	78	47	
		BDM-SMG-2 025	8	ZF25	400 V-III	8 400	6 795	5 430	4 265	4,2	16	2 000	1 1/4"	0,5	3/8"-1 1/8"	78	47	

**Waterloop aeroenfriadores con grupo hidráulico / Drycooler with built-in hydraulic group / Refroidisseurs à air avec groupe hydraulique**

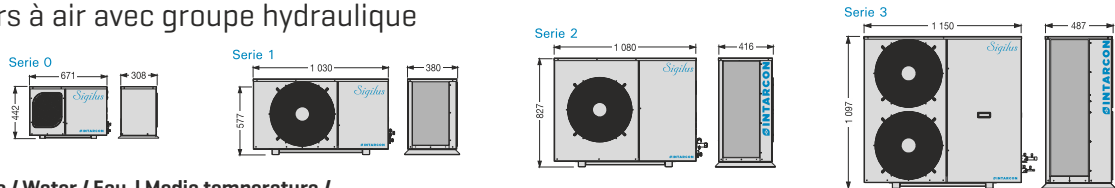

**230-V-50 Hz | Agua / Water / Eau | Media temperatura /**

Series / Modelo	Tensión	Potencia térmica de intercambio [W] <sup>(1)</sup>	Caudal de aire [m³/h]	Ventilador Ø mm	Caudal de agua [l/h]	Potencia absorb. nominal [kW]	Intens. máx. absorb. [A]	Presión disponible [kPa]	Conexiones hidráulicas	Peso [kg]	S.PL dB(A) <sup>(e)</sup>	PVP [€]
CWF-0	230 V-I	3 000	1 700	1x Ø360	500	0,14	1,1	100	3/4"	76	30	
CWF-1	230 V-I	4 700	3 200	1x Ø450	750	0,22	1,8	100	3/4"	79	26	
CWF-2	230 V-I	6 000	3 700	1x Ø450	1 000	0,24	2,0	100	1"	81	26	
CWF-3	230 V-I	10 000	6 500	2x Ø450	1 500	0,44	3,6	100	1"	101	29	
CWF-4	230 V-I	12 000	7 000	2x Ø450	2 000	0,48	3,9	100	1 1/4"	113	29	
CWF-6	230 V-I	20 000	13 000	4x Ø450	3 000	0,88	7,0	100	1 1/2"	160	32	
CWF-8	230 V-I	24 000	14 000	4x Ø450	4 000	0,96	7,5	100	1 1/2"	185	32	

Los datos técnicos están sujetos a posibles variaciones que serán actualizadas periódicamente en las fichas técnicas del producto, disponibles en la web / The technical data are subject to possible variations that will be updated periodically in the technical data sheets of the product, which are available on the website / Les données techniques peuvent varier et seront actualisées dans les fiches techniques du produit, disponibles sur le site web.



## Centrales frigoríficas Refrigeration units Centrales frigorífiques

### INTARCUBE CENTRÍFUGA

Motocondensadoras y centrales de refrigeración compactas, de uno a tres compresores, con condensación centrífuga, para media y baja temperatura, incorporan cuadro eléctrico y regulación electrónica (según versión) con control de condensación.

Self-contained air-cooled refrigeration centrals, from 1 to 3 compressors, for positive and negative temperature applications, featuring control board and electronic regulation (depending on the version) with control of condensing temperature.

Motocondensateurs et installations frigorifiques compactes, de un à trois compresseurs, avec condensation centrifuge, pour moyenne et basse température, avec panneau électrique et régulation électronique (selon la version), avec contrôle de la condensation.

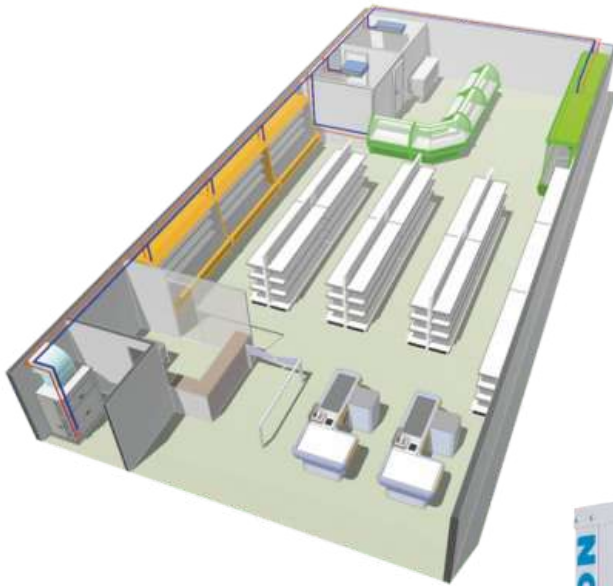

**Serie / Series / Série INTARCUBE****+Info: [www.infrico.com](http://www.infrico.com)****INTARCUBE AXIAL**

La central de refrigeración axial intarCUBE ha sido diseñada para su instalación en intemperie capaz de funcionar bajo condiciones ambientales extremas, pudiendo dar servicio a varias unidades evaporadoras. Incorpora turbinas axiales y componentes aislados para proporcionar los más bajos niveles de ruido.

Axial air-condensed chillers are designed for outdoors installations, able to operate under extreme ambient conditions, to service several evaporating units and other applications at positive and/or several evaporating units and other applications at positive and/or negative temperature, like multiservice installations, or refrigeration installations with up to 4 power steps. Thanks to axial fans and insulating components, these units are able to provide the lowest sound levels.

Le groupe de refroidissement axial intarCUBE a été conçu pour leur installation extérieure, capable de fonctionner sous conditions environnementales extrêmes, il peut servir plusieurs unités d'évaporation. Il intègre des turbines axiales et des composants isolés pour garantir les niveaux de bruit les plus faibles.

**Unidades motocondensadoras silenciosas / Low noise condensing units / Unités motocondensateurs silencieuses**

**Cuadro eléctrico integrado con protección diferencial (según modelo) y magnetotérmica**  
Integrated electrical panel with differential protection (depending on model and circuit breaker)  
Tableau électrique intégré avec protection différentielle (selon le modèle), et magnétothermique

**Manómetros de AP y BP (serie 6, 7 y 8)**  
AP and BP pressure gauge (series 6, 7 and 8)  
Monomètre de AP et BP (série 6, 7 et 8)

**Conexiones frigoríficas en el lateral izquierdo**  
Refrigerator connections on the left side  
Connexions frigorifiques sur le côté gauche



**Ventiladores axiales**  
Axial fans  
Ventilateurs axiaux

**Regulación electrónica de última generación [según versión]**  
Last generation electronic regulation (depending on version)  
Contrôle électronique de dernière génération

**Batería condensadora tropicalizada con separación del flujo del aire**  
Tropicalized condensing battery with airflow separation  
Batterie condensatrice tropicalisée avec séparation de flux d'air

**Compresores con aislamiento acústico**  
Compressors with sound insulation  
Compresseurs avec isolement acoustique



# Vitrinas Pastelería

Pastry display cases / Vitrines pâtisseries et glace





Serie / Series / Série

## VGL Glace



VGL C / CN  
VGL P / PN  
VGL M  
VGL Ángulos/Angles/Angles 436-441

Serie / Series / Série

## VNZ Niza



VNZ / I / B  
VNZ DT / IDT  
VNZ HT / IHT  
VNZ M / MHD  
VNZ Ángulos/Angles/Angles 442-445

Serie / Series / Série

## VLY Lyon



VLY / I  
VLY V  
VLY B/IB  
VLY BMS  
VLY LG/ILG  
VLY M/MHD  
VLY Ángulos/Angles/Angles 446-453

Serie / Series / Série

## VBR Ámbar



VBR R / IR  
VBR HT / IHT  
VBR SS / ISS  
VBR DS / IDS  
VBR PHT / IPHT  
VBR PC  
VBR PSS / PDS 454-461

Serie / Series / Série

## VON Ónix



VON PR / PHT  
VON R / HT  
VON SS / DS 462-465

Serie / Series / Série

## VCO Combo



VCO 466-467

Serie / Series / Série

## VMG Magnus

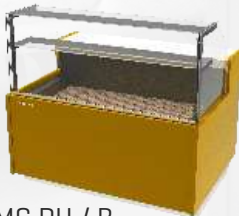

VMG RU / B  
VMG RU LG  
VMG Ángulos/Angles/Angles  
VMG P / Mueble caja  
VMG C/M/MHD 468-477

Serie / Series / Série

## VCB Coral



VCB UH 478-479

Serie / Series / Série

## VAR Aries



VAR H 480-481

Serie / Series / Série

## VBZ Ibiza



VBZ U  
VBZ SU 482-483





# 11. Vitrinas Pastelería

## Pastry Display Cases / Vitrines Pâtisseries et Glace

Flexibilidad de implantación que te permiten combinar los diferentes tipos de venta dentro de un mismo lineal.

Flexibility of implementation that allows you to combine different types of sales on the same line.

Flexibilité de mise en œuvre qui permet de combiner différents types de ventes sur une même ligne.



Decoración con colores personalizables.

Decoration with customisable colours.

Décoration avec des couleurs personnalisables.

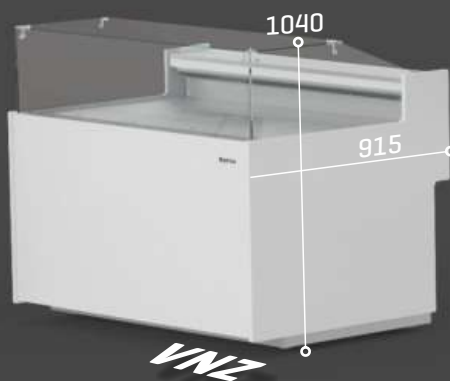
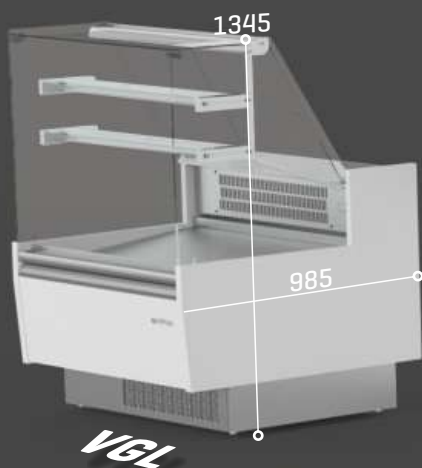

Testada en condiciones ambientales exigentes para ofrecer las mejores prestaciones en todas las condiciones ambientales.

Tested under demanding environmental conditions to provide the best performance in all environmental conditions.

Flexibilité de mise en œuvre qui permet de combiner différents types de ventes sur une même ligne.



+Info: [www.infrico.com](http://www.infrico.com)

Exposición de productos refrigerados, productos calientes y para temperatura ambiente.

Display of refrigerated products, hot products and products for ambient temperatures.

Exposition de produits réfrigérés, de produits chauds et de produits à température ambiante.

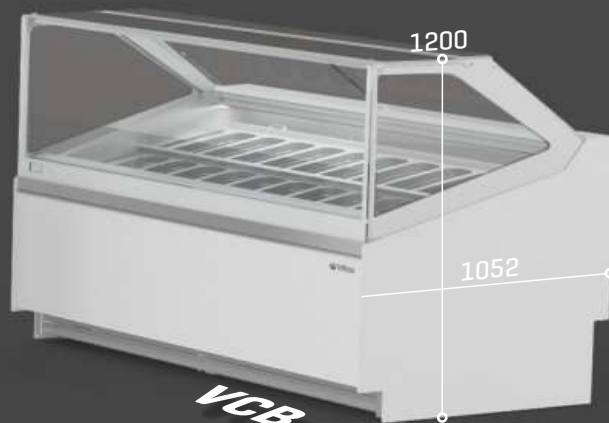
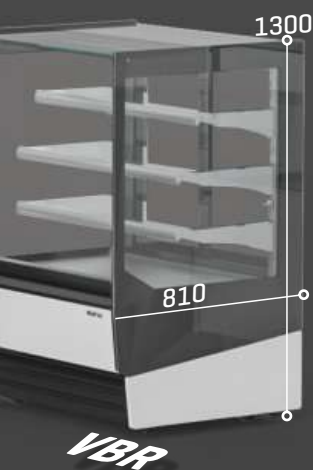





En la Ambar y VON: dos diseños diferentes, con cristal recto y curvo, para integrar dentro de todas las áreas de venta.

In the Ambar and VON: two different designs, with straight and curved glass, for integration into all sales areas.

Ambar et VON : deux modèles différents, avec verre droit et verre bombé, pour une intégration dans tous les espaces de vente.



# Vitrina expositora con reserva para pastelería / Pastry display case with storage / Vitrine d'exposition pour pâtisserie avec réserve réfrigérée

MODELO MODELE MODÈLE					
Precio Price Prix					
	<b>NEUTRO / NEUTRAL / NEUTRE</b>				
MOD.	<b>VGL 9 CN</b>	<b>VGL 12 CN</b>	<b>VGL 15 CN</b>	<b>VGL 18 CN</b>	<b>VGL 25 CN</b>
Precio Price Prix					
Medidas Mesures Mesures (mm)	998 x 985 x 1345 mm.	1310 x 985 x 1345 mm.	1622 x 985 x 1345 mm.	1935 x 985 x 1345 mm.	2560 x 985 x 1345 mm.
Temperatura Temperature Température (°C)	<b>4°C/+8°C</b>				
Clase Climática Climatic class Classe climatique (°C)	3 / 25°C				
Tensión/Frecuencia Electrical data Tension électrique	230V/1ph/50Hz				
Controlador Controller Régulateur	Digital				
Material Material Matériel (EXT/INT)	Madera lacada / Lacquered wood / Bois laqué Plano exposición / Exhibition plan / Plan d'exposition: Inox Aisi 304				
Aislamiento Isolation Isolation (mm)	40kg/m <sup>3</sup> / Free CFC's / Zero ODP-GWP				
Capacidad Capacity Capacité (L)	163	216	271	327	430
Superficie exposición Surface exhibition Surface d'exposition (m <sup>2</sup> )	0,9	1,2	1,5	1,8	2,5
Compresor Compressor Compresseur (HP)	-				
Estantes Shelving Étagères	2				
Costados [2] Sides [2] Joues [2] (mm)	<b>30+30 (INCLUIDOS / INCLUDES / INCLUS)</b>				
Sistema de frío Cooling System Système de froid	Ventilado / Ventilated / Ventilé				
Desescarche Defrost Dégivrage	Manual / Manual / Manuel				
Evaporación Evaporation Évaporation	Semiestática / Semistatic / Semiestatique				
Potencia Power Puissance (W)	292	451	451	613	653
Potencia frig. Cooling capacity Puissance Frig. (W A -10°C)	370	687	687	951	951
Consumo Consumption Consommation (kWh/ 24h)	-				
Refrigerante Refrigerant Gaz	<b>R-290</b>				
Opcional Optional Options	<b>Puertas correderas traseras / Rear sliding doors / Portes coulissantes arrière</b>  VGL 9 [KPUVGL9C+] VGL 12 [KPUVGL12C+] VGL 15 [KPUVGL15C+] VGL 18 [KPUVGL18C+] VGL 25 [KPUVGL25C+]				

Serie / Series / Série **GLACE**

+Info: [www.infrico.com](http://www.infrico.com)

VGL25C



VGL15C

**Laterales / Sides / Jous**

**Incluidos / Includes / Inclus**

**Ext. Estándar / Standar / Standard**

Ral 9016	Ral 1001	Ral 1018
Ral 2003	Ral 3003	Ral 3020
Ral 4007	Design 3504035	Ral 5015
Design 1107060	Ral 6002	Design 2108025
Ral 8017	Ral 9006	Ral 7016
Nogal-Walnut-Noyer	Wengué-Wenge-Wenge	Ral 9017



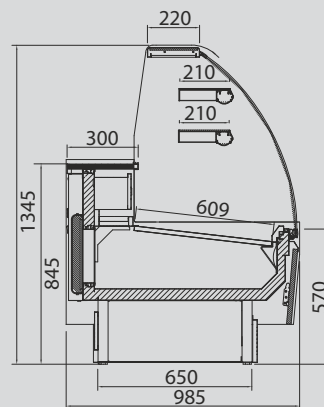

**Colores fuera de carta / Colors outside of letter / Couleurs spéciales, hors palette**

RAL		NO RAL	
Epoxi	Líquida/ Liquid/ Liquide	Epoxi	Líquida/ Liquid/ Liquide
[x unidad/x unit/x unité]		Consultar / Consulter / Consulter	
+10 días laborables / +10 work days / +10 jours ouvrés		Consultar / Consulter / Consulter	



VGL C

# Vitrina expositora con reserva para pastelería / Pastry display case with storage / Vitrine d'exposition pour pâtisserie avec réserve réfrigérée

MODELO MODELE MODÈLE					
Precio Price Prix					
	<b>NEUTRO / NEUTRAL / NEUTRE</b>				
MOD.	<b>VGL 9 PN</b>	<b>VGL 12 PN</b>	<b>VGL 15 PN</b>	<b>VGL 18 PN</b>	<b>VGL 25 PN</b>
Precio Price Prix					
Medidas Mesures Mesures (mm)	998 x 985 x 1345 mm.	1310 x 985 x 1345 mm.	1622 x 985 x 1345 mm.	1935 x 985 x 1345 mm.	2560 x 985 x 1345 mm.
Temperatura Temperature Température (°C)	<b>4°C/+8°C</b>				
Clase Climática Climatic class Classe climatique (°C)	3 / 25°C				
Tensión/Frecuencia Electrical data Tension électrique	230V/1ph/50Hz				
Controlador Controller Régulateur	Digital				
Material Material Matériel (EXT/INT)	Madera lacada / Lacquered wood / Bois laqué Plano exposición / Exhibition plan / Plan d'exposition: Inox Aisi 304				
Aislamiento Isolation Isolation (mm)	40kg/m <sup>3</sup> / Free CFC's / Zero ODP-GWP				
Capacidad Capacity Capacité (L)	163	216	271	327	430
Superficie exposición Surface exhibition Surface d'exposition (m <sup>2</sup> )	0,9	1,2	1,5	1,8	2,5
Compresor Compressor Compresseur (HP)	-				
Estantes Shelving Étagères	2				
Costados [2] Sides [2] Joues [2] (mm)	<b>30+30 (INCLUIDOS / INCLUDES / INCLUS)</b>				
Sistema de frío Cooling System Système de froid	Ventilado / Ventilated / Ventilé				
Desescarche Defrost Dégivrage	Manual / Manual / Manuel				
Evaporación Evaporation Évaporation	Semiestática / Semistatic / Semiestatique				
Potencia Power Puissance (W)	292	451	451	613	653
Potencia frig. Cooling capacity Puissance Frig. (W A -10°C)	370	687	687	951	951
Consumo Consumption Consommation (kWh/ 24h)	-				
Refrigerante Refrigerant Gaz	<b>R-290</b>				
Opcional Optional Options	<b>Puertas correderas traseras / Rear sliding doors / Portes coulissantes arrière</b>  VGL 9 [KPUVGL9P+] VGL 12 [KPUVGL12P+] VGL 15 [KPUVGL15P+] VGL 18 [KPUVGL18P+] VGL 25 [KPUVGL25P+]				

Serie / Series / Série **GLACE**

+Info: [www.infrico.com](http://www.infrico.com)



**Laterales / Sides / Jous**

**Incluidos / Includes / Inclus**

**Ext. Estándar / Standar / Standard**

Ral 9016	Ral 1001	Ral 1018
Ral 2003	Ral 3003	Ral 3020
Ral 4007	Design 3504035	Ral 5015
Design 1107060	Ral 6002	Design 2108025
Ral 8017	Ral 9006	Ral 7016
Nogal-Walnut-Noyer	Wengué-Wenge-Wenge	Ral 9017

**Colores fuera de carta / Colors outside of letter / Couleurs spéciales, hors palette**

RAL		NO RAL	
Epoxi	Líquida/ Liquid/ Liquide	Epoxi	Líquida/ Liquid/ Liquide
[x unidad/x unit/x unité]		Consultar / Consulter / Consulter	
+10 días laborables / +10 work days / +10 jours ouvrés		Consultar / Consulter / Consulter	

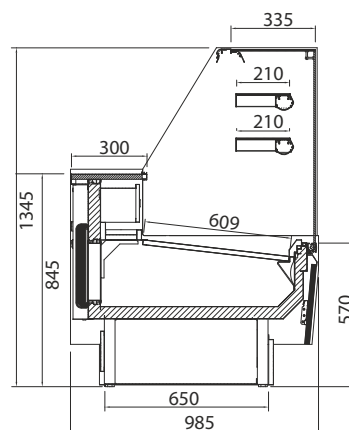

VGLP

**Muebles caja /**  
Counter case /  
Meuble caisse

Serie / Series / Série **GLACE**

MODELO MODELE MODÈLE	 <b>VGL 9 M</b>	 <b>VGL 15 M</b>	 <b>VGL 90 AAM</b>	 <b>VGL 90 ACM</b>
<b>Precio</b> Price Prix				
<b>Medidas</b> Measures Mesures	998 x 985 x 863 mm.	1622 x 985 x 863 mm.	1205 x 1140 x 863 mm.	1045 x 766 x 863 mm.



**Laterales / Sides / Joues**

**Incluidos / Includes / Inclus**

**Ext. Estándar / Standar / Standard**

Ral 9016	Ral 1001	Ral 1018
Ral 2003	Ral 3003	Ral 3020
Ral 4007	Design 3504035	Ral 5015
Design 1107060	Ral 6002	Design 2108025
Ral 8017	Ral 9006	Ral 7016
Nogel-Walnut-Noyer	Wengé-Wenge-Wenge	Ral 9017



**Colores fuera de carta /**  
Colors outside of letter /  
Couleurs spéciales, hors palette

RAL		NO RAL	
Epoxi	Líquida/ Liquid/ Liquide	Epoxi	Líquida/ Liquid/ Liquide
[x unidad/x unit/x unité]		Consultar / Consultar / Consultar	
+10 días laborables / +10 work days / +10 jours ouvrés		Consultar / Consultar / Consultar	

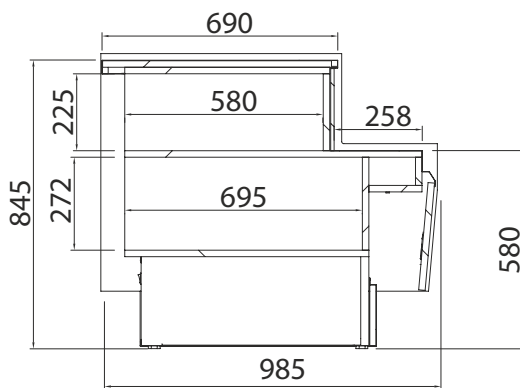

VGL M





VGL15M



Info: [www.infrico.com](http://www.infrico.com)



# Vitrina expositora para pastelería / Pastry display case / Vitrine d'exposition pour pâtisserie

MODELO MODELE MODÈLE						
Precio Price Prix	<b>VNZ</b>					
	<b>VNZ I</b>					
MOD.	<b>VNZ 9 DT / IDT</b>	<b>DOBLE TEMPERATURA / DOUBLE TEMPERATURE / DOUBLE TEMPÉRATURE</b>				
Precio Price Prix	<b>DT</b>					
	<b>IDT</b>					
MOD.	<b>VNZ 9 HT / IHT</b>	<b>CALIENTE / HOT / CHAUD</b>				
Precio Price Prix	<b>HT</b>					
	<b>IHT</b>					
Medidas Measures Mesures	(mm)	978 x 915 x 1040mm.	1290 x 915 x 1040 mm.	1602 x 915 x 1040 mm.	1915 x 915 x 1040 mm.	1290 x 915 x 1040 mm.
Temperatura Temperature Température	(°C)	<b>VNZ: +4°C/+8°C    DT: +4°C/+8°C +40°C/+50°C    HT: +40°C/+50°C</b>				
Clase Climática Climatic class Classe climatique	(°C)	3 / 25°C				
Tensión/Frecuencia Electrical data Tension électrique		230V/1ph/50Hz				
Controlador Controller Régulateur		Digital				
Material Matériel	[EXT/INT]	Acero plastificado / Plastified galvanised steel / Acier galvanisé plastifié Plano exposición / Exhibition plan / Plan d'exposition: Inox Aisi 304				
Aislamiento Isolation Isolation	(mm)	40kg/m <sup>3</sup> / Free CFC's / Zero ODP-GWP				
Capacidad Capacity Capacité	(L)	72	96	120	144	96
Superficie exposición Surface exhibition Surface d'exposition	(m <sup>2</sup> )	0,60	0,80	1,00	1,20	0,80
Compresor Compressor Compresseur	(HP)	1/4		1/3		1/4
Estantes Shelving Étagères		-				
Costados (2) Sides (2) Joues (2)	(mm)	20+20 <b>(INCLUIDOS / INCLUDES / INCLUS)</b>				
Sistema de frío Cooling System Système de froid		Ventilado / Ventilated / Ventilé				
Desescarche Defrost Dégivrage		Automático / Automatic / Automatique				
Evaporación Evaporation Évaporation		Semiestática / Semistatic / Semiestatique				
Potencia Power Puissance	(W)	<b>VNZ / DT:</b> 245 <b>HT:</b> 380	<b>VNZ / DT:</b> 262 <b>HT:</b> 510	<b>VNZ / DT:</b> 448 <b>HT:</b> 635	<b>VNZ / DT:</b> 454 <b>HT:</b> 760	650
Potencia frig. Cooling capacity Puissance Frig.	(W A -10°C)	-				
Consumo Consumption Consommation	(kWh/ 24h)	<b>VNZ</b> 4,2 <b>DT:</b> 7,7,4 <b>HT:</b> 7,4	<b>VNZ</b> 5,5 <b>DT:</b> 5,8/9,9 <b>HT:</b> 9,9	<b>VNZ</b> 7,6 <b>DT:</b> 8,2/12,4 <b>HT:</b> 12,4	<b>VNZ</b> 9,8 <b>DT:</b> 9,3/14,8 <b>HT:</b> 14,8	6,1
Refrigerante Refrigerant Gaz		<b>R-290</b>				
Opcional Optional Options		-				

Serie / Series / Série **NIZA**

+Info: [www.infrico.com](http://www.infrico.com)

VNZ 12HT + VNZ 15HT



**Laterales / Sides / Joues**

**Incluidos / Includes / Inclus**

**Ext. Estándar / Standar / Standard**

Ral 9016	Ral 1001	Ral 1018
Ral 2003	Ral 3003	Ral 3020
Ral 4007	Design 3504035	Ral 5015
Design 1107060	Ral 6002	Design 2108025
Ral 8017	Ral 9006	Ral 7016
Ral 9017		

VNZ 12 + VNZ 15

**Colores fuera de carta / Colors outside of letter / Couleurs spéciales, hors palette**

RAL		NO RAL	
Epoxi	Líquida/ Liquid/ Liquide	Epoxi	Líquida/ Liquid/ Liquide
		Consultar / Consultar / Consulter	
[x unidad/x unit/x unité]			
+10 días laborables / +10 work days / +10 jours ouvrés		Consultar / Consultar / Consulter	

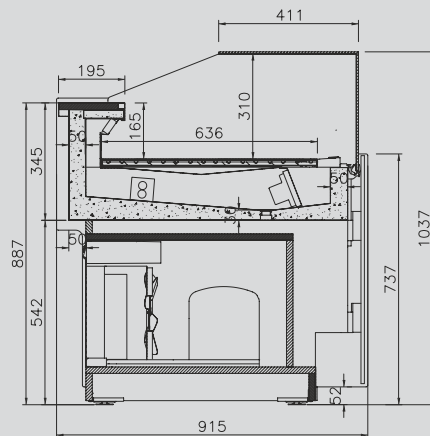







VNZ



**Muebles caja /**  
Counter case /  
Meuble caisse

Serie / Series / Série **NIZA**

MODELO MODELE MODÈLE							
	VNZ 9 M	VNZ 12 M	VNZ 12 MHD	VNZ 90 AAM	VNZ 45 AAM	VNZ 90 ACM	VNZ 45 ACM
Precio Price Prix							
Medidas/Measures/ Mesures [mm] Sin costados/Without sides/Sans joues	998 x 915 x 740 mm.	1290 x 915 x 740 mm.	1290 x 915 x 740 mm.	1855 x 915 x 740 mm.	1035 x 915 x 740 mm.	2325 x 915 x 740 mm.	1295 x 915 x 740 mm.

VNZ90AAM



**Laterales / Sides / Joues**

**Incluidos / Includes / Inclus**

**Ext. Estándar / Standar / Standard**

Ral 9016	Ral 1001	Ral 1018
Ral 2003	Ral 3003	Ral 3020
Ral 4007	Design 3504035	Ral 5015
Design 1107060	Ral 6002	Design 2108025
Ral 8017	Ral 9006	Ral 7016
Ral 9017		

**Colores fuera de carta /**  
Colors outside of letter /  
Couleurs spéciales, hors palette

RAL		NO RAL	
Epoxi	Líquida/ Liquid/ Liquide	Epoxi	Líquida/ Liquid/ Liquide
[x unidad/x unit/x unité]		Consultar / Consulter / Consulter	
+10 días laborables / +10 work days / +10 jours ouvrés		Consultar / Consulter / Consulter	





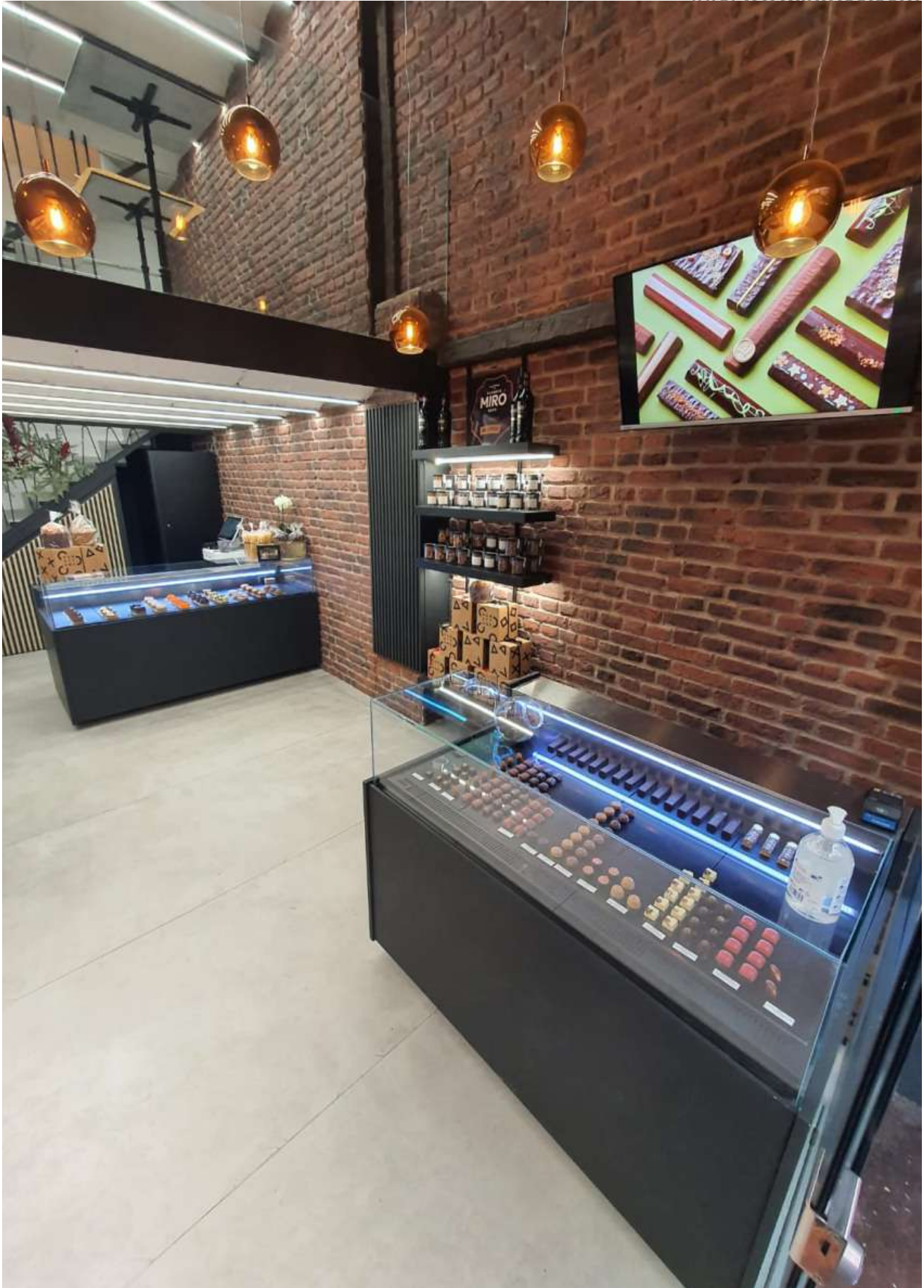

VNZ12M

+Info: [www.infrico.com](http://www.infrico.com)



# Vitrina expositora para pastelería / Pastry display case / Vitrine d'exposition pour pâtisserie

MODELO MODELE MODÈLE	 VLY 9	 VLY 12	 VLY 15	 VLY 18	 VLY 25
Precio Price Prix					
	<b>VLY 9I</b>	<b>VLY 12I</b>	<b>VLY 15I</b>	<b>VLY 18I</b>	<b>VLY 25I</b>
Precio Price Prix					
Medidas/Measures/ Mesures [mm] Sin costados/Without sides/Sans joues	938 x 900 x 1305 mm.	1250 x 900 x 1305 mm.	1562 x 905 x 1305 mm.	1875 x 905 x 1305 mm.	2500 x 905 x 1305 mm.
Temperatura Temperature [°C] Température	4°C/+8°C				
Clase Climática Climatic class [°C] Classe climatique	3 / 25°C				
Tensión/Frecuencia Electrical data Tension électrique	230V/1ph/50Hz				
Controlador Controller Régulateur	Digital				
Material Material [EXT/INT] Matériel	Ext: acero plastificado / Plastified stainless steel / Acier plastifié Encimera / Worktop / Dessous: Inox Aisi 304 Plano exposición / Exhibition plan / Plan d'exposition: Acero plastif.negro/ Plastif. Stainless steel black/ Acier plastifié noire [Mod. VLY] - Inox Aisi 304 [Mod. I]				
Aislamiento Isolation [mm] Isolation	40kg/m <sup>3</sup> / Free CFC's / Zero ODP-GWP				
Capacidad Capacity [L] Capacité	72	96	120	144	192
Superficie exposición Surface exhibition [m <sup>2</sup> ] Surface d'exposition	0,60	0,80	1,00	1,20	1,60
Compresor Compressor [HP] Compresseur	1/4		1/3		1/2
Bandejas Trays (300x400) Bacs (600x400)	-				
Costados [2] Sides [2] [mm] Joues [2]	30+30 <b>(NO INCLUIDOS / NOT INCLUDED / NON INCLUES)</b>				
Sistema de frío Cooling System Système de froid	Ventilado / Ventilated / Ventilé				
Desescarche Defrost Dégivrage	Manual / Manual / Manuel				
Evaporación Evaporation Évaporation	Semiestática / Semistatic / Semiestatique				
Potencia Power [W] Puissance	245	262	448	454	588
Potencia frig. Cooling capacity [W A -10°C] Puissance Frig.	-				
Consumo Consumption [kWh/ 24h] Consommation	4.2	5.5	7.6	9,8	10.3
Refrigerante Refrigerant Gaz	R-290				
Opcional Optional Options	Puertas correderas traseras / Rear sliding doors / Portes coulissantes arrière				
	(PUEVLY9CT)	(PUEVLY12CT)	(PUEVLY15CT)	(PUEVLY18CT)	(PUEVLY25CT)
	Estantes / Shelving / Étagères				
	(ESTVCB9)	(ESTVCB12)	(ESTVCB15)	(ESTVCB18)	(ESTVCB25)

**Laterales no incluidos en el precio**  
Side panels not included in price  
Joues non incluses dans le prix

Serie / Series / Série **LYON**

+Info: [www.infrico.com](http://www.infrico.com)

VLY15



**Laterales no incluidos en el precio**  
Side panels not included in price  
Joues non incluses dans le prix

**Laterales / Sides / Joues**

NO	
Izquierdo Left Gauche	Derecho Right Droite

**Ext. Estándar / Standar / Standard**

Ral 9016	Ral 1001	Ral 1018
Ral 2003	Ral 3003	Ral 3020
Ral 4007	Design 3504035	Ral 5015
Design 1107060	Ral 6002	Design 2108025
Ral 8017	Ral 9006	Ral 7016
Ral 9017		

**Colores fuera de carta /**  
Colors outside of letter /  
Couleurs spéciales, hors palette

RAL		NO RAL	
Epoxi	Líquida/ Liquid/ Liquide	Epoxi	Líquida/ Liquid/ Liquide
(x unidad/x unit/x unité)		Consultar / Consulter / Consulter	
+10 días laborables / +10 work days / +10 jours ouvrés		Consultar / Consulter / Consulter	





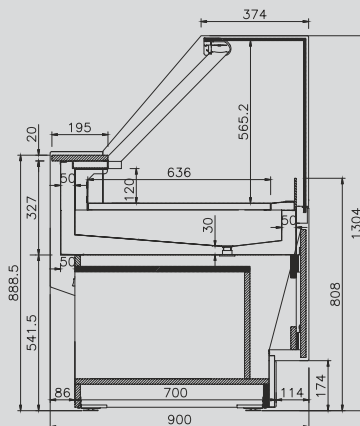

VLY9



VLY

# Vitrina expositora para pastelería / Pastry display case / Vitrine d'exposition pour pâtisserie

MODELO MODELE MODÈLE	VIENNOISERIE (NEUTRA/NEUTRAL/NEUTRE)		CHOCOLATE / CHOCOLAT	BAIN MARIE (CALIENTE/HOT/CHAUD)	
	 VLY 9 V	 VLY 12 V	 VLY 12 B / VLY 12 IB	 VLY 12 BMS	 VLY 15 BMS
Precio Price Prix					
Medidas/Measures/ Mesures [mm] Sin costados/Without sides/Sans joues	938 x 900 x 1550 mm.	1250 x 900 x 1550 mm.	1250 x 900 x 1060 mm.	1250 x 900 x 1305 mm.	1562 x 900 x 1305 mm.
Temperatura Temperature [°C] Température	-		+7°C/+12°C	+60°C/+70°C	
Clase Climática Climatic class [°C] Classe climatique	3 / 25°C				
Tensión/Frecuencia Electrical data Tension électrique	230V/1ph/50Hz				
Controlador Controller Régulateur	Digital				
Material Matériel [EXT/INT]	Ext: acero plastificado / Plastified stainless steel / Acier plastifié Encimera / Worktop / Dessous: Inox Aisi 304 Plano exposición / Exhibition plan / Plan d'exposition: Acero plastif./ Plastif. Stainless steel/ Acier plastifié (Mod. V/B/BMS) - Inox Aisi 304 (Mod. I)				
Aislamiento Isolation [mm]	40kg/m <sup>3</sup> / Free CFC's / Zero ODP-GWP				
Capacidad Capacity [L] Capacité	184	245	96	78	163
Superficie exposición Surface exhibition [m <sup>2</sup> ] Surface d'exposition	1,13	1,50	0,80	0,69	0,86
Compresor Compressor [HP] Compresseur	-	-	1/5	-	-
Bandejas Trays (300x400) Bacs (600x400)		-		3	4
Costados [2] Sides [2] [mm] Joues [2]	30+30				
Sistema de frío Cooling System Système de froid	Ventilado / Ventilated / Ventilé				
Desescarche Defrost Dégivrage	Manual / Manual / Manuel				
Evaporación Evaporation Évaporation	Semiestática / Semistatic / Semiestatique				
Potencia Power [W] Puissance	45	70	795	2050	3050
Potencia frig. Cooling capacity [W A -10°C] Puissance Frig.	-	-	254	-	-
Consumo Consumption [kWh/ 24h] Consommation	0,6	1	6,1	12,3	18,3
Refrigerante Refrigerant Gaz	R-290				
Opcional Optional Options	-		Puertas correderas traseras / Rear sliding doors / Portes coulissantes arrière [PUEVLY12CTB]	-	

Laterales no incluidos en el precio  
Side panels not included in price  
Joues non incluses dans le prix



Serie / Series / Série **LYON VIENNOISERIE**  
 Serie / Series / Série **LYON CHOCOLATE/CHOCOLAT**  
 Serie / Series / Série **LYON BAIN MARIE**

+Info: [www.infrico.com](http://www.infrico.com)

**Vitrina Baño María para servicio de comida caliente**  
 Display case Bain Marie for food service  
 Vitrine Bain Marie pour plats chauds

VLY12BMS



VLY12B

**Vitrina para venta de chocolates**  
 Display case for chocolate sale  
 Vitrine pour la vente de chocolats



**Puertas correderas traseras de serie**  
 Rear sliding doors standard  
 Portes coulissantes arrières à série

Laterales / Sides / Joes

**VLY V/BMS**  
 Incluidos / Includes / Inclus

Laterales / Sides / Joes

NO INCLUIDOS VLY B	
Izquierdo Left Gauche	Derecho Right Droite



Neutro  
Neutral  
Neutre

**3 estantes de serie**  
 3 shelves standard  
 3 étagères à série

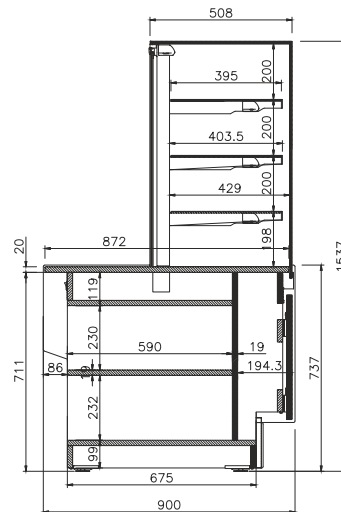

Ext. Estándar / Standar / Standard

Ral 9016	Ral 1001	Ral 1018
Ral 2003	Ral 3003	Ral 3020
Ral 4007	Design 3504035	Ral 5015
Design 1107060	Ral 6002	Design 2108025
Ral 8017	Ral 9006	Ral 7016
Ral 9017		

**Colores fuera de carta /**  
 Colors outside of letter /  
 Couleurs spéciales, hors palette

RAL	NO RAL
Epoxi	Líquida/ Liquid/ Liquide
	Epoxi
	Líquida/ Liquid/ Liquide
	Consultar / Consultar / Consultar
(x unidad/x unit/x unité)	
+10 días laborables / +10 work days / +10 jours ouvrés	Consultar / Consultar / Consultar

VLY9V

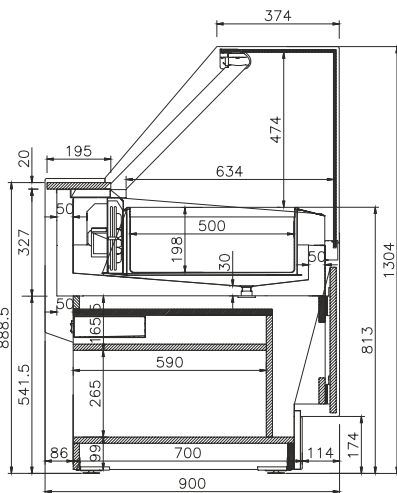



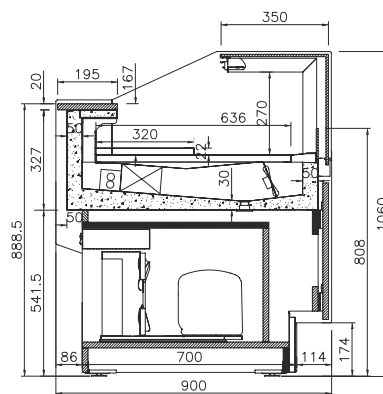

VLY BMS

VLY V



VLY B

# Vitrina expositora para pastelería cristal bajo / Pastry display case low glass / Vitrine d'exposition pour pâtisserie vitre basse

MODELO MODELE MODÈLE					
Precio Price Prix					
	VLY 9 ILG	VLY 12 ILG	VLY 15 ILG	VLY 18 ILG	VLY 25 ILG
Precio Price Prix					
Medidas/Measures/ Mesures/Without sides/Sans joues (mm)	938 x 900 x 1060 mm.	1250 x 900 x 1060 mm.	1562 x 900 x 1060 mm.	1875 x 900 x 1060 mm.	2500 x 900 x 1060 mm.
Temperatura Temperature (°C) Température	<b>+4°C/+8°C</b>				
Clase Climática Climatic class (°C) Classe climatique	3 / 25°C				
Tensión/Frecuencia Electrical data Tension électrique	230V/1ph/50Hz				
Controlador Controller Régulateur	Digital				
Material Material (EXT/INT) Matériel	Ext: acero plastificado / Plastified stainless steel / Acier plastifié Encimera / Worktop / Dessous: Inox Aisi 304 Plano exposición / Exhibition plan / Plan d'exposition: Acero plastif. negro/ Plastif. Stainless steel black / Acier plastifié noire (Mod. LG) - Inox Aisi 304 (Mod. I)				
Aislamiento Isolation (mm) Isolation	40kg/m <sup>3</sup> / Free CFC's / Zero ODP-GWP				
Capacidad Capacity (L) Capacité	72	96	120	144	192
Superficie exposición Surface exhibition (m <sup>2</sup> ) Surface d'exposition					
Compresor Compressor (HP) Compresseur	1/4		1/3		1/2
Bandejas Trays (300x400) Bacs (600x400)	-				
Costados [2] Sides [2] (mm) Joues [2]	30+30 <b>(NO INCLUIDOS / NOT INCLUDED / NON INCLUES)</b>				
Sistema de frío Cooling System Système de froid	Ventilado / Ventilated / Ventilé				
Desescarche Defrost Dégivrage	Manual / Manual / Manuel				
Evaporación Evaporation Évaporation	Semiestática / Semistatic / Semiestatique				
Potencia Power (W) Puissance	245	262	448	454	588
Potencia frig. Cooling capacity (W A -10°C) Puissance Frig.	-				
Consumo Consumption (kWh/ 24h) Consommation	4.2	5.5	7.6	9,8	10.3
Refrigerante Refrigerant Gaz	<b>R-290</b>				
Opcional Optional Options	Puertas correderas traseras / Rear sliding doors / Portes coulissantes arrière (PUEVLY9CTB)	Puertas correderas traseras / Rear sliding doors / Portes coulissantes arrière (PUEVLY12CTB)	Puertas correderas traseras / Rear sliding doors / Portes coulissantes arrière (PUEVLY15CTB)	Puertas correderas traseras / Rear sliding doors / Portes coulissantes arrière (PUEVLY18CTB)	Puertas correderas traseras / Rear sliding doors / Portes coulissantes arrière (PUEVLY25CTB)

**Laterales no incluidos en el precio**  
Side panels not included in price  
Joues non incluses dans le prix

Serie / Series / Série **LYON LG**

+Info: [www.infrico.com](http://www.infrico.com)

VLY15LG



**Laterales / Sides / Jous**

**NO INCLUIDOS**

Izquierdo Left Gauche	Derecho Right Droite
-----------------------------	----------------------------

**Ext. Estándar / Standar / Standard**

Ral 9016	Ral 1001	Ral 1018
Ral 2003	Ral 3003	Ral 3020
Ral 4007	Design 3504035	Ral 5015
Design 1107060	Ral 6002	Design 2108025
Ral 8017	Ral 9006	Ral 7016
Ral 9017		



VLY12LG

**Colores fuera de carta /  
Colors outside of letter /  
Couleurs spéciales, hors palette**



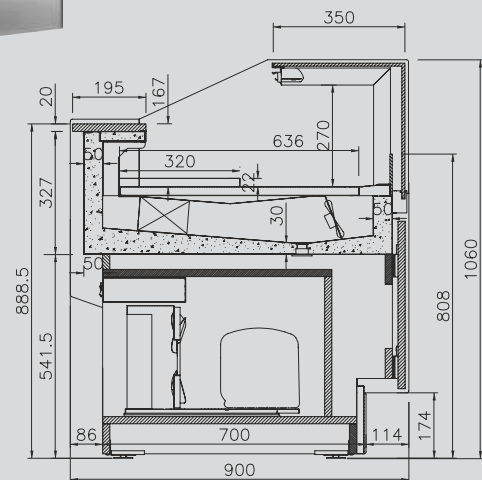



RAL		NO RAL	
Epoxi	Líquida/ Liquid/ Liquide	Epoxi	Líquida/ Liquid/ Liquide
[x unidad/x unit/x unité]		Consultar / Consultar / Consultar	
+10 días laborables / +10 work days / +10 jours ouvrés		Consultar / Consultar / Consultar	



VLY LG

**Muebles caja /**  
Counter case /  
Meuble caisse

Serie / Series / Série **LYON**

MODELO MODELE MODÈLE							
<b>Precio</b> Price Prix							
<b>Medidas/Measures/</b> Mesures [mm] <b>Sin costados/Without</b> sides/Sans joues	938 x 900 x 745 mm.	1250 x 900 x 745 mm.	1250 x 900 x 745 mm.	1035 x 900 x 745 mm.	1855 x 900 x 745 mm.	1295 x 900 x 745 mm.	2325 x 900 x 745 mm.

VLY12MHD



HANDICAPÉ

**Laterales/ Sides / Joues**

**Incluidos / Includes / Inclus**

**Ext. Estándar / Standar / Standard**

Ral 9016	Ral 1001	Ral 1018
Ral 2003	Ral 3003	Ral 3020
Ral 4007	Design 3504035	Ral 5015
Design 1107060	Ral 6002	Design 2108025
Ral 8017	Ral 9006	Ral 7016
Ral 9017		

**Colores fuera de carta /**  
Colors outside of letter /  
Couleurs spéciales, hors palette

RAL		NO RAL	
Epoxi	Líquida/ Liquid/ Liquide	Epoxi	Líquida/ Liquid/ Liquide
[x unidad/x unit/x unité]		Consultar / Consulter / Consulter	
+10 días laborables / +10 work days / +10 jours ouvrés		Consultar / Consulter / Consulter	



VLY9M

+Info: [www.infrico.com](http://www.infrico.com)



Los datos técnicos están sujetos a posibles variaciones que serán actualizadas periódicamente en las fichas técnicas del producto, disponibles en la web /  
The technical data are subject to possible variations that will be updated periodically in the technical data sheets of the product, which are available on the website /  
Les données techniques peuvent varier et seront actualisées dans les fiches techniques du produit, disponibles sur le site web.

# Serie Ámbar



VBR12PC

+Info: [www.infrico.com](http://www.infrico.com)







**VBR12PDS**

**VBR12PSS**

**VBR12PR**



# Vitrina expositora para pastelería / Pastry display case / Vitrine d'exposition pour pâtisserie

MODELO MODELE MODÈLE									
Precio Price Prix	R IR	-							
<b>REFRIGERADA / REFRIGERATED / RÉFRIGÉRÉ</b>									
MOD.			<b>VBR 9 R/IR</b>	<b>VBR 12 R/IR</b>	<b>VBR 18 R/IR</b>				
<b>CALIENTE / HOT / CHAUD</b>									
Precio Price Prix	HT IHT	-							
MOD.			<b>VBR 9 HT/IHT</b>	<b>VBR 12 HT/IHT</b>	<b>VBR 18 HT/IHT</b>				
<b>AUTOSERVICIO / SELF SERVICE / LIBRE SERVICE</b>									
Precio Price Prix	SS ISS								
MOD.		<b>VBR 6 SS/ISS</b>	<b>VBR 9 SS/ISS</b>	<b>VBR 12 SS/ISS</b>	<b>VBR 18 SS/ISS</b>				
<b>DOBLE SERVICIO / DOUBLE SERVICE / DOUBLE SERVICE</b>									
Precio Price Prix	DS IDS	-							
MOD.			<b>VBR 9 DS/IDS</b>	<b>VBR 12 DS/IDS</b>	<b>VBR 18 DS/IDS</b>				
Medidas/Measures/ Mesures [mm] Sin costados/Without sides/Sans joues		625 x 810 x 1300 mm.	938 x 810 x 1300 mm.	1250 x 810 x 1300 mm.	1875 x 810 x 1300 mm.				
Temperatura Temperature Température [°C]		<b>R / SS / DS: +4°C/+8°C HT: +55°C/+60°C</b>							
Clase Climática Climatic class Classe climatique [°C]		3 / 25°C							
Tensión/Frecuencia Electrical data Tension électrique		230V/1ph/50Hz							
Controlador Controller Régulateur		Digital							
Material Material Matériel [EXT/INT]		Ext: acero plastificado / Plastified steel / Acier plastifié Encimera / Worktop / Dessous: Inox Aisi 304 Plano exposición / Exhibition plan / Plan d'exposition: Acero plastif. negro/ Plastif. steel black/ Acier plastifié noire(R/HT/SS/DS) - Inox Aisi 304 (Mod. I)							
Aislamiento Isolation Isolation [mm]		40kg/m <sup>3</sup> / Free CFC's / Zero ODP-GWP							
Capacidad Capacity Capacité [L]		180	274	365	548				
Superficie exposición Surface exhibition Surface d'exposition [m <sup>2</sup> ]		0,9	1,4	1,9	2,8				
Compresor Compressor Compresseur [HP]		1/3	3/4	3/4 DS: 1	1 1/4				
Puertas / Estanterías Doors / Shelving Portes / Étagères		<b>R: - SS: - / 3</b>	<b>HT: - DS: -</b>	<b>R: 2 / 3 SS: - / 3</b>	<b>HT: 2 / 2 DS: 2 / 3</b>	<b>R: 2 / 3 SS: - / 3</b>	<b>HT: 2 / 2 DS: 2 / 3</b>	<b>R: 2 / 3 SS: - / 3</b>	<b>HT: 2 / 2 DS: 2 / 4</b>
Costados [2] Sides [2] Joues [2] [mm]		20+20 <b>(INCLUIDOS / INCLUDES / INCLUS)</b>							
Sistema de frío Cooling System Système de froid		Ventilado / Ventilated / Ventilé							
Desescarche Defrost Dégivrage		Automático / Automatic / Automatique							
Evaporación Evaporation Évaporation		Semiestática / Semistatic / Semiestatique							
Potencia Power Puissance [W]		<b>R: - SS: 404</b>	<b>HT: - DS: -</b>	<b>R: 708 SS: 708</b>	<b>HT: 1080 DS: 708</b>	<b>R: 722 SS: 722</b>	<b>HT: 1107 DS: 815</b>	<b>R: 1223 SS: 1223</b>	<b>HT: 1125 DS: 1223</b>
Potencia frig. Cooling capacity Puissance Frig. [W A -10°C]		750	1096	1315	2192				
Consumo Consumption Consommation [kWh/ 24h]		<b>R: - SS: 5.65</b>	<b>HT: - DS: -</b>	<b>R: 8.5 SS: 9.25</b>	<b>HT: 9.85 DS: 7.54</b>	<b>R: 9.7 SS: 9.49</b>	<b>HT: 10.4 DS: 9.95</b>	<b>R: 14.5 SS: 15.8</b>	<b>HT: 10.8 DS: 14.9</b>
Refrigerante Refrigerant Gaz		<b>R-290</b>							
Opcional Optional Options		<b>Cristal frontal doble / Double front glass / Double front glass</b> VBR 9 VBR 12 VBR 18							

**\*Este precio es aplicable cuando el cristal va incorporado en el mueble.**  
This price is applicable when the glass is incorporated with the display case.  
Prix applicable quand la vitre est livrée dans la vitrine



Serie / Series / Série **AMBAR**

+Info: [www.infrico.com](http://www.infrico.com)

VBR12HT



VBR12R



VBR6SS



VBR12DS

VBR SS/DS



VBR R/DS/HT



Laterales / Sides / Jous

Incluidos / Includes / Inclus

Ext. Estándar / Standar / Standard

Ral 9016	Ral 1001	Ral 1018
Ral 2003	Ral 3003	Ral 3020
Ral 4007	Design 3504035	Ral 5015
Design 1107060	Ral 6002	Design 2108025
Ral 8017	Ral 9006	Ral 7016
Nogal-Walnut-Noyer	Wengué-Wenge-Wenge	Ral 9017

Colores fuera de carta / Colors outside of letter / Couleurs spéciales, hors palette

RAL		NO RAL	
Epoxi	Líquida/Liquid/Liquide	Epoxi	Líquida/Liquid/Liquide
[x unidad/x unit/x unité]		Consultar / Consulter / Consulter	
+10 días laborables / +10 work days / +10 jours ouvrés		Consultar / Consulter / Consulter	

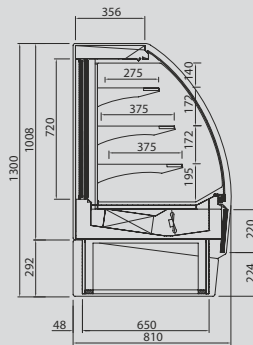

VBR R / DS

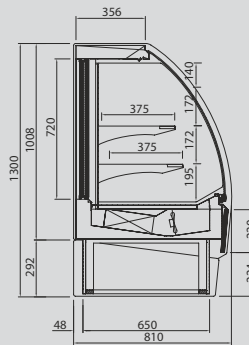



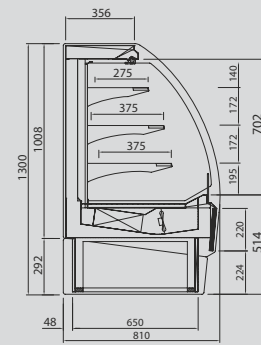

VBR HT



VBR SS



# Vitrina expositora para pastelería / Pastry display case / Vitrine d'exposition pour pâtisserie

MODELO MODELE MODÈLE					
Precio Price Prix	PR IPR				
			CALIENTE / HOT / CHAUD		
MOD.	VBR 9 PHT/IPHT	VBR 12 PHT/IPHT	VBR 18 PHT/IPHT	VBR 9 PC	VBR 12 PC
Precio Price Prix	PHT IPHT				
Medidas/Measures/ Mesures (mm) Sin costados/Without sides/Sans joues	938 x 810 x 1300 mm.	1250 x 810 x 1300 mm.	1875 x 810 x 1300 mm.	938 x 810 x 1300 mm.	1250 x 810 x 1300 mm.
Temperatura Temperature Température (°C)		PR: +4°C/+8°C PHT: +55°C/+60°C		+65°C	
Clase Climática Climatic class Classe climatique (°C)		3 / 25°C			
Tensión/Frecuencia Electrical data Tension électrique	230V/1ph/50Hz				
Controlador Controller Régulateur	Digital				
Material Matériel (EXT/INT)	Ext: acero plastificado / Plastified steel / Acier plastifié Encimera / Worktop / Dessous: Inox Aisi 304 Plano exposición / Exhibition plan / Plan d'exposition: Acero plastif./ Plastif. steel/ Acier plastifié (PR/PHT) - Inox Aisi 304 (Mod. I)				
Aislamiento Isolation Isolation (mm)	40kg/m <sup>3</sup> / Free CFC's / Zero ODP-GWP				
Capacidad Capacity Capacité (L)	274	365	548	274	365
Superficie exposición Surface exhibition Surface d'exposition (m <sup>2</sup> )	1,4	1,9	2,8	1	1,4
Compresor Compressor Compresseur (HP)	3/4	3/4	1 1/4		
Puertas / Estantes Doors / Shelving Portes / Étagères	R: 2 / 3 HT: 2 / 2	R: 2 / 3 HT: 2 / 2	R: 2 / 3 HT: 2 / 2	2 / 2	
Costados [2] Sides [2] Joues [2] (mm)	20+20 (INCLUIDOS / INCLUDES / INCLUS)				
Sistema de frío Cooling System Système de froid	Ventilado / Ventilated / Ventilé				
Desescarche Defrost Dégivrage	Manual / Manual / Manuel				
Evaporación Evaporation Évaporation	Semiestática / Semistatic / Semiestatique				
Potencia Power Puissance (W)	R: 708 HT: 1080	R: 722 HT: 1107	R: 1223 HT: 1125	3500	4670
Potencia frig. Cooling capacity Puissance Frig. (W A -10°C)	1096	1315	2192		
Consumo Consumption Consommation (kWh/ 24h)	R: 8.5 HT: 9.85	R: 9.7 HT: 10,4	R: 14.5 HT: 10.8	42	56
Refrigerante Refrigerant Gaz	R-290				
Opcional Optional Options	-				

# NEW

## Serie / Series / Série AMBAR

+Info: [www.infrico.com](http://www.infrico.com)

VBR12PR



VBR12PHT



**Posibilidad de intercalar módulo Self Service [consultar]**  
**Possibility of adding a Self-Service module [contact us]**  
**Possibilité d'intercaler le module Self Service [nous contacter]**

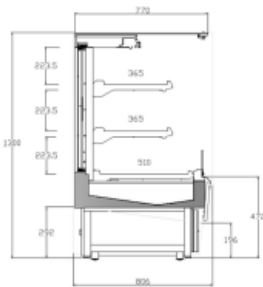

VBR PC

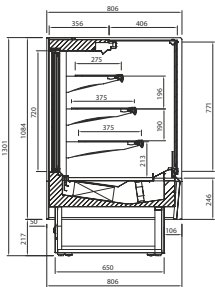

VBR PR

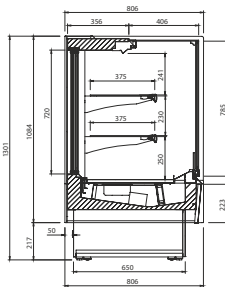

VBR PHT

VBR9PC



**Laterales / Sides / Jous**

**Incluidos / Includes / Inclus**

**Ext. Estándar / Standar / Standard**

Ral 9016	Ral 1001	Ral 1018
Ral 2003	Ral 3003	Ral 3020
Ral 4007	Design 3504035	Ral 5015
Design 1107060	Ral 6002	Design 2108025
Ral 8017	Ral 9006	Ral 7016
Nogal-Walnut-Noyer	Wengué-Wenge-Wenge	Ral 9017







**Colores fuera de carta / Colors outside of letter / Couleurs spéciales, hors palette**

RAL		NO RAL	
Epoxi	Líquida/Liquid/Liquide	Epoxi	Líquida/Liquid/Liquide
[x unidad/x unit/x unité]		Consultar / Consulter / Consulter	
+10 días laborables / +10 work days / +10 jours ouvrés		Consultar / Consulter / Consulter	



Los datos técnicos están sujetos a posibles variaciones que serán actualizadas periódicamente en las fichas técnicas del producto, disponibles en la web / The technical data are subject to possible variations that will be updated periodically in the technical data sheets of the product, which are available on the website / Les données techniques peuvent varier et seront actualisées dans les fiches techniques du produit, disponibles sur le site web.

# Vitrina expositora para pastelería / Pastry display case / Vitrine d'exposition pour pâtisserie

		VBR PSS / IPSS				VBR PDS / IPDS		
MODELO MODELE MODÈLE								
Precio Price Prix	PR IPR							
		INOX						
MOD.		VBR 6 IPSS	VBR 9 IPSS	VBR 12 IPSS	VBR 18 IPSS	VBR 9 IPDS	VBR 12 IPDS	VBR 18 IPDS
Precio Price Prix	PHT IPHT							
Medidas/Measures/ Mesures [mm] Sin costados/Without sides/Sans joues		625 x 810 x 1300 mm.	938 x 810 x 1300 mm.	1250 x 810 x 1300 mm.	1875 x 810 x 1300 mm.	938 x 810 x 1300 mm.	1250 x 810 x 1300 mm.	1875 x 810 x 1300 mm.
Temperatura Temperature Température	[°C]	-1°C/+7°C						
Clase Climática Climatic class Classe climatique	[°C]	3 / 25°C						
Tensión/Frecuencia Electrical data Tension électrique		230V/1ph/50Hz						
Controlador Controller Régulateur		Digital						
Material Matériel	[EXT/INT]	Ext: acero plastificado / Plastified steel / Acier plastifié Encimera / Worktop / Dessous: Inox Aisi 304 Plano exposición / Exhibition plan / Plan d'exposition: Acero plastif./ Plastif. steel/ Acier plastifié [PR/PHT] - Inox Aisi 304 [Mod. I]						
Aislamiento Isolation Isolation	[mm]	40kg/m <sup>3</sup> / Free CFC's / Zero ODP-GWP						
Capacidad Capacity Capacité	[L]	176	264	352	528	262	349	523
Superficie exposición Surface exhibition Surface d'exposition	[m <sup>2</sup> ]	1	1,4	1,9	2,8	1	1,4	2,8
Compresor Compressor Compresseur	[HP]	1/2	3/4	3/4	1/2	3/4	1	1/2
Puertas / Estantes Doors / Shelving Portes / Étagères		0 / 3				2 / 3		3 / 3
Costados [2] Sides [2] Joues [2]	[mm]	20+20 (INCLUIDOS / INCLUDES / INCLUS)						
Sistema de frío Cooling System Système de froid		Ventilado / Ventilated / Ventilé						
Desescarche Defrost Dégivrage		Manual / Manual / Manuel						
Evaporación Evaporation Évaporation		Ventilado / Ventilated / Ventilé						
Potencia Power Puissance	[W]	523	709	724	1225	708	815	1223
Potencia frig. Cooling capacity Puissance Frig.	[W A -10°C]	850	1453	1453	2328	1453	1706	2328
Consumo Consumption Consommation	[kWh/ 24h]	6.84	9.28	9.47	14.7	7.54	9.95	14.91
Refrigerante Refrigerant Gaz		R-290						
Opcional Optional Options		-						

# NEW

## Serie / Series / Série AMBAR

+Info: [www.infrico.com](http://www.infrico.com)

### VBR12PSS

Laterales / Sides / Jous

Incluidos / Includes / Inclus

Ext. Estándar / Standar / Standard

Ral 9016	Ral 1001	Ral 1018
Ral 2003	Ral 3003	Ral 3020
Ral 4007	Design 3504035	Ral 5015
Design 1107060	Ral 6002	Design 2108025
Ral 8017	Ral 9006	Ral 7016
Nogal-Walnut-Noyer	Wengué-Wenge-Wenge	Ral 9017

Colores fuera de carta /  
Colors outside of letter /  
Couleurs spéciales, hors palette



RAL		NO RAL	
Epoxi	Líquida/ Liquid/ Liquide	Epoxi	Líquida/ Liquid/ Liquide
[x unidad/x unit/x unité]		Consultar / Consultar / Consultar	
+10 días laborables / +10 work days / +10 jours ouvrés		Consultar / Consultar / Consultar	

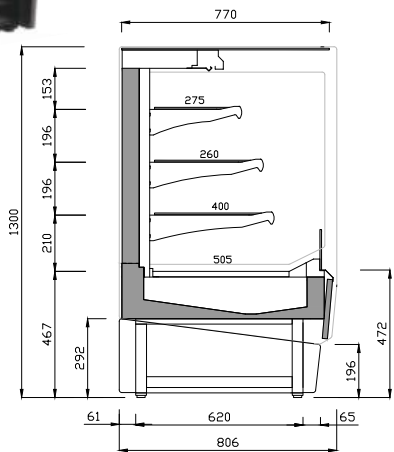

### VBRPSS



# Vitrina expositora para pastelería / Pastry display case / Vitrine d'exposition pour pâtisserie

MODELO MODELE MODÈLE			
Precio Price Prix			
		<b>CALIENTE / HOT / CHAUD</b>	
MOD.	<b>VON 9 PHT</b>	<b>VON 12 PHT</b>	<b>VON 18 PHT</b>
Precio Price Prix			
Medidas/Measures/ Mesures (mm) Sin costados/Without sides/Sans joues	938 x 810 x 1300 mm.	1250 x 810 x 1300 mm.	1875 x 810 x 1300 mm.
Temperatura Temperature (°C) Température	<b>PR: +4°C/+8°C</b> <b>PHT: +55°C/+60°C</b>		
Clase Climática Climatic class (°C) Classe climatique	3 / 25°C		
Tensión/Frecuencia Electrical data Tension électrique	230V/1ph/50Hz		
Controlador Controller Régulateur	Digital		
Material Material [EXT/INT] Matériel	Aisi 304		
Aislamiento Isolation (mm) Isolation	40kg/m <sup>3</sup> / Free CFC's / Zero ODP-GWP		
Capacidad Capacity (L) Capacité	274	365	548
Superficie exposición Surface exhibition (m <sup>2</sup> ) Surface d'exposition	1,4	1,9	2,8
Compresor Compressor (HP) Compresseur	1/2	3/4	1 1/4
Puertas / Estantes Doors / Shelving Portes / Étagères	<b>PR: 2 / 3</b> <b>PHT: 2 / 2</b>	<b>PR: 2 / 3</b> <b>PHT: 2 / 3</b>	<b>PR: 3 / 3</b> <b>PHT: 3 / 2</b>
Costados (2) Sides (2) (mm) Joues (2)	<b>20+20 (INCLUIDOS / INCLUDES / INCLUS)</b>		
Sistema de frío Cooling System Système de froid	Ventilado / Ventilated / Ventilé		
Desescarche Defrost Dégivrage	Manual / Manual / Manuel		
Evaporación Evaporation Évaporation	Semiestática / Semistatic / Semiestatique		
Potencia Power (W) Puissance	<b>PR: 708</b> <b>HT: 1080</b>	<b>PR: 722</b> <b>HT: 1107</b>	<b>PR: 1223</b> <b>HT: 1125</b>
Potencia frig. Cooling capacity (W A -10°C) Puissance Frig.	1096	1315	1840
Consumo Consumption (kWh/ 24h) Consommation	<b>PR: 8.5</b> <b>HT: 9.85</b>	<b>PR: 9.7</b> <b>HT: 10,4</b>	<b>PR: 14.5</b> <b>HT: 10.8</b>
Refrigerante Refrigerant Gaz	<b>R-290</b>		
Opcional Optional Options	-		

Serie / Series / Série **ONIX**

+Info: [www.infrico.com](http://www.infrico.com)

VON12PR



VON12PHT



Laterales / Sides / Joues  
Incluidos / Includes / Inclus

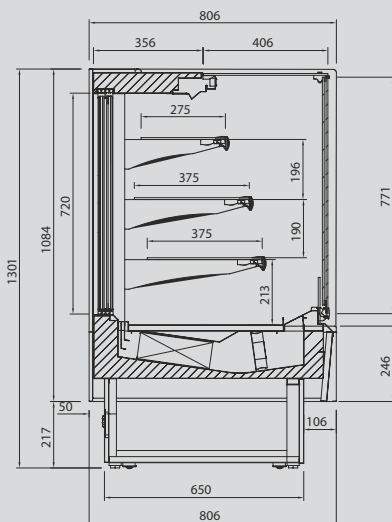



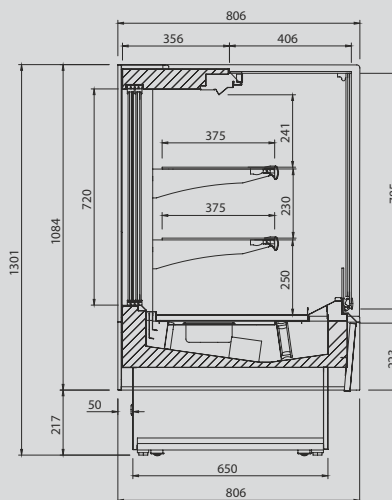

VON PR



VON PHT



# Vitrina expositora para pastelería / Pastry display case / Vitrine d'exposition pour pâtisserie

MODELO MODELE MODÈLE				
Precio Price Prix	-			
MOD.	-	CALIENTE / HOT / CHAUD VON 9 HT		VON 12 HT
Precio Price Prix	-			
MOD.	AUTOSERVICIO / SELF SERVICE / LIBRE SERVICE VON 6 SS			
Precio Price Prix				
MOD.	DOBLE SERVICIO / DOUBLE SERVICE / DOUBLE SERVICE VON 9 DS			
Precio Price Prix	-			
Medidas/Measures/ Mesures [mm] Sin costados/Without sides/Sans joues	1625 x 810 x 1300 mm.	938 x 810 x 1300 mm.	1250 x 810 x 1300 mm.	1875 x 810 x 1300 mm.
Temperatura Temperature Température [°C]	R / SS / DS: +4°C/+8°C HT: +55°C/+65°C			
Clase Climática Climatic class Classe climatique [°C]	3 / 25°C			
Tensión/Frecuencia Electrical data Tension électrique	230V/1ph/50Hz			
Controlador Controller Régulateur	Digital			
Material Material Matériel [EXT/INT]	AISI 304			
Aislamiento Isolation Isolation [mm]	40kg/m <sup>3</sup> / Free CFC's / Zero ODP-GWP			
Capacidad Capacity Capacité [L]	180	274	365	548
Superficie exposición Surface exhibition Surface d'exposition [m <sup>2</sup> ]	0,9	1,4	1,9	2,8
Compresor Compressor Compresseur [HP]	1/3	3/4	3/4 DS: 1	1 1/4
Puertas / Estantes Doors / Shelving Portes / Étagères	R: - SS: - / 3	HT: - DS: -	R: 2 / 3 SS: - / 3	HT: 2 / 2 DS: 2 / 3
Costados [2] Sides [2] Joues [2] [mm]	20+20 (INCLUIDOS / INCLUDES / INCLUS)			
Sistema de frío Cooling System Système de froid	Ventilado / Ventilated / Ventilé			
Desescarche Defrost Dégivrage	Automático / Automatic / Automatique			
Evaporación Evaporation Évaporation	Semiestática / Semistatic / Semi-statique			
Potencia Power Puissance [W]	R: - SS: 404	HT: - DS: -	R: 708 SS: 708	HT: 1080 DS: 708
Potencia frig. Cooling capacity Puissance Frig. [W A -10°C]	750		1096	1315
Consumo Consumption Consommation [kWh/ 24h]	R: - SS: 5.65	HT: - DS: -	R: 8.5 SS: 9.25	HT: 9.85 DS: 7.54
Refrigerante Refrigerant Gaz	R-290			
Opcional Optional Options	Cristal frontal doble / Double front glass / Double front glass VON 9 VON 12 VON 18			

\*Este precio es aplicable cuando el cristal va incorporado en el mueble.  
This price is applicable when the glass is incorporated with the display case.  
Prix applicable quand la vitre est livrée dans la vitrine



Serie / Series / Série **ONIX**

+Info: [www.infrico.com](http://www.infrico.com)

VON HT



VON SS



**Laterales / Sides / Joues**

**Incluidos / Includes / Inclus**

**OPCIONAL Cristal frontal doble**  
**OPTIONAL Double frontal glass**  
**OPTION Double vitrage frontale**

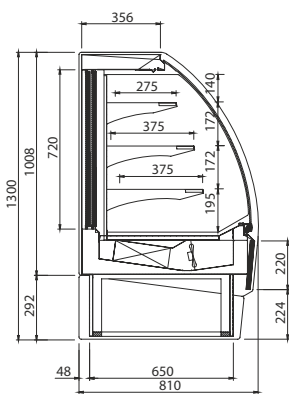

VNO R / DS

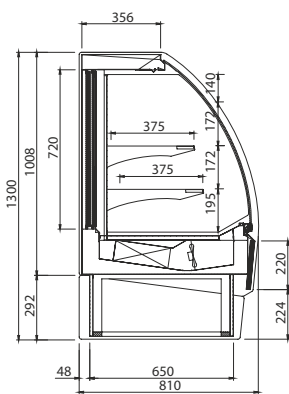



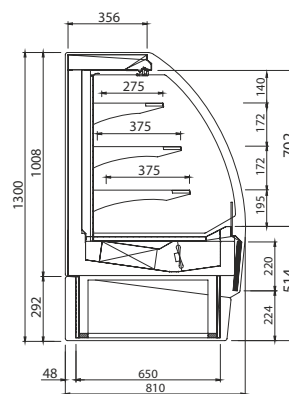

VON HT



VON SS

# Vitrina expositora para cafetería y pastelería/ Pastry display case / Vitrine d'exposition pour cafétéria et pâtisserie

MODELO MODELE MODÈLE	 VCO 9	 VCO 12	 VCO 15	 VCO 18
Precio Price Prix				
Medidas / Measures / Mesures (mm)	998 x 890 x 1455 mm.	1310 x 890 x 1455 mm.	1622 x 890 x 1455 mm.	1935 x 890 x 1455 mm.
Temperatura Temperature Température (°C)	<b>+2°C/+5°C</b>			
Clase Climática Climatic class Classe climatique (°C)	3 / 25°C			
Tensión/Frecuencia Electrical data Tension électrique	230V/1ph/50Hz			
Controlador Controller Régulateur	Digital			
Material Material Matériel (EXT/INT)	Acero plastificado / Plastified galvanised steel / Acier galvanisé plastifié Plano exposición / Exhibition plan / Plan d'exposition: Acero plastif. negro/ Plastif. Stainless steel black/ Acier plastifié noire			
Aislamiento Isolation Isolation (mm)	40kg/m <sup>3</sup> / Free CFC's / Zero ODP-GWP			
Capacidad Capacity Capacité (L)	186	248	310	372
Superficie exposición Surface exhibition Surface d'exposition (m <sup>2</sup> )	1.13	1.51	1.88	2.26
Compresor Compressor Compresseur (HP)	5/8	3/4	7/8	1
Estantes Shelving Étagères	1			
Costados (2) Sides (2) Joues (2) (mm)	30+30 <b>(INCLUIDOS / INCLUDES / INCLUS)</b>			
Sistema de frío Cooling System Système de froid	Ventilado / Ventilated / Ventilé			
Desescarche Defrost Dégivrage	Manual / Manual / Manuel			
Evaporación Evaporation Évaporation	Semiestática / Semistatic / Semiestatique			
Potencia Power Puissance (W)	436	616	682	740
Potencia frig. Cooling capacity Puissance Frig. (-10°C)	-			
Consumo Consumption Consommation (kWh/24h)	6,3	9,02	10,3	11,8
Refrigerante Refrigerant Gaz	<b>R-290</b>			
Opcional Optional Options	-			

Serie / Series / Série **COMBO**

+Info: [www.infrico.com](http://www.infrico.com)

VC015



← **Parte superior neutra**  
Neutral countertop  
Partie supérieure neutre

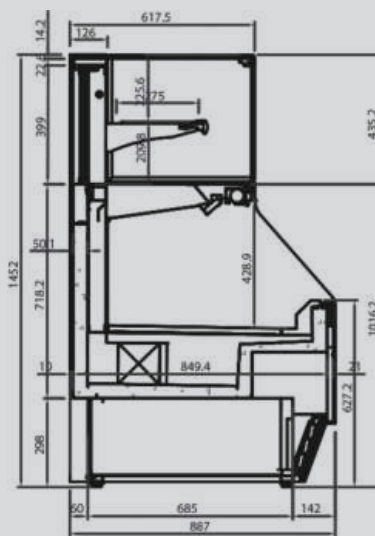







Laterales / Sides / Jous

Incluidos / Includes / Inclus

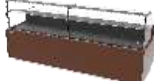

# Vitrina expositora frío ventilado con reserva, modular, para cafetería y pastelería/ Refrigerated modular pastry display case with storage / Vitrine d'exposition froid ventilé avec réserve, modulaire, pour cafétéria et pâtisserie

MODELO MODELE MODÈLE						
Precio Price Prix						
Medidas/Measures/ Mesures [mm] Sin costados/Without sides/Sans joues	938 x 960 x 1220 mm.	1250 x 960 x 1220 mm.	1562 x 960 x 1220 mm.	1875 x 960 x 1220 mm.	2500 x 960 x 1220 mm.	1250 x 960 x 1020 mm.
Temperatura Temperature [°C] Température	+4°C/+8°C					+7°C/+12°C
Clase Climática Climatic class [°C] Classe climatique	3 / 25°C					
Tensión/Frecuencia Electrical data Tension électrique	230V/1ph/50Hz					
Controlador Controller Régulateur	Digital					
Material Matériel [EXT/INT]	Ext: acero plastificado / Plastified steel / Acier plastifié Plano exposición / Exhibition plan / Plan d'exposition: Acero plastif. negro / Black plastif. Stainless steel / Acier plastifié noir					
Aislamiento Isolation [mm]	40kg/m <sup>3</sup> / Free CFC's / Zero ODP-GWP					
Capacidad Capacity [L] Capacité	106	141	177	212	283	141
Superficie exposición Surface exhibition [m <sup>2</sup> ] Surface d'exposition	0,13	0,17	0,22	0,26	0,35	0,17
Compresor Compressor [HP] Compresseur	1/3	1/3	1/2	3/4	1	-
Estantes / Puertas Shelving / Doors Étagères / Portes	1 Estante					
Costados [2] Sides [2] [mm] Joues [2]	30 + 30					
Sistema de frío Cooling System Système de froid	Ventilado / Ventilated / Ventilé					
Desescarche Defrost Dégivrage	Automático / Automatic / Automatique					
Evaporación Evaporation Évaporation	Ventilado / Ventilated / Ventilé					
Potencia Power [W] Puissance	419	430	588	654	857	430
Potencia frig. Cooling capacity [W A -10°C] Puissance Frig.	-					
Consumo Consumption [kWh/ 24h] Consommation	6,04	6,2	8,5	9,4	12,3	6,2
Refrigerante Refrigerant Gaz	R290					
Opcional Optional Options	<b>Puertas correderas traseras</b> Rear sliding doors Portes arrière coulissantes  <b>VMG 9 R</b> PUEVMG9CT <b>VMG 12 R</b> PUEVMG12CT <b>VMG 15 R</b> PUEVMG15CT <b>VMG 18 R</b> PUEVMG18CT <b>VMG 25 R</b> PUEVMG25CT					-

**Laterales no incluidos en el precio**  
Side panels not included in price  
Joues non incluses dans le prix

Serie / Series / Série **MAGNUS**

+Info: [www.infrico.com](http://www.infrico.com)

**Laterales / Sides / Joues**

NO	
Izquierdo Left Gauche	Derecho Right Droite

**Ext. Estándar / Standar / Standard**

Ral 9016	Ral 1001	Ral 1018
Ral 2003	Ral 3003	Ral 3020
Ral 4007	Design 3504035	Ral 5015
Design 1107060	Ral 6002	Design 2108025
Ral 8017	Ral 9006	Ral 7016
Nogal-Walnut-Noyer	Wengué-Wenge-Wenge	Ral 9017

**Colores fuera de carta /  
Colors outside of letter /  
Couleurs spéciales, hors palette**

RAL		NO RAL	
Epoxi	Líquida/ Liquid/ Liquide	Epoxi	Líquida/ Liquid/ Liquide
		Consultar / Consultar / Consulter	
[x unidad/x unit/x unité]			
+10 días laborables / +10 work days / +10 jours ouvrés		Consultar / Consultar / Consulter	

Estante de serie  
Standard shelv  
Étagère standard



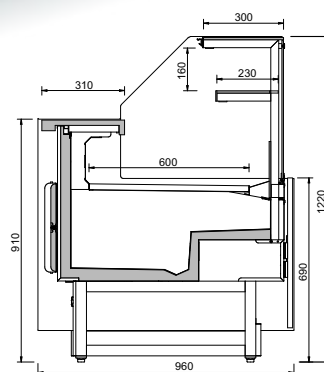

VMG25RU



VMG RU



**Vitrina expositora frío ventilado con reserva, modular, para cafetería y pastelería, cristal bajo / Refrigerated modular pastry display case with storage, low glass / Vitrine d'exposition froid ventilé avec réserve, modulaire, pour cafétéria et pâtisserie, verre bas**

MODELO MODELE MODÈLE					
	VMG 9 RU LG	VMG 12 RU LG	VMG 15 RU LG	VMG 18 RU LG	VMG 25 RU LG
<b>Precio</b> Price Prix					
<b>Medidas/Measures/</b> Mesures [mm] <b>Sin costados/Without</b> sides/Sans joues	938 x 960 x 1020 mm.	1250 x 960 x 1020 mm.	1562 x 960 x 1020 mm.	1875 x 960 x 1020 mm.	2500 x 960 x 1020 mm.
<b>Temperatura</b> Temperature [°C] Température	<b>+4°C/+8°C</b>				
<b>Clase Climática</b> Climatic class [°C] Classe climatique	3 / 25°C				
<b>Tensión/Frecuencia</b> Electrical data Tension électrique	230V/1ph/50Hz				
<b>Controlador</b> Controller Régulateur	Digital				
<b>Material</b> Material [EXT/INT] Matériel	Ext: acero plastificado / Plastified steel / Acier plastifié Plano exposición / Exhibition plan / Plan d'exposition: Acero plastif. negro / Black plastif. Stainless steel / Acier plastifié noir				
<b>Aislamiento</b> Isolation [mm] Isolation	40kg/m <sup>3</sup> / Free CFC's / Zero ODP-GWP				
<b>Capacidad</b> Capacity [L] Capacité		141	177	212	283
<b>Superficie exposición</b> Surface exhibition [m <sup>2</sup> ] Surface d'exposition	0,13	0,17	0,22	0,26	0,35
<b>Compresor</b> Compressor [HP] Compresseur		1/3	1/2	3/4	1
<b>Estantes / Puertas</b> Shelving / Doors Étagères / Portes	-				
<b>Costados [2]</b> Sides [2] [mm] Joues [2]	30 + 30				
<b>Sistema de frío</b> Cooling System Système de froid	Ventilado / Ventilated / Ventilé				
<b>Desescarche</b> Defrost Dégivrage	Automático / Automatic / Automatique				
<b>Evaporación</b> Evaporation Évaporation	Ventilado / Ventilated / Ventilé				
<b>Potencia</b> Power [W] Puissance	379	388	544	606	722
<b>Potencia frig.</b> Cooling capacity [W A -10°C] Puissance Frig.	-				
<b>Consumo</b> Consumption [kWh/ 24h] Consommation	5,01	5,12	7,18	8,00	9,53
<b>Refrigerante</b> Refrigerant Gaz	<b>R290</b>				
<b>Opcional</b> Optional Options	-				

**Laterales no incluidos en el precio**  
Side panels not included in price  
Joues non incluses dans le prix

Serie / Series / Série **MAGNUS**

+Info: [www.infrico.com](http://www.infrico.com)

VMG25LG

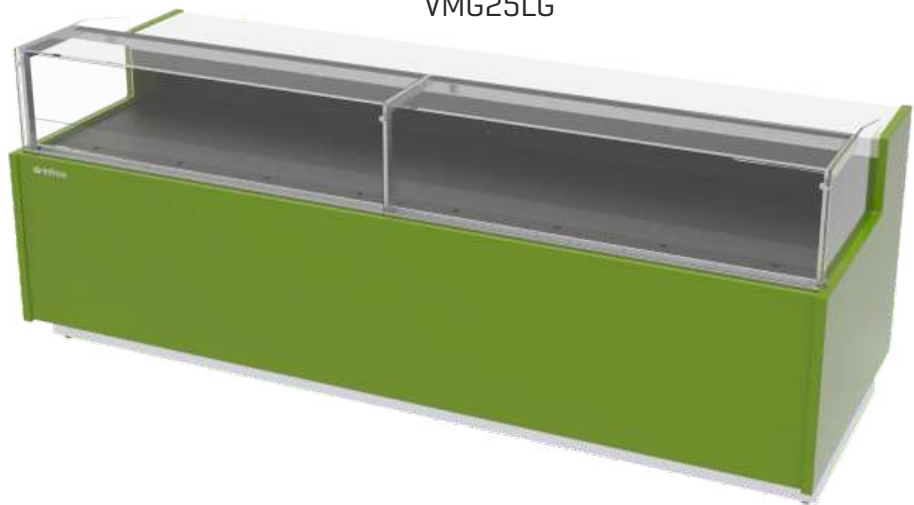

**Laterales / Sides / Joues**

NO	
Izquierdo Left Gauche	Derecho Right Droite

**Ext. Estándar / Standar / Standard**

Ral 9016	Ral 1001	Ral 1018
Ral 2003	Ral 3003	Ral 3020
Ral 4007	Design 3504035	Ral 5015
Design 1107060	Ral 6002	Design 2108025
Ral 8017	Ral 9006	Ral 7016
Nogal-Walnut-Noyer	Wengué-Wenge-Wenge	Ral 9017

**Colores fuera de carta / Colors outside of letter / Couleurs spéciales, hors palette**



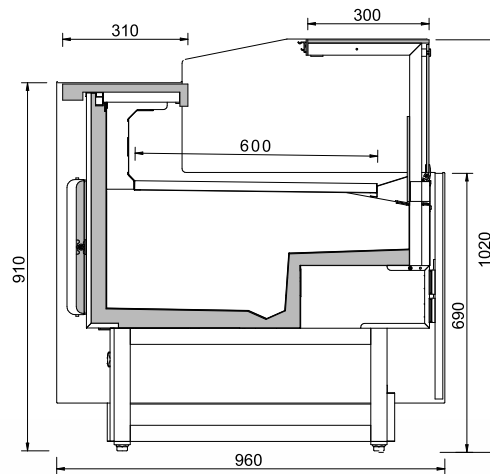

RAL		NO RAL	
Epoxi	Líquida/ Liquid/ Liquide	Epoxi	Líquida/ Liquid/ Liquide
[x unidad/x unit/x unité]		Consultar / Consultar / Consultar	
+10 días laborables / +10 work days / +10 jours ouvrés		Consultar / Consultar / Consultar	



VMG LG



# Vitrina expositora frío ventilado con reserva, modular, para cafetería y pastelería / Refrigerated modular pastry display case with storage / Vitrine d'exposition froid ventilé avec réserve, modulaire, pour cafétéria et pâtisserie

MODELO MODELE MODÈLE					
	VMG 90 AARU	VMG 90 ACRU	VMG 90 ARRU	VMG 45 AARU	VMG 45 ACRU
<b>Precio</b> Price Prix					
<b>Medidas/Measures/</b> Mesures [mm] <b>Sin costados/Without</b> sides/Sans joues	1365 x 960 x 1220 mm.	1750 x 960 x 1220 mm.	1365 x 960 x 1220 mm.	1180 x 960 x 1220 mm.	1365 x 960 x 1220 mm.
<b>Temperatura</b> Temperature [°C] Température	<b>+4°C/+8°C</b>				
<b>Clase Climática</b> Climatic class [°C] Classe climatique	3 / 25°C				
<b>Tensión/Frecuencia</b> Electrical data Tension électrique	230V/1ph/50Hz				
<b>Controlador</b> Controller Régulateur	Digital				
<b>Material</b> Material [EXT/INT] Matériel	Ext: acero plastificado / Plastified steel / Acier plastifié Plano exposición / Exhibition plan / Plan d'exposition: Acero plastif. negro / Black plastif. Stainless steel / Acier plastifié noir				
<b>Aislamiento</b> Isolation [mm] Isolation	40kg/m <sup>3</sup> / Free CFC's / Zero ODP-GWP				
<b>Capacidad</b> Capacity [L] Capacité	-				
<b>Superficie exposición</b> Surface exhibition [m <sup>2</sup> ] Surface d'exposition	0,9	1,2	1,1	0,8	0,9
<b>Compresor</b> Compressor [HP] Compresseur	1/2				
<b>Estantes / Puertas</b> Shelving / Doors Étagères / Portes	1				
<b>Costados [2]</b> Sides [2] [mm] Joues [2]	30 + 30				
<b>Sistema de frío</b> Cooling System Système de froid	Ventilado / Ventilated / Ventilé				
<b>Desescarche</b> Defrost Dégivrage	Automático / Automatic / Automatique				
<b>Evaporación</b> Evaporation Évaporation	Ventilado / Ventilated / Ventilé				
<b>Potencia</b> Power [W] Puissance	580	594	594	548	580
<b>Potencia frig.</b> Cooling capacity [W A -10°C] Puissance Frig.	-				
<b>Consumo</b> Consumption [kWh/ 24h] Consommation	8,3	8,5	8,5	7,9	8,3
<b>Refrigerante</b> Refrigerant Gaz	<b>R290</b>				
<b>Opcional</b> Optional Options	<p><b>Puertas correderas traseras</b> Rear sliding doors Portes arrières coulissantes</p> <p><b>VMG 90 AARU</b> PUEVMG90AACT  <b>VMG 90 ACRU</b> PUEVMG90ACCT  <b>VMG 90 ARRU</b> PUEVMG90ARCT  <b>VMG 45 AARU</b> PUEVMG45AACT  <b>VMG 45 ACRU</b> PUEVMG45ACCT</p>				

**Laterales no incluidos en el precio**  
Side panels not included in price  
Joues non incluses dans le prix



Serie / Series / Série **MAGNUS**

+Info: [www.infrico.com](http://www.infrico.com)

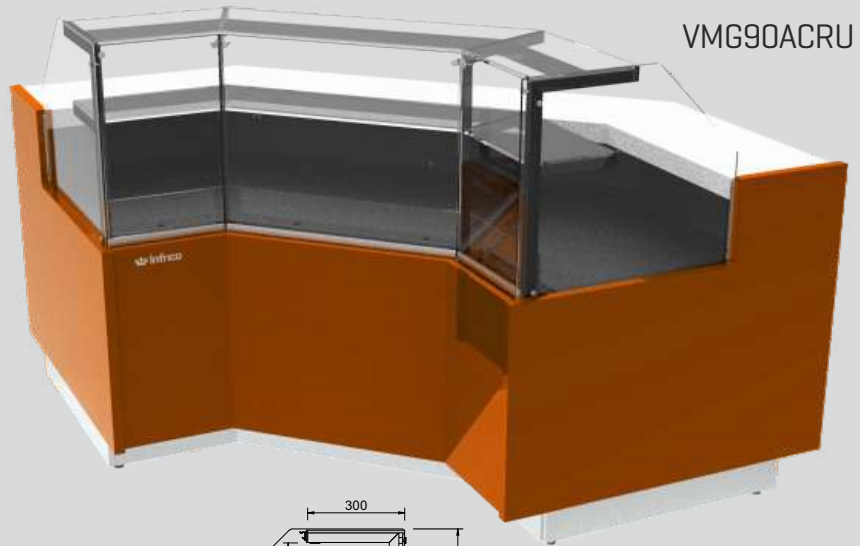

VMG90ACRU

**Laterales / Sides / Joues**

NO	
Izquierdo Left Gauche	Derecho Right Droite

**Ext. Estándar / Standar / Standard**

Ral 9016	Ral 1001	Ral 1018
Ral 2003	Ral 3003	Ral 3020
Ral 4007	Design 3504035	Ral 5015
Design 1107060	Ral 6002	Design 2108025
Ral 8017	Ral 9006	Ral 7016
Nogal-Walnut-Noyer	Wengué-Wenge-Wenge	Ral 9017

**Colores fuera de carta / Colors outside of letter / Couleurs spéciales, hors palette**

RAL		NO RAL	
Epoxi	Líquida/ Liquid/ Liquide	Epoxi	Líquida/ Liquid/ Liquide
[x unidad/x unit/x unité]		Consultar / Consultar / Consulter	
+10 días laborables / +10 work days / +10 jours ouvrés		Consultar / Consultar / Consulter	

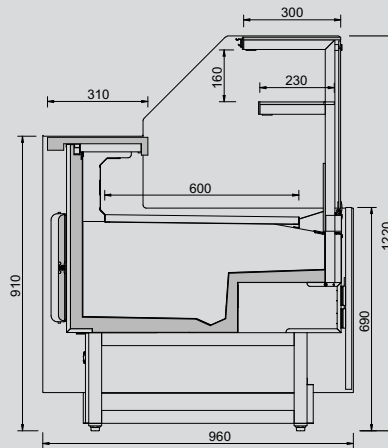







VMG



**Vitrina expositora modular neutra (panera) /**  
**Neutral modular display case /**  
**Vitrine d'exposition modulaire neutre**

**Mueble caja /**  
**Counter case /**  
**Meuble caisse**

MODELO MODELE MODÈLE	VITRINA / DISPLAY CASE / VITRINE		MUEBLE CAJA / COUNTER CASE / MEUBLE CAISSE			
	 VMG 9 P	 VMG 12 P	 VMG 90 AAM	 VMG 90 ACM	 VMG 45 AAM	 VMG 45 ACM
Precio Price Prix						
Medidas/Measures/ Mesures [mm] Sin costados/Without sides/Sans joues	938 x 960 x 1345 mm.	1250 x 960 x 1345 mm.	1365 x 960 x 1345 mm.	1750 x 960 x 1345 mm.	1180 x 960 x 920 mm.	1365 x 960 x 920 mm.
Temperatura Temperature [°C] Température	-					
Clase Climática Climatic class [°C] Classe climatique	3 / 25°C					
Tensión/Frecuencia Electrical data Tension électrique	-		230V/1ph/50Hz			
Controlador Controller Régulateur	-					
Material Matériel [EXT/INT]	Ext: acero plastificado / Plastified steel / Acier plastifié Plano exposición / Exhibition plan / Plan d'exposition: Acero plastif. negro / Black plastif. Stainless steel / Acier plastifié noir					
Aislamiento Isolation [mm]	40kg/m <sup>3</sup> / Free CFC's / Zero ODP-GWP					
Capacidad Capacity [L] Capacité	-					
Superficie exposición Surface exhibition [m <sup>2</sup> ] Surface d'exposition	0,6	0,8	-			
Compresor Compressor [HP] Compresseur	-		-			
Estantes Shelving Étagères	1		-			
Costados (2) Sides (2) [mm] Joues (2)	30 + 30					
Sistema de frío Cooling System Système de froid	-					
Desescarche Defrost Dégivrage	-					
Evaporación Evaporation Évaporation	-					
Potencia Power [W] Puissance	24	30	7	10	5	7
Potencia frig. Cooling capacity [W A -10°C] Puissance Frig.	-					
Consumo Consumption [kWh/ 24h] Consommation	0,4	0,5	0,1	0,2	0,1	0,2
Refrigerante Refrigerant Gaz	-					
Opcional Optional Options	-					

Serie / Series / Série **MAGNUS**

+Info: [www.infrico.com](http://www.infrico.com)

VMG12P



**Laterales / Sides / Jous**

**Incluidos / Includes / Inclus**

**Ext. Estándar / Standar / Standard**

Ral 9016	Ral 1001	Ral 1018
Ral 2003	Ral 3003	Ral 3020
Ral 4007	Design 3504035	Ral 5015
Design 1107060	Ral 6002	Design 2108025
Ral 8017	Ral 9006	Ral 7016
Nogal-Walnut-Noyer	Wengué-Wenge-Wenge	Ral 9017

**Colores fuera de carta / Colors outside of letter / Couleurs spéciales, hors palette**

RAL		NO RAL	
Epoxi	Líquida/ Liquid/ Liquide	Epoxi	Líquida/ Liquid/ Liquide
[x unidad/x unit/x unité]		Consultar / Consulter / Consulter	
+10 días laborables / +10 work days / +10 jours ouvrés		Consultar / Consulter / Consulter	

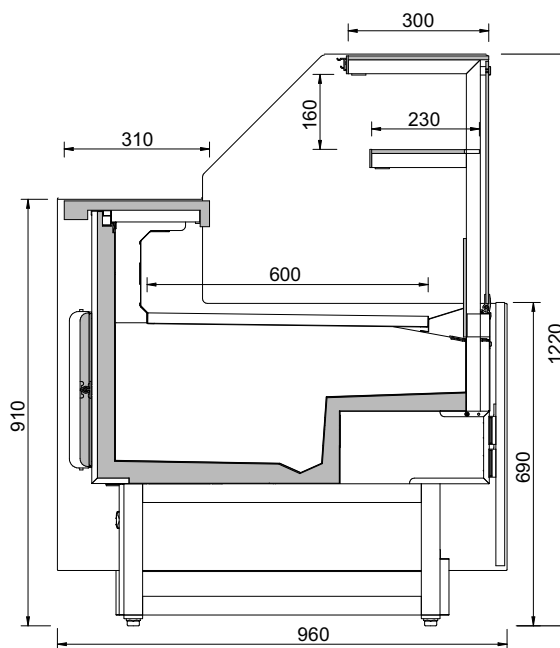





VMG P



**Mueble caja /  
Counter case /  
Meuble caisse**

Serie / Series / Série **MAGNUS**

MODELO MODELE MODÈLE	 <b>VMG 9 C</b>	 <b>VMG 12 M</b>	 <b>VMG 18 M</b>	 <b>VMG 12 MHD</b>
Precio Price Prix				
Medidas/Measures/ Mesures [mm] Sin costados/Without sides/Sans joues	938 x 960 x 690 mm.	1250 x 960 x 690 mm.	1875 x 960 x 690 mm.	1250 x 960 x 736 mm.
Costados [2] Sides [2] Joues [2] [mm]	30 + 30			

VMG12MHD



+Info: [www.infrico.com](http://www.infrico.com)

## VMG12M

Laterales / Sides / Jous

Incluidos / Includes / Inclus

Ext. Estándar / Standar / Standard

Ral 9016	Ral 1001	Ral 1018
Ral 2003	Ral 3003	Ral 3020
Ral 4007	Design 3504035	Ral 5015
Design 1107060	Ral 6002	Design 2108025
Ral 8017	Ral 9006	Ral 7016
Nogal-Walnut-Noyer	Wengué-Wenge-Wenge	Ral 9017

Colores fuera de carta /  
Colors outside of letter /  
Couleurs spéciales, hors palette

RAL		NO RAL	
Epoxi	Líquida/ Liquid/ Liquide	Epoxi	Líquida/ Liquid/ Liquide
(x unidad/x unit/x unité)		Consultar / Consultar / Consultar	
+10 días laborables / +10 work days / +10 jours ouvrés		Consultar / Consultar / Consultar	



# Vitrina expositora helados / Gelato display case / Vitrine d'exposition pour glace

MODELO  
MODELE  
MODÈLE



VCB 12 UH



VCB 15 UH



VCB 18 UH

	VCB 12 UH	VCB 15 UH	VCB 18 UH
Precio Price Prix			
Medidas/Measures/ Mesures [mm] Sin costados/Without sides/Sans joues	1250 x 1052 x 1200 mm.	1562 x 1052 x 1200 mm.	1875 x 1052 x 1200 mm.
Temperatura Temperature [°C] Température	<b>-15°C/-18°C</b>		
Clase Climática Climatic class [°C] Classe climatique	7 / 35°C		
Tensión/Frecuencia Electrical data Tension électrique	230V/1ph/50Hz		
Controlador Controller Régulateur	Digital		
Material Material [EXT/INT] Matériel	Acero plastificado / Plastified galvanised steel / Acier galvanisé plastifié Plano exposición / Exhibition plan / Plan d'exposition: Inox Aisi 304		
Aislamiento Isolation [mm] Isolation	40kg/m <sup>3</sup> / Free CFC's / Zero ODP-GWP		
Capacidad Capacity [L] Capacité	182	228	274
Superficie exposición Surface exhibition [m <sup>2</sup> ] Surface d'exposition	0,96	1,20	1,49
Compresor Compressor [HP] Compresseur	1 1/4	1 1/4 + 1	1 1/4 + 1
Bandejas Shelving Bacs	8 / 14	10 / 16	14 / 20
Costados [2] Sides [2] [mm] Joues [2]	20 + 20		
Sistema de frío Cooling System Système de froid	Ventilado / Ventilated / Ventilé		
Desescarche Defrost Dégivrage	Gas caliente / Hot gas / Gaz chaud		
Evaporación Evaporation Évaporation	Ventilado / Ventilated / Ventilé		
Potencia Power [W] Puissance	1250	1570	1640
Potencia frig. Cooling capacity [W A -10°C] Puissance Frig.	-		
Consumo Consumption [kWh/ 24h] Consommation	19,7	28,9	30,8
Refrigerante Refrigerant Gaz	<b>R-290</b>		
Opcional Optional Options	<b>230v/1ph/60 Hz</b>		
	<b>Combinación de bandejas / Tray combinations / Combinaisons de bacs</b>		
		(501X36) x 8uds. (501X32) x 14uds. (501X36) x 10uds. (501X32) x 16uds. (501X36) x 14uds. (501X32) x 20uds.	<b>VCB12UH</b> <b>VCB15UH</b> <b>VCB18UH</b>
	<b>Puertas correderas traseras / Rear sliding doors / Portes arrière coulissantes</b>  PUEVCB12CT	<b>Puertas correderas traseras / Rear sliding doors / Portes arrière coulissantes</b>  PUEVCB15CT	<b>Puertas correderas traseras / Rear sliding doors / Portes arrière coulissantes</b>  PUEVCB18CT

Serie / Series / Série **CORAL**

+Info: [www.infrico.com](http://www.infrico.com)

VCB15UH

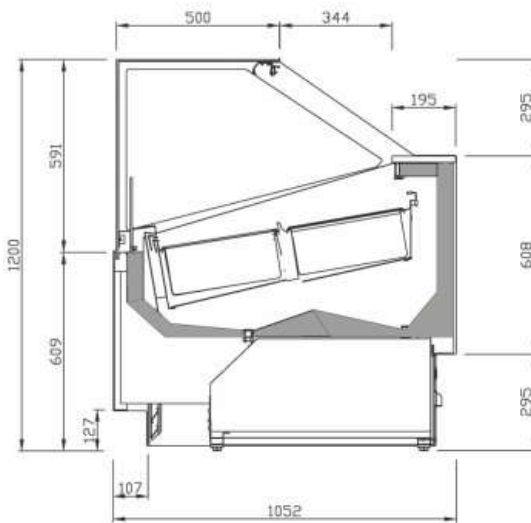

VCB12UH

[501X36]  
x 8 uds.

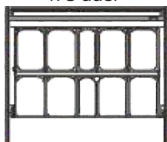

8

[501X32]  
x 14 uds.

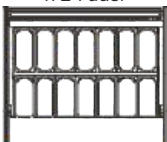

14

VCB18UH

[501X36]  
x 10 uds.

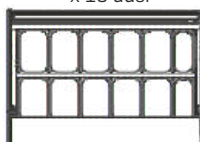

10

[501X32]  
x 16 uds.

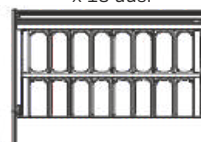

16

VCB18UH

[501X36]  
x 14 uds.



14

[501X32]  
x 20 uds.



20



**Laterales / Sides / Joues**

**Incluidos / Includes / Inclus**

**Ext. Estándar / Standar / Standard**

Ral 9016	Ral 1001	Ral 1018
Ral 2003	Ral 3003	Ral 3020
Ral 4007	Design 3504035	Ral 5015
Design 1107060	Ral 6002	Design 2108025
Ral 8017	Ral 9006	Ral 7016
Ral 9017		

**Colores fuera de carta / Colors outside of letter / Couleurs spéciales, hors palette**

RAL		NO RAL	
Epoxi	Líquida/ Liquid/ Liquide	Epoxi	Líquida/ Liquid/ Liquide
(x unidad/x unit/x unité)		Consultar / Consultar / Consulter	
+10 días laborables / +10 work days / +10 jours ouvrés		Consultar / Consultar / Consulter	

Los datos técnicos están sujetos a posibles variaciones que serán actualizadas periódicamente en las fichas técnicas del producto, disponibles en la web / The technical data are subject to possible variations that will be updated periodically in the technical data sheets of the product, which are available on the website / Les données techniques peuvent varier et seront actualisées dans les fiches techniques du produit, disponibles sur le site web.

# Vitrina expositora helados / Gelato display case / Vitrine d'exposition pour glace



**VAR 12 H**



**VAR 15 H**



**VAR 18 H**

MODELO MODELE MODÈLE	VAR 12 H	VAR 15 H	VAR 18 H
Precio Price Prix			
Medidas/Measures/ Mesures [mm] Sin costados/Without sides/Sans joues	1250 x 1145 x 1320 mm.	1562 x 1145 x 1320 mm.	1875 x 1145 x 1320 mm.
Temperatura Temperature [°C] Température	<b>-15°C/-18°C</b>		
Clase Climática Climatic class [°C] Classe climatique	7 / 35°C		
Tensión/Frecuencia Electrical data Tension électrique	230V/1ph/50Hz		
Controlador Controller Régulateur	Digital		
Material Material [EXT/INT] Matériel	Acero plastificado / Plastified galvanised steel / Acier galvanisé plastifié Plano exposición / Exhibition plan / Plan d'exposition: Inox Aisi 304		
Aislamiento Isolation [mm] Isolation	40kg/m <sup>3</sup> / Free CFC's / Zero ODP-GWP		
Capacidad Capacity [L] Capacité	182	228	274
Superficie exposición Surface exhibition [m <sup>2</sup> ] Surface d'exposition	0,96	1,26	1,44
Compresor Compressor [HP] Compresseur	1 1/4	1 1/4 + 1	1 1/4 + 1
Bandejas Shelving Bacs	8 / 14	10 / 16	14 / 20
Costados [2] Sides [2] [mm] Joues [2]	40 +40		
Sistema de frío Cooling System Système de froid	Ventilado / Ventilated / Ventilé		
Desescarche Defrost Dégivrage	Gas caliente / Hot gas / Gaz chaud		
Evaporación Evaporation Évaporation	Ventilado / Ventilated / Ventilé		
Potencia Power [W] Puissance	1020	1536	1640
Potencia frig. Cooling capacity [W A -10°C] Puissance Frig.	-		
Consumo Consumption [kWh/ 24h] Consommation	19,7	28,9	30,8
Refrigerante Refrigerant Gaz	<b>R-290</b>		
Opcional Optional Options	<p><b>230v/1ph/60 Hz</b></p> <p><b>Combinación de bandejas</b> Tray combinations Combinaisons de bacs</p> <p>[501X36] x 8uds.   <b>VAR12H</b></p> <p>[501X32] x 14uds.   <b>VAR15H</b></p> <p>[501X36] x 10uds.   <b>VAR15H</b></p> <p>[501X32] x 16uds.   <b>VAR15H</b></p> <p>[501X36] x 14uds.   <b>VAR18H</b></p> <p>[501X32] x 20uds.   <b>VAR18H</b></p>		



Serie / Series / Série **ARIES**

+Info: [www.infrico.com](http://www.infrico.com)

VAR15H

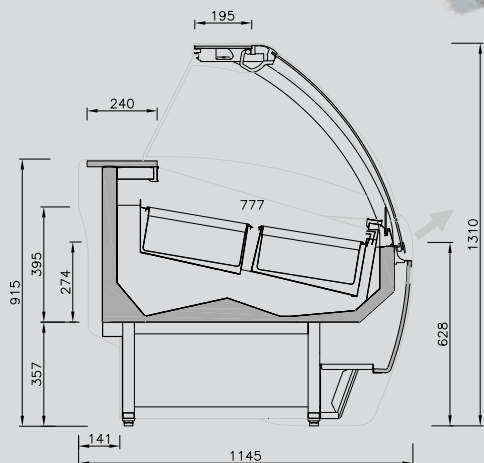

VAR15H



**Cristal elevable**  
Lift-up glass  
Vitre relevable

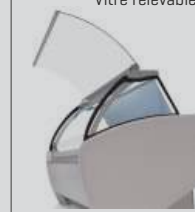

**Laterales / Sides / Joues**

**Incluidos / Includes / Inclus**

**Ext. Estándar / Standar / Standard**

Ral 9016	Ral 1001	Ral 1018
Ral 2003	Ral 3003	Ral 3020
Ral 4007	Design 3504035	Ral 5015
Design 1107060	Ral 6002	Design 2108025
Ral 8017	Ral 9006	Ral 7016
Ral 9017		

VAR12H



**8** [501X36] x 8 uds.      **14** [501X32] x 14 uds.

VAR15H

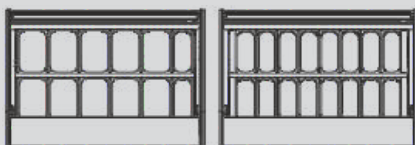

**10** [501X36] x 10 uds.      **16** [501X32] x 16 uds.

VAR18H



**14** [501X36] x 14 uds.      **20** [501X32] x 20 uds.

**Combinación de bandejas**  
Combination of trays  
Combinaison de bacs



**Cortina nocturna**  
Night curtain  
Rideau de nuit



**Colores fuera de carta / Colors outside of letter / Couleurs spéciales, hors palette**

RAL		NO RAL	
Epoxi	Líquida/ Liquid/ Liquide	Epoxi	Líquida/ Liquid/ Liquide
[x unidad/x unit/x unité]		Consultar / Consulter / Consulter	
+10 días laborables / +10 work days / +10 jours ouvrés		Consultar / Consulter / Consulter	

**Bandeja evaporativa extraíble**  
Removable evaporation tray  
Bac d'évaporation extractable



# Vitrina estática expositora helados / Gelato static display case / Vitrine statique d'exposition pour glace

MODELO  
MODELE  
MODÈLE



	VBZ 12U	VBZ 15U	VBZ 12 SU	VBZ 15 SU
<b>Precio</b> Price Prix				
<b>Medidas</b> Measures Mesures (mm)	1310 x 920 x 1350 mm.	1622 x 920 x 1350 mm.	1310 x 670 x 1350 mm.	1622 x 670 x 1350 mm.
<b>Temperatura</b> Temperature Température (°C)	-15°C/-18°C			
<b>Clase Climática</b> Climatic class Classe climatique (°C)	7 / 35°C			
<b>Tensión/Frecuencia</b> Electrical data Tension électrique	230V/1ph/50Hz			
<b>Controlador</b> Controller Régulateur	Digital			
<b>Material</b> Material Matériel (EXT/INT)	Acero plastificado / Plastified galvanised steel / Acier galvanisé plastifié Plano exposición / Exhibition plan / Plan d'exposition: Inox Aisi 304			
<b>Aislamiento</b> Isolation Isolation (mm)	40kg/m <sup>3</sup> / Free CFC's / Zero ODP-GWP			
<b>Capacidad</b> Capacity Capacité (L)	289	361	210	263
<b>Superficie exposición</b> Surface exhibition Surface d'exposition (m <sup>2</sup> )	0,94	1,41	0,50	0,63
<b>Compresor</b> Compressor Compresseur (HP)	1		3/4	
<b>Bandejas</b> Shelving Bacs	10+10	13+13	7+7	9+9
<b>Costados (2)</b> Sides (2) Joues (2) (mm)	30 +30			
<b>Sistema de frío</b> Cooling System Système de froid	Estático / Static / Statique			
<b>Desescarche</b> Defrost Dégivrage	Gas caliente / Hot gas / Gaz chaud			
<b>Evaporación</b> Evaporation Évaporation	Ventilado / Ventilated / Ventilé			
<b>Potencia</b> Power Puissance (W)	480	484	432	436
<b>Potencia frig.</b> Cooling capacity Puissance Frig. (W A -10°C)	-			
<b>Consumo</b> Consumption Consommation (kWh/ 24h)	11,5	13,6	9,9	11,5
<b>Refrigerante</b> Refrigerant Gaz	<b>R-290</b>			
<b>Opcional</b> Optional Options	<b>Ruedas de serie</b> Tray combinations Combinaisons de bacs			
	<b>Combinación de bandejas</b> Tray combinations Combinaisons de bacs			
	VBZ12 [501X32] x 10 uds. VBZ15 [501X32] x 13 uds.		VBZ12S [501X32] x 7 uds. VBZ15S [501X32] x 9 uds.	

Serie / Series / Série **IBIZA**

+Info: [www.infrico.com](http://www.infrico.com)

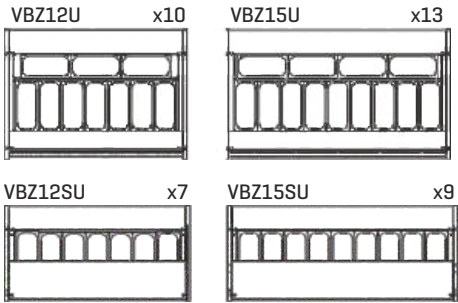

**Laterales / Sides / Jous**

**Incluidos / Includes / Inclus**

**Ext. Estándar / Standar / Standard**

Ral 9016	Ral 1001	Ral 1018
Ral 2003	Ral 3003	Ral 3020
Ral 4007	Design 3504035	Ral 5015
Design 1107060	Ral 6002	Design 2108025
Ral 8017	Ral 9006	Ral 7016
Ral 9017		

**Colores fuera de carta / Colors outside of letter / Couleurs spéciales, hors palette**

RAL		NO RAL	
Epoxi	Líquida/ Liquid/ Liquide	Epoxi	Líquida/ Liquid/ Liquide
(x unidad/x unit/x unité)		Consultar / Consultar / Consultar	
+10 días laborables / +10 work days / +10 jours ouvrés		Consultar / Consultar / Consultar	

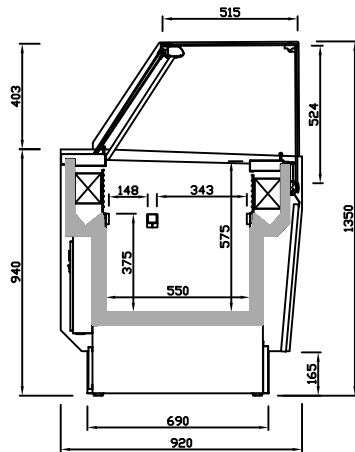

VBZ U



PHOTOBOOK



+Info: [www.infrico.com](http://www.infrico.com)



Los datos técnicos están sujetos a posibles variaciones que serán actualizadas periódicamente en las fichas técnicas del producto, disponibles en la web /  
The technical data are subject to possible variations that will be updated periodically in the technical data sheets of the product, which are available on the website /  
Les données techniques peuvent varier et seront actualisées dans les fiches techniques du produit, disponibles sur le site web.



# Horeca

Horeca / Négoce





# 12. Horeca

## Horeca Equipment / Négoce

<small>Serie / Series / Série</small>	<b>FHC ICE CUBE</b>	<b>Dispensador/Fabricador de hielo cubito macizo</b> Dispenser/Ice maker solid cube / Dispensateur/Machines à glaçons solides	<b>492-493</b>
<small>Serie / Series / Série</small>	<b>FHCM/SPLIT ICE CUBE</b>	<b>Fabricador de hielo cubito macizo</b> Ice maker solid cube / Machines à glaçons solides	<b>493</b>
<small>Serie / Series / Série</small>	<b>FHC B-CUBE</b>	<b>Fabricador de hielo cubito macizo cuadrado</b> Ice maker square solid cube / Machines à glaçons solides carrés	<b>494</b>
<small>Serie / Series / Série</small>	<b>IMF</b>	<b>Fabricador de hielo hueco</b> Hollow ice maker / Machines à glaçons creux	<b>495</b>
<small>Serie / Series / Série</small>	<b>FHTB/ FHTBM PEBBLES</b>	<b>Fabricador de hielo troceado</b> Cubed ice maker / Machines à glaçons en morceau	<b>496-497</b>
<small>Serie / Series / Série</small>	<b>FHT/FHTM ICE FLAKES</b>	<b>Fabricador de hielo troceado</b> Cubed ice maker / Machines à glaçons en morceau	<b>498</b>
<small>Serie / Series / Série</small>	<b>FHTM/SPLIT ICE FLAKES</b>	<b>Fabricador de hielo troceado</b> Cubed ice maker / Machines à glaçons en morceau	<b>499</b>
<small>Serie / Series / Série</small>	<b>FHES COLD FLAKES</b>	<b>Fabricador de hielo en escama</b> Flake ice maker / Machines à glaçons à pailletes	<b>500</b>
<small>Serie / Series / Série</small>	<b>FHES/SPLIT COLD FLAKES</b>	<b>Fabricador de hielo en escama</b> Flake ice maker / Machines à glaçons à pailletes	<b>501</b>
<small>Serie / Series / Série</small>	<b>DPE/DI</b>	<b>Almacén fabricante de hielo</b> Ice maker storage / Stockage pour machines à glaçons	<b>502</b>
<small>Serie / Series / Série</small>	<b>ROLLER BIN/ DOBLE ROLLER BIN</b>	<b>Almacén de hielo</b> Ice storage / Stockage pour glaçons	<b>509</b>



+Info: [www.infrico.com](http://www.infrico.com)

Serie / Series / Série

**ELECTROMECÁNICA**  
**ELECTROMECHANICAL**  
**ÉLECTROMÉCANIQUE****Lavavasos y lavaplatos**  
Glasswasher, dishwasher and hood dishwasher / Lave-vaisselle**504 - 507**

Serie / Series / Série

**ELECTRÓNICA**  
**ELECTRONIC**  
**ÉLECTRONIQUE****Lavavasos y lavaplatos**  
Glasswasher, dishwasher and hood dishwasher / Lave-vaisselle**508 - 511**

Serie / Series / Série

**Accesorios lavavasos y lavaplatos cúpula**  
Dishwasher accesories / Accessoires lave-vaisselle**512 - 513**

Serie / Series / Série

**LP****Lavautensilios y lavaperolas**  
Dishwasher / Lave-ustensiles**514 - 515**

Serie / Series / Série

**TA****Túneles de lavado y arrastre**  
Rack conveyor dishwasher / Tunnels de lavage**516 - 517**

Serie / Series / Série

**Accesorios Túnel de lavado**  
Rack conveyor dishwasher accesories / Accessoires tunnels de lavage**518 - 519**

Serie / Series / Série

**HF****Congelador tapa abatible - puerta corredera**  
Lid chest freezer - Sliding doors conservator  
Congélateur avec couvercle battant - coulissant**520 - 521**

Serie / Series / Série

**NEW****UL / PRO****Congelador -70 / -60°**  
Freezer -70 / -60°  
Congélateur -70 / -60°**528 - 529**

Serie / Series / Série

**IL / CHE****Conservadora expositora puerta cristal**  
Horizontal freezer with glass lid / Conservateur panoramique pour surgelés**524 - 525**

# 12. Horeca

## Horeca Equipment / Négoce

Serie / Series / Série		
<b>EHC EHC D EHC R</b>	<b>Conservadora expositora puerta cristal curvada</b> Conservative of curved glass crystal door Conservateur panoramique pour surgelés	<b>526 - 527</b>
Serie / Series / Série		
<b>NEW</b> <b>EHC VISION VSC</b>	<b>Conservadora expositora horizontal Visión compresor VSC</b> Vision horizontal display conservative, VSC compressor Conservateur panoramique Vision, compresseur VSC	<b>528 - 529</b>
Serie / Series / Série		
<b>MINI ARMARIO</b>	<b>Armario de refrigeración y congelación</b> Chillers and freezers / Congélateur vertical	<b>530 - 531</b>
Serie / Series / Série		
<b>NEW</b> <b>400L</b>	<b>Armario de refrigeración y congelación 400L</b> 400L Chillers and freezers / Congélateur vertical 400L	<b>532 - 533</b>
Serie / Series / Série		
<b>CV</b>	<b>Congelador vertical</b> Vertical freezer / Congélateur vertical	<b>534 - 535</b>
Serie / Series / Série		
<b>LO LO SOFT AIR LO NO-FROST</b>	<b>Armario expositor heladería y pastelería</b> Exhibiting cupboard for ice-cream and pastry Armoire d'exposition pour la glace et la pâtisserie	<b>536 - 541</b>
Serie / Series / Série		
<b>VITRA VITRA SOFT AIR VITRA NO-FROST</b>	<b>Armario expositor heladería y pastelería</b> Exhibiting cupboard for ice-cream and pastry Armoire d'exposition pour la glace et la pâtisserie	<b>542 - 549</b>
Serie / Series / Série		
<b>NEW</b> <b>HDC</b>	<b>Murales calientes /</b> Hot display cabinet / Murale d'exposition chaude	<b>550 - 551</b>
Serie / Series / Série		
<b>HT</b>	<b>Carros calientes de distribución /</b> Heated banquet trolleys / Chariot distributeur maintien au chaud	<b>552 - 553</b>
Serie / Series / Série		
<b>MICROONDAS HM</b>	<b>Horno microondas profesional</b> Professional microwave oven / Four micro-ondes professionnel	<b>554 - 555</b>
Serie / Series / Série		
<b>FERMENTADOR</b>	<b>Armario caliente fermentador</b> Fermentation ovens / Armoire de fermentation	<b>556 - 557</b>
<b>HORNO ELÉCTRICO HE</b>	<b>Horno eléctrico para panadería</b> Electric bakery oven / Fours pour la boulangerie	

Serie / Series / Série			
<b>VACE</b>	<b>Envasadora al vacío de aspiración externa</b> External aspiration vacuum packaging machine Machine sous vide à aspiration extérieure	<b>558</b>	
Serie / Series / Série			
<b>TSB</b>	<b>Máquina termoselladora</b> Thermosealer machine / Machines thermo-soudeuses	<b>559</b>	
Serie / Series / Série			
<b>VACT</b>	<b>Envasadora al vacío por tiempo</b> Time vacuum packaging machine / Machines sous vide pour temps	<b>560</b>	
Serie / Series / Série			
<b>VACS</b>	<b>Envasadora al vacío por sensor</b> Sensor vacuum packaging machine / Machines sous vide pour senseur	<b>561</b>	
Serie / Series / Série			
<b>PG PG/PE</b>	<b>Plancha a gas - Plancha eléctrica</b> Gas - Electrical griddles / Plancha à gaz - électrique	<b>562 - 563</b>	
Serie / Series / Série			
<b>GR</b>	<b>Grill eléctrico</b> Electrical grill / Grill panini électrique	<b>564</b>	
Serie / Series / Série			
<b>FR</b>	<b>Freidora eléctrica</b> Electrical fryer / Friteuse électrique	<b>565</b>	
Serie / Series / Série			
<b>NEW</b>	<b>SE / SEUF / SG</b>	<b>Salamandra / Salamander / Salamandre</b>	<b>566-567</b>
Serie / Series / Série			
<b>TTV-TTH / T</b>	<b>Tostador de túnel eléctrico - Tostador eléctrico</b> Electric tunnel toaster-Electric toaster / Toaster à tunnel électrique-Toaster électrique	<b>568 - 569</b>	
Serie / Series / Série			
<b>TL</b>	<b>Termo de leche</b> Milk urns / Termo de lait	<b>570</b>	
Serie / Series / Série			
<b>CS CSCEV</b>	<b>Cortadora de fiambre</b> Sharpening slicers / Trancheuse professionnelle	<b>571</b>	



**Dispensador / Fabricador de hielo cubito macizo /**  
**Dispenser / Ice maker solid ice cube /**  
**Dispensateur / Machines à glaçons solides**

**Serie / Series / Série FHC Ice Cube**

FHIKU26AHC

**NEW**



FHDSS42A/W

**NEW**



FHC20AHC/WHC



FHC80AHC/WHC



**Serie C: cubito macizo con almacén**  
**C Series: solid ice cube with storage**  
**Séries C: bloc glaçon avec stockage**

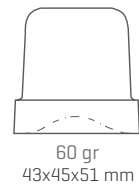
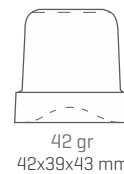
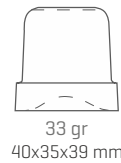

**DISPENSADOR / DISPENSER / DISPENSEUR**  
  
 13 gr

**FABRICADOR/ICEMAKER/MACHINE À GLAÇONS**

MODELO/MODELE/MODÈLE	FHIKU26AHC	FHDSS42A FHDSS42W	FHC20AHC FHC20WHC	FHC30AHC FHC30WHC	FHC35AHC FHC35WHC	FHC40AHC FHC40WHC	FHC45AHC FHC45WHC	FHC65AHC FHC65WHC	FHC80AHC FHC80WHC	FHC90AHC FHC90WHC	
<b>Precio</b> Price Prix											
<b>Medidas</b> Measures [mm] Mesures	↔ 395 ↗ 530 ↓ 790	↔ 500 ↗ 630 ↓ 920	↔ 355 ↗ 404 ↓ 590	↔ 390 ↗ 460 ↓ 690	↔ 500 ↗ 580 ↓ 690	↔ 500 ↗ 580 ↓ 690	↔ 500 ↗ 580 ↓ 800	↔ 735 ↗ 603 ↓ 850	↔ 738 ↗ 600 ↓ 920	↔ 738 ↗ 600 ↓ 1020	
<b>Tensión/Frecuencia</b> Electrical data [V/Hz] Tension électrique	Medidas sin patas / Measurements without legs / Dimensions sans pieds Patas regulables / Adjustable legs / Pieds réglables [110-150mm] 220V-240V/50Hz										
<b>Material</b> Material Matériel	Termoconf. Thermof. Thermof.	AISI 304									
<b>Condensación</b> Condensation Condenseur	Aire Air Air	Aire / Agua Air / Water Air / Eau	Aire / Agua Air / Water Air / Eau	Aire / Agua Air / Water Air / Eau	Aire / Agua Air / Water Air / Eau	Aire / Agua Air / Water Air / Eau	Aire / Agua Air / Water Air / Eau	Aire / Agua Air / Water Air / Eau	Aire / Agua Air / Water Air / Eau	Aire / Agua Air / Water Air / Eau	
<b>Cubito</b> Cubes Glaçons	[gr]	13	13	42	42	42	42	42	42	42	
<b>Producción</b> Production Compresseur	[Kg/24h]	24	44	21	29	38	42	48	72	80	95
<b>Almacén</b> Warehouse Stockage	[Kg.]	7	12	4	9	16	16	25	40	40	55
<b>Potencia</b> Power Puissance	[W]	-	-	260	320	340	340	450	590	700	890
<b>Refrigerante</b> Refrigerant Gaz	<b>R290</b>	HFC	<b>R290</b>								
<b>Opcional</b> Optional Options	-	Gas refrigerante HFC / Refrigerant gas HFC / Gaz réfrigérant HFC [Mod. FHC 130 AHC, FHC 155 AHC] Cubito 60gr [consultar] / Cube 60gr [consult] / Glaçon 60gr [consultar]									

**Producción en condiciones óptimas: temperatura ambiente 21°C, temperatura agua 15°C.**  
**Production in optimum conditions: room temperature 21°C, water temperature 15°C.**

**Production dans des conditions optimales: température ambiante 21°C, température de l'eau 15°C.**

**Fabricador de hielo cubito macizo /**  
Ice maker solid ice cube /  
Machines à glaçons solides

**Serie / Series / Série FHCM/SPLIT Ice Cube**

FHCM300A/W



FHCM150AHC/W



**Serie CM-Modular: cubito macizo sin almacén**  
CM-Modular Series: solid ice cube without storage  
Série CM-Modulaire: glaçon entier sans stockage

**Serie CM-Split: cubito macizo sin unidad condensadora**  
CM-Split Series: solid ice cube without condensed unit  
Série CM-Split: glaçon entier sans unité de condensation

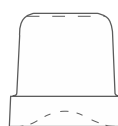

42 gr  
42x39x43 mm

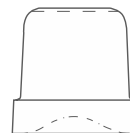

60 gr  
43x45x51 mm

FABRICADOR/ICEMAKER/MACHINE À GLAÇONS

MODULAR

SPLIT

MODELO/MODELE/MODÈLE	FHC130AHC	FHC155AHC	FHCM150AHC FHCM150W	FHCM300A FHCM300W	FHCM300S SPLIT
<b>Precio</b> Price Prix					
<b>Medidas</b> Measures (mm) Mesures	840 740 1075	840 740 1075	862 555 720	1250 580 848	990 585 850
<b>Tensión/Frecuencia</b> Electrical data (V/Hz) Tension électrique	220V-240V/50Hz				
<b>Material</b> Material Matériel	AISI 304				
<b>Condensación</b> Condensation Condenseur	Aire Air Air	Aire Air Air	Aire / Agua Air / Water Air / Eau	Aire / Agua Air / Water Air / Eau	Sin unidad condensadora Without condensed unit Sans unité de condensation
<b>Cubito</b> Cubes Glaçons (gr)	42	42	42	42	42
<b>Producción</b> Production (Kg/24h) Compresseur	134	152	155	300	300
<b>Depósito compatible</b> Compatible deposit Dépôt compatible	65	65	DI200 / DPE240 / DI350	DI350	DI350
<b>Potencia</b> Power Puissance (W)	1250	1260	1260/1400	2600	200
<b>Refrigerante</b> Refrigerant Gaz	<b>R290</b>		<b>R290</b> / HFC	HFC	HFC
<b>Opcional</b> Optional Options	Gas refrigerante HFC / Refrigerant gas HFC / Gaz réfrigérant HFC		[FHCM150] Gas refrigerante HFC / Refrigerant gas HFC / Gaz réfrigérant HFC Cubito 60gr [consultar] / Cube 60gr [consult] / Glaçon 60gr [consulter]		

**Producción en condiciones óptimas: temperatura ambiente 21°C, temperatura agua 15°C.**  
Production in optimum conditions: room temperature 21°C, water temperature 15°C.  
Production dans des conditions optimales: température ambiante 21°C, température de l'eau 15°C.



**Fabricador de hielo cubito cuadrado /  
Ice maker solid square cube /  
Machines à glaçons carré**

**Serie / Series / Série FHC B-Qube**



FHC30BQAHC/WHC



FHC45BQAHC/WHC



FHC90BQAHC/WHC



**Serie B-Qube: cubito macizo cuadrado**  
B-Qube Series: Solid square cube  
Séries B-Qube: bloc glaçon carré

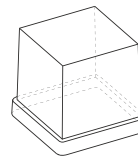

23 gr  
32.5x31.5 mm

MODELO/MODELE/MODÈLE	FHC30BQAHC FHC30BQWHC	FHC35BQAHC FHC35BQWHC	FHC40BQAHC FHC40BQWHC	FHC45BQAHC FHC45BQWHC	FHC65BQAHC FHC65BQWHC	FHC90BQAHC FHC90BQWHC
<b>Precio</b> Price Prix						
<b>Medidas</b> Measures [mm] Mesures	390 460 690	497 592 687	497 592 687	500 580 800	738 600 920	738 600 1020
	Medidas sin patas / Measurements without legs / Dimensions sans pieds Patas regulables / Adjustable legs / Pieds réglables (110-150mm)					
<b>Tensión/Frecuencia</b> Electrical data [V/Hz] Tension électrique	220V-240V/50Hz					
<b>Material</b> Material Matériel	AISI 304					
<b>Condensación</b> Condensation Condenseur	Aire / Agua Air / Water Air / Eau					
<b>Cubito</b> Cubes [gr] Glaçons	23					
<b>Producción</b> Production [Kg/24h] Compresseur	29	38	42	48	72	90
<b>Almacén</b> Warehouse [Kg.] Stockage	9	16	16	25	40	55
<b>Potencia</b> Power [W] Puissance	320	340	455	450	620	890
<b>Refrigerante</b> Refrigerant Gaz	R290					
<b>Opcional</b> Optional Options	-					

**Producción en condiciones óptimas: temperatura ambiente 21°C, temperatura agua 15°C.**

**Production in optimum conditions: room temperature 21°C, water temperature 15°C.**

**Production dans des conditions optimales: température ambiante 21°C, température de l'eau 15°C.**

**Fabricador de hielo hueco /**  
**Hollow ice maker /**  
**Machines à glaçons creux**

**Serie / Series / Série IMF**



IMF28AHC/IMF28WHC



IMF35AHC/IMF35WHC



IMF58AHC/IMF58WHC



**Serie IMF: cubito hueco**  
**IMF Series: hollow cube**  
**Séries IMF: glaçon creux**



20 gr  
 29 Ø x 45 mm    12 Ø x 36,5 mm

MODELO/MODELE/MODÈLE	IMF26AHC IMF26WHC	IMF28AHC IMF28WHC	IMF35AHC IMF35WHC	IMF58AHC IMF58WHC	IMF80AHC IMF80WHC
<b>Precio</b> Price Prix					
<b>Medidas</b> Measures Mesures (mm)	385 468 607	385 468 687	495 580 687	495 580 797	735 596 907
	- Medidas sin patas / Measurements without legs / Dimensions sans pieds Patas regulables / Adjustable legs / Pieds réglables [110-150mm]				
<b>Tensión/Frecuencia</b> Electrical data Tension électrique [V/Hz]	220V-240V/50Hz				
<b>Material</b> Material Matériel	AISI 304				
<b>Condensación</b> Condensation Condenseur	Aire / Agua Air / Water Air / Eau				
<b>Cubito</b> Cubes Glaçons (gr)	20				
<b>Producción</b> Production Compresseur (Kg/24h)	22	22	38	46	85
<b>Almacén</b> Warehouse Stockage (Kg.)	4	8	15	20	30
<b>Potencia</b> Power Puissance (W)	300	300	275	315	500
<b>Refrigerante</b> Refrigerant Gaz	<b>R290</b>				
<b>Opcional</b> Optional Options	Gas refrigerante HFC / Refrigerant gas HFC / Gaz réfrigérant HFC				

**Producción en condiciones óptimas: temperatura ambiente 21°C, temperatura agua 15°C.**  
**Production in optimum conditions: room temperature 21°C, water temperature 15°C.**  
**Production dans des conditions optimales: température ambiante 21°C, température de l'eau 15°C.**

Los datos técnicos están sujetos a posibles variaciones que serán actualizadas periódicamente en las fichas técnicas del producto, disponibles en la web /  
 The technical data are subject to possible variations that will be updated periodically in the technical data sheets of the product, which are available on the website /  
 Les données techniques peuvent varier et seront actualisées dans les fiches techniques du produit, disponibles sur le site web.



**Fabricador de hielo troceado Pebbles (coctelería) /**  
**Pebbles ice maker /**  
**Machines à ice en morceau**



FHTB90AHC/WHC



FHTB57AHC/WHC



**HIELO TROCEADO PEBBLES / PEBBLES ICE / GLACE EN MORCEAU PEBBLES**

**Serie TB: hielo troceado con almacén**

TB Series: pebbles ice with storage

Séries TB: ice en morceau avec storage

**Serie TBM-Modular: hielo troceado sin almacén**

TBM-Modular Series: pebbles ice without storage

Série TBM-Modular: Ice en morceau sans storage

MODELO/MODELE/MODÈLE	FHTB57AHC FHTB57WHC	FHTB90AHC FHTB90WHC	FHTB93AHC FHTB93WHC	FHTB142AHC FHTB142WHC	FHTB146AHC FHTB146WHC	FHTBM140AHC FHTBM140WHC	FHTBM250AHC FHTBM250WHC	FHTBM450AHC FHTBM450WHC	
<b>Precio</b> Price Prix									
<b>Medidas</b> Measures (mm) Mesures	450 620 680	500 660 690	500 660 800	738 690 851,5	738 690 1020	560 569 600	560 569 600	560 569 600	
	Medidas sin patas / Measurements without legs / Dimensions sans pieds Patas regulables / Adjustable legs / Pieds réglables (110-150mm)								
<b>Tensión/Frecuencia</b> Electrical data [V/Hz] Tension électrique	220V-240V/50Hz								
<b>Material</b> Material Matériel	AISI 304								
<b>Condensación</b> Condensation Condenseur	Aire / Agua Air / Water Air / Eau								
<b>Producción</b> Production [Kg/24h] Compresseur	57	90	90	142	146	130	245	375	
<b>Almacén</b> Warehouse [Kg.] Stockage	10	20	30	40	50	-			
<b>Depósito compatible</b> Compatible deposit Dépôt compatible	-					DPE240/ DI110 DI200/RB1100	DPE240/DI110/ DI200/ DI350/ DI350/RB1100 DRB1100	DPE240/DI110/DI200/ DI350/DI550/RB1100/ DRB1100/DRB1500/ DRB1200	
<b>Potencia</b> Power [W] Puissance	410	440	440	720	720	700	1050	1415	
<b>Refrigerante</b> Refrigerant Gaz	<b>R290</b>								
<b>Opcional</b> Optional Options	Gas refrigerante HFC / Refrigerant gas HFC / Gaz réfrigérant HFC								



Serie / Series / Série **FHTB / FHTBM PEBBLES**

+Info: [www.infrico.com](http://www.infrico.com)



FHTB142AHC/WHC



FHTB146AHC/WHC



FHTBM450AHC/TM450AHC



**Fabricador de hielo troceado /**  
**Cubed ice maker /**  
**Machines à glace en morceau**

**Serie / Series / Série FHT / FHTM Ice Flakes**



**FHT155AHC/WHC**

**Serie T: hielo troceado con almacén**  
 T Series: cubed ice with storage  
 Séries T: glace en morceau avec stockage



**FHTM160AHC/WHC**  
**FHTM280AHC/WHC**  
**FHTM510AHC/WHC**



**FHTM1000A/W**

**Serie TM-Modular: hielo troceado sin almacén**  
 TM-Modular Series: cubed ice without storage  
 Série TM-Modular: glace en morceau sans stockage



**HIELO TROCEADO / CUBED ICE / GLACE EN MORCEAU**

MODELO/MODELE/MODÈLE	FHT60AHC FHT60WHC	FHT90AHC FHT90WHC	FHT155AHC FHT155WHC	FHTM160AHC FHTM160WHC	FHTM280AHC FHTM280WHC	FHTM510AHC FHTM510WHC	FHTM1000A/W
<b>Precio</b> Price Prix							
<b>Medidas</b> Measures [mm] Mesures	450 620 680	500 660 800	738 690 1020	560 569 600	560 569 695	560 569 695	934 684 700
	Medidas sin patas / Measurements without legs / Dimensions sans pieds Patatas regulables / Adjustable legs / Pieds réglables (110-150mm)						
<b>Tensión/Frecuencia</b> Electrical data [V/Hz] Tension électrique	220V-240V/50Hz						400-415V/3N/50Hz
<b>Material</b> Material Matériel	AISI 304						
<b>Condensación</b> Condensation Condenseur	Aire / Agua Air / Water Air / Eau						
<b>Producción</b> Production [Kg/24h] Compresseur	67	113	153	157	280	435	1000
<b>Almacén</b> Warehouse [Kg.] Stockage	9	30	55	-			
<b>Depósito compatible</b> Compatible deposit Dépôt compatible	-			DPE240/ DI110 DI200/RBI100	DPE240/DI110/ DI200/ DI350/ DI550/RBI100 DRBI100	DPE240/DI110/ DI200/ DI350/ DI550/RBI100 DRBI100/DRBI500	DI550/ DRBI500
<b>Potencia</b> Power [W] Puissance	400	470	700	830	1100	1400	3200
<b>Refrigerante</b> Refrigerant Gaz	<b>R290</b>						HFC
<b>Opcional</b> Optional Options	Gas refrigerante HFC / Refrigerant gas HFC / Gaz réfrigérant HFC						

**Producción en condiciones óptimas: temperatura ambiente 21°C, temperatura agua 15°C.**  
 Production in optimum conditions: room temperature 21°C, water temperature 15°C.  
 Production dans des conditions optimales: température ambiante 21°C, température de l'eau 15°C.

**Fabricador de hielo troceado /**  
**Cubed ice maker /**  
**Machines à glace en morceau**

**Serie / Series / Série FHTM/SPLIT Ice Flakes**



**HIELO TROCEADO**  
**CUBED ICE**  
**GLACE EN MORCEAU**

**Serie SPLIT: hielo troceado sin unidad condensadora**  
**SPLIT Series: ice divided without condensed unit**  
**Séries SPLIT: glace en morceaux sans unité de condensation**



FHTM1000S SPLIT

MODELO/MODELE/MODÈLE	FHTM510S SPLIT	FHTM1000S SPLIT
<b>Precio</b> Price Prix		
<b>Medidas</b> Measures [mm] Mesures	560 569 695	765 600 695
<b>Tensión/Frecuencia</b> Electrical data [V/Hz] Tension électrique	220V-240V/50Hz	
<b>Material</b> Material Matériel	AISI 304	
<b>Condensación</b> Condensation Condenseur	Sin unidad condensadora Without condensed unit Sans unité de condensation	
<b>Producción</b> Production [Kg/24h] Compresseur	510	1000
<b>Depósito compatible</b> Compatible deposit Dépôt compatible	DPE240 / DI200 / DI350 / DI550 RBI100 / DRBI100 / DRBI500	DI550 / DRBI500
<b>Potencia</b> Power [W] Puissance	175	350
<b>Potencia frigorífica</b> Refrigerating Power [W -18°C] Puissance frigorifique	2300 [evap.temp.-18°C]	4600 [evap.temp.-18°C]
<b>Refrigerante</b> Refrigerant Gaz	HFC	
<b>Opcional</b> Optional Options	 Modelos Split para gas refrigerante R744 [CO2] ( FHT700SC02 [720 kg], FHTM1400SC02 [1400 kg] ) Split models for refrigerant R744 [CO2] (FHT700SC02 [720kg], FHTM1400SC02 [1400kg]) Modèles split pour gaz R744 [CO2] (FHT700SC02 [720kg], FHTM1400SC02 [1400kg])	

**Producción en condiciones óptimas: temperatura ambiente 21°C, temperatura agua 15°C.**  
**Production in optimum conditions: room temperature 21°C, water temperature 15°C.**  
**Production dans des conditions optimales: température ambiante 21°C, température de l'eau 15°C.**



**Fabricador de hielo escama plana /  
Ice maker flat flakes /  
Machines à ice à pailletes**

**Serie / Series / Série FHES Cold Flakes**



FHESM400A/W



FHESM2200A



FHESM 5000A

**Serie ES-Modular: hielo en escama plana sin almacén**  
ES-Modular Series: Flat flake ice without storage  
Séries ES-Modular: ice à pailletes sans storage



**HIELO EN ESCAMA  
FLAKE ICE  
GLACE À PAILLETES**

MODELO/MODELE/MODÈLE	FHESM250A FHESM250W	FHESM400A FHESM400W	FHESM600A FHESM600W	FHESM900A FHESM900W	FHESM1500A FHESM1500W	FHESM2200A -	FHESM5000A -
<b>Precio</b> Price Prix							
<b>Medidas</b> Measures [mm] Mesures	870 550 600	900 588 705	900 588 705	1107 700 880	1107 700 970	1062 832 1423	1270 1400 1620
<b>Tensión/Frecuencia</b> Electrical data [V/Hz] Tension électrique	220V-240V/50Hz			400V-415V//3N/50Hz			
<b>Material</b> Material Matériel	AISI 304						
<b>Condensación</b> Condensation Condenseur	Aire / Agua Air / Water Air / Eau					Aire Air Air	
<b>Producción</b> Production [Kg/24h] Compresseur	250	400	620	900	1500	2300	5000
<b>Almacén</b> Warehouse [Kg.] Stockage	-						
<b>Depósito compatible</b> Compatible deposit Dépôt compatible	D1200 D1350	D1350 D1550 DRBI100	D1350 D1550 DRBI100/DRBI500	D1550 DRBI500	D1550 DRBI500	-	
<b>Potencia</b> Power [W] Puissance	1700	2100	3000	4600	6000	7000	16000
<b>Refrigerante</b> Refrigerant Gaz	HFC						
<b>Opcional</b> Optional Options	-						

**Producción en condiciones óptimas: temperatura ambiente 21°C, temperatura agua 15°C.**

Production in optimum conditions: room temperature 21°C, water temperature 15°C.

Production dans des conditions optimales: température ambiante 21°C, température de l'eau 15°C.

**Fabricador de hielo escama plana /**  
Ice maker flat flakes /  
Machines à ice à pailletes

**Serie / Series / Série FHESM/SPLIT Cold Flakes**



FHESM5000S SPLIT



FHESM400S a 2200S SPLIT

**Serie ES-SPLIT: hielo en escama plana sin unidad condensadora**  
ES-SPLIT Series: Flat flake ice without condensed unit  
Séries ES-SPLIT: ice à pailletes sans unité de condensation



**HIELO EN ESCAMA**  
**FLAKE ICE**  
**GLACE À PAILLETES**

MODELO/MODELE/MODÈLE FHESM400S SPLIT FHESM600S SPLIT FHESM900S SPLIT FHESM1500S SPLIT FHESM2200S SPLIT FHESM5000S SPLIT

<b>Precio</b> Price Prix						
<b>Medidas</b> Measures [mm] Mesures	495 588 705	495 588 705	604 700 880	604 700 970	736 832 1075	1270 1015 1076
<b>Tensión/Frecuencia</b> Electrical data [V/Hz] Tension électrique	220V-240V/50Hz				400V-415V//3N/50Hz	
<b>Material</b> Material Matériel	AISI 304					
<b>Condensación</b> Condensation Condenseur	Sin unidad condensadora Without condensed unit Sans unité de condensation					
<b>Producción</b> Production [Kg/24h] Compresseur	400	620	900	1500	2300	5000
<b>Depósito compatible</b> Compatible deposit Dépôt compatible	DI350 / DI550 DRBI100	DI350 / DI550 DRBI100 / DRBI500	DI550 / DRBI500	DI550 / DRBI500	-	-
<b>Potencia</b> Power [W] Puissance	180				360	
<b>Potencia frigorífica</b> Refrigerating Power [W -18°C] Puissance frigorifique	2200W [evap.temp. -23°C]	3500W [evap.temp. -22°C]	5000W [evap.temp. -23°C]	8550W [evap.temp. -24°C]	12000W [evap.temp. -27°C]	25000W [evap.temp. -27°C]
<b>Refrigerante</b> Refrigerant Gaz	HFC					
<b>Opcional</b> Optional Options	 Modelos Split para gas refrigerante R744 [CO2] (FHESM600SCO2 [620 kg], FHESM900SCO2 [1040kg], FHESM1500SCO2 [1520kg]). Split models for refrigerant R744 [CO2] (FHESM600SCO2 [620 kg], FHESM900SCO2 [1040kg], FHESM1500SCO2 [1520kg]). Modèles split pour gaz R744 [CO2] (FHESM600SCO2 [620 kg], FHESM900SCO2 [1040kg], FHESM1500SCO2 [1520kg]).					

**Producción en condiciones óptimas: temperatura ambiente 21°C, temperatura agua 15°C.**  
Production in optimum conditions: room temperature 21°C, water temperature 15°C.  
Production dans des conditions optimales: température ambiante 21°C, température de l'eau 15°C.

Los datos técnicos están sujetos a posibles variaciones que serán actualizadas periódicamente en las fichas técnicas del producto, disponibles en la web /  
The technical data are subject to possible variations that will be updated periodically in the technical data sheets of the product, which are available on the website /  
Les données techniques peuvent varier et seront actualisées dans les fiches techniques du produit, disponibles sur le site web.



**Almacén fabricante de hielo /**  
Ice maker storage /  
Stockage pour machine à glaçons

Serie / Series / Série **DPE/DI**



DPE240



DI200



DI350



DI550

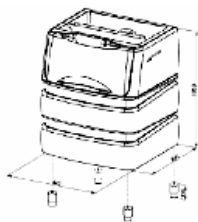

DPE240

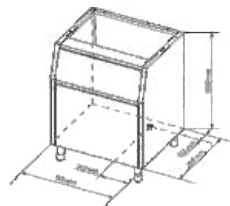

DI200

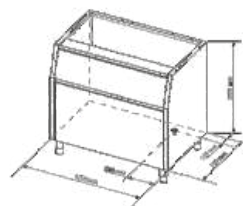

DI350

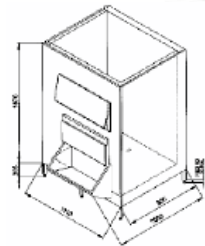

DI550

MODELO/MODELE/MODÈLE	DPE240	DI110	DI200	DI350	DI550
<b>Precio</b> Price Prix					
<b>Medidas</b> Measures (mm) Mesures	942 795 1053	560 815 1000	870 790 1000	1250 790 1000	1110 1060 1915
	Medidas sin patas / Measurements without legs / Dimensions sans pieds Patas regulables / Adjustable legs / Pieds réglables (110-160mm)				
<b>Material</b> Material Matériel	Depósito: polietileno / Storage: polyethylene / Stockage: polyéthylène		Depósito / Storage / Stockage: AISI 304		
<b>Almacén</b> Warehouse Stockage (Kg.)	-				
<b>Reserva</b> Reserve Réserve	180	100	200	350	550
<b>Fabricador</b> Manufacturer Machine à glaçons	CM150 / TM160 TM280 / TM510 TM510 SPLIT FHTBM140 / FHTBM250 FHTBM450	TM160 / TM280 TM510 / TM510 SPLIT FHTBM140 FHTBM250 FHTBM450	CM150 / TM160 TM280 / TM510 TM510 SPLIT / ESM250 FHTBM140 / FHTBM250 FHTBM450	CM150 / CM300 / CM300 SPLIT TM280 / TM510 / TM510 SPLIT ESM250 / ESM400 ESM600 FHTBM250 / FHTBM450	TM510 (2) / TM510 (2) SPLIT TM1000 / TM1000 SPLIT ESM400 / ESM600 / ESM900 ESM1500 / ESM1500 SPLIT FHTBM250 / FHTBM450
<b>Opcional</b> Optional Options	-				

**Almacén de hielo /**  
Ice storage /  
Stockage pour glaçons

**Serie / Series / Série ROLLER BIN**  
**DOBLE ROLLER BIN**



DRBI100



DRBI1200



RBI100



DRBI500

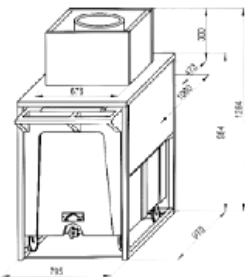

RBI100

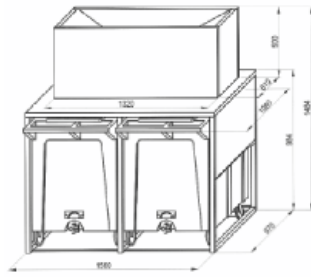

DRBI100

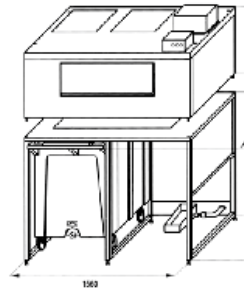

DRBI500

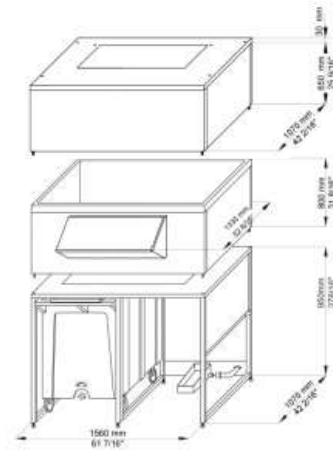

DRBI1200

MODELO/MODELE/MODÈLE	RBI100	DRBI100	DRBI500	DRBI1200
<b>Precio</b> Price Prix				
<b>Medidas</b>  Measures [mm] Mesures	795 1060 1284	1560 1060 1484	1560 1330 1810	1560 1330 2460
<b>Material</b> Material Matériel	Depósito / Storage / Stockage: AISI 304 Contenedor polietileno / Container in polyethylene / Container en polyéthylène			
<b>Almacén</b> Warehouse Stockage [Kg.]	17	50	300	1000
<b>Reserva</b> Reserve Réserve	108	108+108	108+108	108+108
<b>Fabricador</b> Manufacturer Machine à glaçons	FHTM160 FHTM280 FHTM510 / FHTM510 SPLIT FHTBM250 / FHTBM450	FHTM280 / FHTM510 FHESM400 / FHESM600 FHESM400 SPLIT / FHESM600 SPLIT FHTBM140 / FHTBM250 FHTBM450	FHTM510 (2) / FHTM510 SPLIT (2) FHTM1000 / FHTM1000 SPLIT FHESM600 / FHESM600 SPLIT FHESM900 / FHESM900 SPLIT FHESM1500 / FHESM1500 SPLIT FHTBM450	FHTM510 (2) / FHTM510 SPLIT (2) FHTBM450 FHESM600 / FHESM600 SPLIT FHESM900 SPLIT
<b>Opcional</b> Optional Options				



# Lavavasos y lavaplatos / Glasswasher, dishwasher and hood dishwasher / Lave-vaisselle

## A DESTACAR

Estructura interior y exterior en acero inoxidable.  
Puerta construida en doble pared.  
Guías cesta embutidas, modelos LVP2535, LVP3040 y LVP3250.  
Brazos de lavado inferior en acero inoxidable y superior en composite.  
Cuba con fondo embutido, dotado con filtro en toda la anchura de la cuba.  
Modelo LVP3040 con lavado superior giratorio.  
Brazos de aclarado en composite.  
Bombas de lavado con sistema DuoFlo excepto en el modelo LV2535, sistema de bomba con una entrada y dos salidas, de esta forma se elimina la perdida de potencia y el ruido disminuye, mejora el rendimiento y disminuye el consumo de energía, excepto en el modelo LV2535.  
Dosificador de abrillantador peristáltico con regulación electrónica al igual que el dosificador detergente [opcional].  
Modelos con Bomba desagüe [BD] con descarga parcial, durante el aclarado se introduce agua limpia en la cuba para sustituir la sucia, se realizan aportaciones continuas de agua limpia, cuando termina el ciclo de lavado parte del agua de la cuba ha sido renovada.  
Garantizamos un caudal en litros constantes en el aclarado independientemente de la presión del agua de red.  
Mesas de entrada y salida, mesa prelavado, etc.

## BENEFITS

Interior and exterior structure in stainless steel.  
Door made of double wall.  
Embossed rack's drives, models LVP2535, LVP3040 y LVP3250.  
Lower wash arms in stainless steel and upper composite.  
Welded tank, equipped with filter for the entire width of the tank.  
Model LVP3040 with rotatory top wash.  
Composite rinse arms.  
Wash pumps with the DuoFlo system except the model LV2535, pump system with one inlet and two outlets, this eliminates energy loss and noise decreases, improves performance and reduces energy consumption except in the model LV2535.  
Dosing of peristaltic rinse aid with electronic regulation as well as dosage detergent [optional].  
Models with drain pump [BD] with the partial discharge, during the rinse introduce the clean water in the tank to replace the dirty, continuous contributions of clean water are made, when the washing cycle is finished part of the water of the tank has been renewed.  
We guarantee a flow in constant liters in the rinsing regardless of the water pressure of network.  
Tables of entrance and exit, prewash table, etc.

## À SOULIGNER

Structure intérieure et extérieure en acier inoxydable.  
Porte construite en double paroi. Bras de lavage inférieurs en acier inoxydable et composite supérieur.  
Modèle LVP3040 avec lavage supérieur.  
Bras de rinçage composite.  
Nouvelle carte électronique commune pour toute la gamme, avec connexion USB pour sa mise à jour et sa programmation.  
Sur l'écran il est possible d'afficher la température de lavage et de rinçage, ainsi que codes d'erreur.  
ProSelf programme d'auto-nettoyage à effectuer à la fin de la journée.  
Possibilité de régler les feeders de produits à travers la plaque chimique.  
Pompes de lavage avec système DuoFlo sauf pour le modèle LV2535, système pompe avec une entrée et deux sorties, ainsi on évite la perte de puissance et le bruit diminue, améliore la performance et diminue la consommation d'énergie, sauf dans le modèle LV2535.  
Dosage du liquide de rinçage électroniquement comme le dosage du produit de lavage [option].  
Modèles avec pompe de vidange [BD] à décharge partielle, pendant le rinçage de l'eau propre est introduite dans le réservoir pour remplacer l'eau sale, distribution en continu d'eau propre, à la fin du cycle de lavage une partie de l'eau dans le réservoir a été renouvelée.  
Nous garantissons un débit en litres constante pendant le rinçage indépendamment de la pression de l'eau du réseau.





Serie / Series / Série **ELECTROMECÁNICA**  
**ELECTROMECHANICAL**  
**ÉLECTROMÉCANIQUE**

+Info: [www.infrico.com](http://www.infrico.com)



LCP4550



**Lavavasos y lavaplatos /**  
Glasswasher, dishwasher and hood dishwasher /  
Lave-vaisselle



LVP3040



LVP3250

Serie / Series / Série **ELECTROMECAÁNICA**  
**ELECTROMECHANICAL**  
**ÉLECTROMÉCANIQUE**

+Info: [www.infrico.com](http://www.infrico.com)



**Brazo lavado y aclarado superior modelo LVP3250**  
Upper washing and rising arm model LVP3250  
Bras supérieur de lavage et de rinçage, modèle LVP3250



**Bomba de lavado DuFlo**  
Washing pump DuFlo  
Pompe de lavage DuFlo

MODELO/MODELE/MODÈLE	LV2535 LV2535 BD	LVP3040 LVP3040 BD	LVP2845 LVP2845 BD	LVP3250 LVP3250 BD LVP3250 DBD	LCP4550 LCP4550 BD LCP4550 DBD
<b>Precio</b> Price Prix					
<b>Medidas</b> Measures [mm] Mesures	401x490x595	436x535x670	525x555x715	575x605x820	724x818x1529 (2010)
<b>Medidas de cesta</b> Rack measures [mm] Mesures de panier	350x350	400x400	450x450	500x500	500x500
<b>Altura útil de lavado</b> Washing height [mm] Hauteur utile de lavage	250	300	280	325	425/440
<b>Ciclos de lavado estándar</b> Standard washing cycles Durée du cycle	120	120	120	90/150	90/150
<b>Producción horaria</b> Hourly production Production horaire	30	30	30	40/24	40/24
<b>Tensión/Frecuencia</b> Electrical data [V/Hz] Tension électrique	230/50/1N	230/50/1N	230/50/1N	230/50/1N	400/50/3N
<b>Material</b> Material Matériel	AISI 304				
<b>Potencia Máx. funcionam.</b> Max. operating power [W] Puissance maximale	3500				8500
<b>Pot. resistencia cuba</b> Power tank resist. [W] Puiss. résist. cuvette	600			2100	
<b>Pot. resist. boiler</b> Boiler resist. power [W] Puiss. résist. boiler	2600			3000	8000
<b>Pot. bomba lavado</b> Whash. pump power [W] Puiss. bombe lavé	150	200		470	
<b>Temp. Lavado/Aclar.</b> Wash/rinse temp. [°C] Temp. lavage/rinçage	60°C/80°C				
<b>Capacidad cuba/boiler</b> Tank/boiler capacity [L] Capacité cuvette	7/2,6	9/2,6	14/2,6	20/6	15/6
<b>Consumo agua x cesta</b> Water/rack consumpt. [L] Consomat. eau x panier	1,8			2,2	
<b>Dotación</b> Endowment Dotation	2 Cestos vasos, 1 contenedor cubiertos, 1 insertador platos 2 glass racks, 1 storage cutlery, 1 plate inserter 2 paniers à verre, 1 bac couverts, 1 range assiettes	2 Cestos, 1 contenedor cubiertos, 1 insertador platos 2 Racks, 1 storage cutlery, 1 plats inserter 2 paniers, 1 bac couverts, 1 range assiettes	1 Cesto vasos/1 platos, 1 contenedor cubiertos, 1 insertador platos 1 Glass rack/1 plats, 1 storage cutlery, 1 plats inserter 1 panier à verre/1 assiettes, 1 bac couverts, 1 range assiettes	1 Cesto vasos, 1 cesto platos, 1 contenedor cubiertos 1 Glass rack, 1 rack plats, 1 storage cutlery 1 panier à verre, 1 range assiettes, 1 bac couverts	
<b>Opcional</b> Optional Options	<b>Kit dosificador detergente / Detergent dispenser kit / Kit doseur détergent</b> <b>Kit bomba desagüe sin descarga parcial / Drainage pump kit without partial discharge / Kit pompe de vidange sans décharge partielle</b>				
	-	230V/1N/60Hz	-	230V/1N/60Hz	400V/3N/60Hz
	-	-	-	-	<b>Recuperador de calor LCP4550 DBD RC</b>



# Lavavasos y lavaplatos / Glasswasher, dishwasher and hood dishwasher / Lave-vaisselle

## A DESTACAR

Estructura interior y exterior en acero inoxidable.

Puerta construida en doble pared.

Guía cesta estampada y embutida, modelos LVP3040E y LVP3250E.

Cuba con fondo embutido, dotado con filtro en toda la anchura de la cuba.

Brazos de lavado inferior en acero inoxidable y superior en composite, excepto en la gama de lavaplatos Cúpula que ambos son en acero inox.

Modelo LVP3040E con lavado superior giratorio.

Brazos de aclarado en composite.

Bombas de lavado con sistema DuoFlo, sistema de bomba con una entrada y dos salidas, de esta forma se elimina la pérdida de potencia y el ruido disminuye, mejora el rendimiento y disminuye el consumo de energía.

Todos los modelos con dosificador de detergente de serie.

Dosificador de abrillantador peristáltico con regulación electrónica.

Modelos con Bomba desagüe [BD] con descarga parcial.

Nueva placa de electrónica común para toda la gama, con conexión USB para su actualización y programación.

En el Display posibilidad de visionar temperatura de lavado y aclarado, códigos de errores, así como programas y fases del programa.

Cinco programas de lavado, con posibilidad de modificar tiempos.

Tres programas de tiempos 60, 120 y 150 segundos, lavado continuo y programa de auto limpieza ProSelf a realizar al final de la jornada.

Descarga automática en los modelos con bomba desagüe [BD] con descarga parcial.

Posibilidad de regular a través de la placa los dosificadores de producto químico.

Modelos con recuperador de calor, incluye bomba de Aclarado y bomba Descarga Parcial [BD]

## BENEFITS

Embossed rack's drives, models LVP3040E y LVP3250E.

Welded tank, equipped with filter for the entire width of the tank. Interior and exterior structure in stainless steel.

Door made of double wall.

Lower wash arms in stainless steel and upper in composite, except in the range of dishwasher Dome that both are in stainless steel.

Model LVP3040E with rotatory top wash. Composite rinse arms.

Wash pumps with DuoFlo system, pump system with one inlet and two outlets, this eliminates loss of power and noise decreases, improves performance and decreases energy consumption.

All models with dosage detergent as standard.

Dosing of peristaltic rinse aid with electronic regulation.

Models with drain pump [BD] with partial discharge.

New common electronics board for the whole range, with USB connection for updating and programming.

In the Display it is possible to view wash and rinse temperature, error codes as well as programs and program phases.

Five washing programs, with the possibility of changing times.

Three 60, 120 and 150 second time programs, continuous washing and ProSelf self cleaning program to be performed at the end of the day and automatic discharge in the models with partial discharge drain [BD].

Possibility of regulating through the plate the chemical dosificadores.

Models with heat recovery, including Rinse pump and Partial Discharge pump [BD].

## Á SOULIGNER

Structure intérieure et extérieure en acier inoxydable.

Porte construite en double paroi.

Bras de lavage inférieurs en acier inoxydable et composite supérieur.

Modèle LVP3040 avec lavage supérieur.

Bras de rinçage composite.

Nouvelle carte électronique commune pour toute la gamme, avec connexion USB pour sa mise à jour et sa programmation.

Sur l'écran il est possible d'afficher la température de lavage et de rinçage, ainsi que les codes d'erreur.

ProSelf programme d'auto-nettoyage à effectuer à la fin de la journée.

Possibilité de réguler les doses de produit chimique.

Sur l'écran il est possible d'afficher la température de lavage et de rinçage, ainsi que codes d'erreur.

ProSelf programme d'auto-nettoyage à effectuer à la fin de la journée.

Possibilité de régler les feeders de produits à travers le contrôle électronique.

Pompes de lavage avec système DuoFlo sauf pour le modèle LV2535, système pompe avec une entrée et deux sorties, ainsi on évite la perte de puissance et le bruit diminue, améliore la performance et diminue la consommation d'énergie, sauf dans le modèle LV2535.

Tous les modèles avec dosage du produit de lavage à série.

Dosage du liquide de rinçage électroniquement.

Modèles avec pompe de vidange [BD] à décharge partielle, pendant le rinçage de l'eau propre est introduite dans le réservoir pour remplacer l'eau sale, distribution en continu d'eau propre, à la fin du cycle de lavage une partie de l'eau dans le réservoir a été renouvelée.

Nous garantissons un débit en litres constant pendant le rinçage indépendamment de la pression de l'eau du réseau.

Modèles avec récupération de chaleur, y incluant la pompe de rinçage et la pompe à décharge partielle [BD].



Serie / Series / Série **ELECTRÓNICA**  
**ELECTRONIC**  
**ÉLECTRONIQUE**

+Info: [www.infrico.com](http://www.infrico.com)

LCP4550ED



**Lavavasos y lavaplatos /**  
**Glasswasher, dishwasher and hood dishwasher /**  
**Lave-vaisselle**



**Modelo LCP4550EDBDRC con Recuperador de Calor RC**

Aspira el vapor que se forma después del aclarado y lo condensa, el calor recuperado aumenta en 25°C la temperatura del agua que entra. Se obtiene un importante ahorro de energía gracias a la reducción en casi un 40%, de la variación térmica que el boiler debe proporcionar al agua del aclarado. Se produce al final el ciclo y elimina la descarga de vapor al abrir la capota.

**Model LCP4550EDBDRC with RC Heat Recovery**

Aspirates the vapor that forms after the rinsing and condenses it, the recovered heat increases in 25°C the incoming water temperature. Significant energy savings are achieved thanks to a 40% reduction in the thermal variation that the boiler must provide to rinse water. It produces the cycle at the end and eliminates the discharge of steam when opening the canopy.

**Modèle LCP4550EDBDRC avec Récupération de chaleur RC**

Aspire la vapeur qui se forme suite au rinçage et la condense, la chaleur récupérée augmente de 25°C la température de l'eau entrante. On obtient une importante économie d'énergie grâce à la réduction (presque de 40%) de la variation thermique que le boiler doit proportionner à l'eau de rinçage.



**LVP3250ED**



Serie / Series / Série **ELECTRÓNICA**  
**ELECTRONIC**  
**ÉLECTRONIQUE**

+Info: [www.infrico.com](http://www.infrico.com)



**Capacidad bandejas**  
**600x400 o GN 1/1**  
Capacity trays  
600x400 or GN 1/1  
Capacité plateaux  
600x400 ou GN 1/1



**Cuba embutida LCP 4550E**  
Stamped pan LCP 4550E  
Cuve emboutie LCP 4550E



**Cuba LCP 4560E**  
Pan LCP4560E  
Cuve LCP 4560E

**Nomenclatura / Nomenclature / Nomenclature:**

**E: Gama electrónica / Electronic range / Gamme électronique**

**D: Dosificador detergente de serie / Detergent dosing standard / Doseur détergent de série**







**BD: Bomba desagüe parcial de serie / Partial discharge pump standard / Pompe à vidange partielle de série**

**RC: Recuperador de calor / Heat recovery system / Récupération de chaleur**

MODELO/MODELE/MODÈLE	LVP3040ED LVP3040EDBD	LVP3250ED LVP3250EDBD	LCP4550ED LCP4550EDBD	LCP4560ED LCP4560EDBD	LCP4550EDBDRC
<b>Precio</b> Price Prix					
<b>Medidas</b> Measures [mm] Mesures	436x535x670	575x605x820	724x818x1529 [2010]	788x835x1565 [2080]	724x818x2229
<b>Medidas de cesta</b> Rack measures [mm] Mesures de panier	400x400	500x500	500x500	600x500	500x500
<b>Altura útil de lavado</b> Washing height [mm] Hauteur utile de lavage	300	325	425 / 440	440	425 / 440
<b>Ciclos de lavado estándar</b> Standard washing cycles Durée du cycle	60/120/150 Autolimpieza/Self-cleaning/ Autonettoyant	60/120/150 Continuo/Autolimpieza / Continuous/Self-cleaning / Continu/Autonettoyant			
<b>Producción horaria</b> Hourly production Production horaire	40/30/24				
<b>Tensión/Frecuencia</b> Electrical data [V/Hz] Tension électrique	230/50/1N		400/50/3N		
<b>Material</b> Matériel	AISI 304				
<b>Potencia Máx. funcionam.</b> Max. operating power [W] Puissance maximale	3500		8700	9500	8700
<b>Pot. resistencia cuba</b> Power tank resist. [W] Puiss. résist. cuvette	600	2100	2500	2500	2500
<b>Pot. resist. boiler</b> Boiler resist. power [W] Puiss. résist. boiler	2600	3000	8000		
<b>Pot. bomba lavado</b> Whash. pump power [W] Puiss. bombe lavé	200	470	650	1500	650
<b>Temp. Lavado/Aclar.</b> Wash/rinse temp. [°C] Temp. lavage/rinçage	60°C/80°C				
<b>Capacidad cuba/boiler</b> Tank/boiler capacity [L] Capacité cuvette	9/2,6	20/6		30/6	20/12
<b>Consumo agua x cesta</b> Water/rack consumpt. [L] Consomat. eau x panier	1,8	2,2		2,6	2,2
<b>Dotación</b> Endowment Dotation	1 Cesto vasos/1 platos, 1 conten cubiertos, 1 insertador platos 1 Glass rack/1 plats, 1 storage cutlery, 1 plats inserter 1 panier à verre/1 assiettes, 1 bac couverts, 1 range assiettes		1 Cesto vasos, 1 cesto platos, 1 contenedor cubiertos 1 Glass rack, 1 rack plats, 1 storage cutlery 1 panier à verre, 1 range assiettes, 1 bac couverts		
<b>Opcional</b> Optional Options	<b>Kit bomba desagüe sin descarga parcial / Drainage pump kit without partial discharge / Kit pompe de vidange sans décharge partielle</b>				
					Serie/Serie/Série
	-	-	-	<b>Recuperador de calor LCP4560E DBD RC</b>	-









## Accesorios lavaplatos cúpula / Dishwasher accessories / Accessoires lave-vaisselles

Descripción Description Description	Medidas (mm) Measures (mm) Mesures (mm)	Imagen Image Image	Código Code Code	Precio Price Prix
<b>Mesa entrada/ salida con entrepaño 700mm</b>  Entry/ out table 700 mm  Table entrée/sortie 700 mm	700x575x850		MCP80202	
<b>Mesa con peto derecha 700mm</b>  Table right backsplash 700 mm  Table avec dosseret à droite 700 mm	700x715x850		MCP80200	
<b>Mesa con peto derecha 1200mm</b>  Table right backsplash 1200 mm  Table avec dosseret à droite 1200 mm	1200x715x850		MCP80204	
<b>Mesa con peto izquierda 700mm</b>  Table left backsplash 700 mm  Table avec dosseret à gauche 700 mm	700x715x850		MCP80201	
<b>Mesa con peto izquierda 1200mm</b>  Table left backsplash 1200 mm  Table avec dosseret à gauche 1200 mm	1200x715x850		MCP80203	
<b>Mesa con fregadero izquierda 700mm. Cuba 50x40cm</b>  Table sink left 70 mm Sink 50x40 cm  Table avec évier à gauche 700 mmCuve 50x40 cm	700x715x850		MCP80205L700	
<b>Mesa con fregadero derecha 700mm. Cuba 50x40cm</b>  Table sink right 700 mm Sink 50x40 cm  Table avec évier à droite 700 mmCuve 50x40 cm	700x715x850		MCP80206L700	



## Accesorios lavaplatos cúpula / Dishwasher accesories / Accessoires lave-vaisselles

+Info: [www.infrico.com](http://www.infrico.com)

Descripción Description Description	Medidas (mm) Measures (mm) Mesures (mm)	Imagen Image Image	Código Code Code	Precio Price Prix
<b>Mesa con fregadero izquierda 1200mm. Cuba 50x40cm</b>  Table sink left 1200 mm  Table avec évier à gauche 1200 mm. Cuve 50x40 cm	1200x715x850		MCP80205	
<b>Mesa con fregadero derecha 1200mm. Cuba 50x40cm</b>  Table sink right 1200 mm  Table avec évier à droite 1200 mm. Cuve 50x40 cm	1200x715x850		MCP80206	
<b>Mesa prelavado con fregadero y orificio izquierdo de desbrasado 1200mm. Cuba 50x40cm</b>  Prewash table sink left 1200 mm  Table pré lavage avec évier et orifice à gauche 1200 mm. Cuve 50x40 cm	1200x715x850		MCP80207	
<b>Mesa prelavado con fregadero y orificio derecho de desbrasado 1200mm. Cuba 50x40cm</b>  Prewash table sink right 1200 mm  Table pré lavage avec évier et orifice à droite 1200 mm. Cuve 50x40 cm	1200x715x850		MCP80208	
<b>Anillo de goma para desbrasado</b>  Rubber ring  Joint en caoutchouc	-		199064	
<b>Grifo ducha prelavado</b>  Prewash faucet shower  Robinet pré lavage	-		799003	
<b>Cubo residuos en inox con ruedas</b>  Waste bin inox with casters  Poubelle en inox sur roulettes	-		704002	



# Lavautensilios y lavaperolas / Dishwasher / Lave-ustensiles

## A DESTACAR

Se trata de la solución ideal para obradores de panadería, pastelería y heladería.

Estructura en doble pared en acero Inox, este diseño nos permite reducir la dispersión térmica y acústica. Obtenemos valores de dispersión térmica de más de un -60%.

Brazos de lavado y aclarado en paralelo superior e inferior en composite, excepto en los modelos LP8570 y LP85132 que son en acero inoxidable, garantizan resultados óptimos de lavado.

### Nueva placa electrónica común para todos los modelos.

Display con pantalla LCD a color, permite visionar temperatura de lavado, aclarado, códigos de errores, programas y fases del programa.

Nueve programas de lavado, cinco básicos de duración en segundos 120, 240, 360, 720, autolimpieza **ProSelf** y cuatro adicionales.

Puerto USB de conexión para actualizar el software y programación.

Diseño de la cuba con cantos redondeados y ausencia de tapón rebosadero, todos los modelos equipan bomba de desagüe, con renovación parcial del agua de lavado.

Filtro de cuba en acero inoxidable. Bombas de lavado con sistema **DuoFlo**, sistema de bomba de lavado con una entrada y dos salidas, se elimina pérdida de potencia y se consigue una disminución del ruido, mejorando el rendimiento y reduciendo el consumo a la vez que se garantiza un mejor y mayor reparto del caudal del agua de lavado.

Sistema de aclarado **UltraRinse** (presión de aclarado constante), nos permite mantener temperatura del agua constante durante la fase de aclarado, así como una presión y caudal del agua del aclarado constante independientemente de las condiciones de la red hidráulica.

De serie, dosificador de abrillantador y detergente peristálticos, con posibilidad de regularlos en el panel de mandos.

Todos los modelos equipan de serie **bomba de aclarado y bomba de desagüe** con descarga parcial, lo que significa que durante el lavado se introduce agua limpia en la cuba para sustituir la sucia, se realizan aportaciones continuas de agua limpia, cuando termina el ciclo parte del agua de la cuba ha sido renovada.

## Opcional:

Soportes bandejas, contenedor cubiertos inox, insertador en forma de embudo para confitería, etc.

**Brazos de lavado acero inoxidable**  
Stainless steel washing arm  
Bras de lavage en acier inoxydable



**Auto limpieza de la cuba**  
Self-cleaning drum  
Auto-nettoyage de la cuve



**Cuba estampada**  
Printed drum  
Cuve emboutie



## Á SOULIGNER

C'est la solution idéale pour les boulangeries, pâtisseries et magasins de crème glacée.

Structure à double paroi en acier inoxydable, cette conception nous permet de réduire la dispersion thermique et acoustique. Nous obtenons des valeurs de dispersion thermique supérieures à -60%.

Les bras de lavage et de rinçage parallèles supérieurs et inférieurs en composite, à l'exception des modèles LP8570 et LP85132, qui sont en acier inoxydable, garantissent des résultats de lavage optimaux.

### Nouvelle carte électronique commune à tous les modèles.

L'affichage avec écran LCD couleur permet de visualiser la température de lavage, le rinçage, les codes d'erreur, les programmes et les phases du programme.

Neuf programmes de lavage, cinq basiques d'une durée de 120, 240, 360, 720, auto-nettoyage **ProSelf** et quatre autres.

Port de connexion USB pour mettre à jour le logiciel et la programmation.

Conception du réservoir avec bords arrondis et absence de bouchon de trop-plein, tous les modèles équipés d'une **pompe de lavage et pompe de vidange** à série, avec renouvellement partiel de l'eau de lavage.

Filtre de réservoir en acier inoxydable.

### Gran capacidad de trabajo

High working capacity  
Grande capacité de travail



Opcional  
Optional  
Options

**Soporte 8 bandejas prof. máx. 4cm para LP (50x50cm)**  
Support 8 trays max. depth 4cm for LP (50x50cm)  
Support 8 plateaux profond. maxi 4cm pour LP (50x50cm)

**Contenedor cubiertos inox LP**  
Cutlery storage stain. steel LP  
Récipient couverts inox LP

**Insertador embudo para confitería LP**  
Funnel inserter for pastry LP  
Inserteur entonnoir à boulangerie LP

**Soporte Inox 5 bandejas para LP prof. máx. 6,5cm (50x50cm)**  
Support stainless steel 5 trays for LP max. depth 6,5cm (50x50cm)  
Support inox 5 plateaux profond. maxi 6,5 cm pour LP (50x50cm)

**Soporte para cestas LP4060**  
Rack holder LP4060  
Support pour paniers LP4060

Serie / Series / Série **LP**

+Info: [www.infrico.com](http://www.infrico.com)



MODELO/MODELE/MODÈLE	LP4060	LP6561	LP8561	LP8570	LP85132
<b>Precio</b> Price Prix					
<b>Medidas</b> Measures [mm] Mesures	600x700 [1135] x1228	719x782 [1180] x1727 [1997]	719x782 [1330] x1927 [2243]	853x857 [1400] x1959 [2274]	1465x857 [1400] x1959 [2274]
<b>Medidas de cesta</b> Rack measures [mm] Mesures de panier	500x600	550x610		700x700	1320x700
<b>Altura útil de lavado</b> Washing height [mm] Hauteur utile de lavage	405 / 380	650 / 600	850 / 800		
<b>Ciclos de lavado estándar</b> Standard washing cycles Durée du cycle	<b>9 Ciclos, 5 básicos 120, 240, 360, autolimpieza y 720</b> 9 Cycles, 5 basic cycles 120, 240, 360, self-cleaning and 720 9 Cycles, 5 basiques 120, 240, 360, autonettoyage et 720				
<b>Producción horaria</b> Hourly production Production horaire	30				
<b>Tensión/Frecuencia</b> Electrical data [V/Hz] Tension électrique	400/50/3N				
<b>Material</b> Matériel	AISI 304				
<b>Potencia Máx. funcionam.</b> Max. operating power [W] Puissance maximale	9800	7500		10700	15900
<b>Pot. resistencia cuba</b> Power tank resist. [W] Puiss. résist. cuvette	2100	3000		8000	10500
<b>Pot. resist. boiler</b> Boiler resist. power [W] Puiss. résist. boiler	7000	6000		8000	10500
<b>Pot. bomba lavado</b> Whash. pump power [W] Puiss. bombe lavé	700	1500		3000	2 x 2700
<b>Temp. Lavado/Aclar.</b> Wash/rinse temp. [°C] Temp. lavage/rinçage	55°C a 65°C/80°C a 85°C				
<b>Capacidad cuba/boiler</b> Tank/boiler capacity [L] Capacité cuvette	23/7	37/12		68/12	131/17
<b>Consumo agua x cesta</b> Water/rack consumpt. [L] Consomat. eau x panier	2,4	3		4	6
<b>Dotación</b> Endowment Dotation	1 Cesto universal inoxidable 1 Universal stainless steel rack 1 Panier universal inoxydable	1 Cesto universal inoxidable 1 Universal stainless steel rack 1 Panier universal inoxydable		1 Cesto universal inoxidable 1 Universal stainless steel rack 1 Panier universal inoxydable	1 Cesto universal inoxidable 1 Universal stainless steel rack 1 Panier universal inoxydable
<b>Opcional</b> Options	-	Recuperador de calor LP8561 RC	Recuperador de calor LP8570 RC	Recuperador de calor LCP4560E DBD RC	Recuperador de calor LP85132 RC



# Túneles de lavado y arrastre / Rack conveyor dishwasher / Tunnels de lavage

## A DESTACAR

Estructura fabricada en doble pared en acero inox, este diseño nos permite reducir el ruido y la pérdida de calor. Puertas en doble pared con aislamiento.

Altura útil de carga 450mm, nos permite lavar objetos de mayor tamaño.

Diseño realizado para facilitar su limpieza, cuba de lavado embutida sin tubos interiores con sistema de doble y triple filtro de suciedad del agua, con recogida de residuos.

Filtrado secuencial exclusivo en los modelos TA31111 y TA31112, se trata de la combinación de filtros y de otros filtros de cajón, ambos en la cuba, estos sistemas nos permiten realizar un filtrado progresivo del agua del lavado quedando depositadas todas las partículas de diámetro superior a 1mm. Estos filtros de cajón son extraíbles.

En la aspiración de cada bomba hay otro filtro de seguridad para el agua.

Modelos TA31102 y TA31112 con módulo de prelavado de 820mm de longitud y cuba de 70L, sistema de lavado compuesto por 3 brazos y una bomba de lavado de doble flujo de 1500W.

Módulo de lavado de longitud 1150mm con una cuba de 70 l y sistema de lavado de 5 brazos con bomba de lavado de doble flujo.

Bomba de lavado con sistema DuoFlow, se elimina la división del flujo obteniendo menores pérdidas de carga y menor ruido.

Modelo TA31101 y TA31102 con dos programas de lavado, TA31111 y TA31112 con cuatro programas de lavado.

Sistema de aclarado con presión de red de agua entre 2 y 4.

Brazos de aclarado fabricados en composite, disponen en su interior unas canalizaciones que aseguran el flujo de agua con la menor carga posible. Boquillas fabricadas en acero.

Modelos TA31111 y TA31112 con sistema de aclarado ProRinse, que utiliza una bomba de aclarado de 200W que garantiza una presión y caudal constante del agua del aclarado sean cuales sean las condiciones de suministro de la red. Estos modelos concretos disponen del aclarado proporcional que permite variar la cantidad del agua del aclarado en función del programa de lavado permitiendo hasta un ahorro del consumo del agua del 25%.

**Modelo TA31111**  
**Lavado y aclarado con accesorios opcionales**

Model TA31111  
 Washing and rinsing with optional accessories

Modèle TA31111  
 lavage et rinçage avec accessoires en options

## BENEFITS

Structure made in double wall in stainless steel, this design allows us to reduce noise and loss of heat. Double wall doors with insulation. Useful loading height 450mm, allows us to wash larger objects.

Designed to facilitate cleaning, built-in wash tub without internal tubes with double and triple filter system of dirt from the water, with waste collection.

Exclusive sequential filtering on the TA31111 and TA31112 models, this is the combination of filters and other drawer filters, both in the tank, these systems allow us to perform a progressive filtering of the washing water, leaving all particles with a diameter greater than 1mm. These drawer filters are removable.

In the suction of each pump there is another filter of safety for the water.

Models TA31102 and TA31112 with prewash module of 820mm length and 70L tub, washing system composed of 3 arms and a dual flow washing pump of 1500W.

Wash module of length 1150mm with a tank of 70 l and system of washing of 5 arms with pump of washing of double flow.

Wash pump with DuoFlow system, eliminates the division of the flow obtaining smaller losses of load and less noise.

Model TA31101 and TA31102 with two washing programs, TA31111 and TA31112 with four washing programs.

Rinse system with water supply pressure between 2 and 4 bar.

Rinse arms made of composite, have pipes inside that ensure the flow of water with the lowest possible load. Nozzles made of steel.

Models TA31111 and TA31112 with ProRinse rinse system, which uses a 200W rinse pump to ensure a constant pressure and flow rate of the rinse water regardless of the supply conditions of the network. These specific models have a proportional rinse that allows the amount of rinse water to be varied depending on the washing program, allowing up to 25% water consumption savings.

## À SOULIGNER

Structure à double paroi en acier inoxydable, cette conception nous permet de réduire les pertes de bruit et de chaleur. Portes à double paroi avec isolation.

Hauteur utile 450 mm, nous permet de laver des objets plus gros.

Conçu pour faciliter le nettoyage, bac de lavage embouti sans tubes intérieurs avec système double et triple filtre de la saleté de l'eau, avec la collecte des déchets.

Filtrage séquentiel exclusif sur les modèles TA31111 et TA31112, il s'agit de la combinaison de filtres et d'autres filtres à tiroir, tous deux installés dans le réservoir. Ces systèmes nous permettent d'effectuer un filtrage progressif de l'eau de lavage en laissant toutes les particules présentes dans le réservoir (diamètre supérieur à 1mm). Ces filtres à tiroir sont amovibles.

Dans l'aspiration de chaque pompe, il y a un autre filtre de sécurité de l'eau.

Modèles TA31102 et TA31112 avec module de prélavage de 820mm de long et réservoir de 70L, système de lavage composé de 3 bras et d'une pompe de rinçage à double flux de 1500W.

Module de lavage de 1150 mm de long avec cuvette de 70 l et système de lavage à 5 bras avec pompe de lavage à double flux.

Pompe de lavage avec système DuoFlow, la division du flux est éliminée, ce qui permet d'atténuer les pertes de charge et le bruit.

Modèles TA31101 et TA31102 avec deux programmes de lavage, TA31111 et TA31112 avec quatre programmes de lavage.

Système d'allègement avec une pression du réseau d'eau comprise entre 2 et 4 bras d'allègement en composite, ils comportent des canaux intérieurs qui assurent le débit d'eau avec la charge la plus faible possible.

Buses en acier.

Les modèles TA31111 et TA31112 avec le système de rinçage ProRinse, qui utilise une pompe de rinçage 200 W, garantissent une pression et un débit constants de l'eau de rinçage quelles que soient les conditions d'alimentation du réseau. Ces modèles disposant d'un rinçage proportionnel qui permet de faire varier la quantité d'eau de rinçage en fonction du programme de lavage, permettant ainsi d'économiser jusqu'à 25% de la consommation d'eau.



## Serie / Series / Série TA

+Info: [www.infrico.com](http://www.infrico.com)

**Modelo TA31102/31112**  
**Prelavado, lavado y aclarado**  
**con accesorios opcionales.**

Model TA31102/31112  
 Pre-washing, washing and rinsing with  
 optional accessories.

Modèle TA31102/31112 Prélavage,  
 lavage et rinçage avec accessoires  
 en options.



MODELO/MODELE/MODÈLE	TA31101 Lavado y Aclarado Wash, Rinse Lavage, Rinçage	TA31102 Prelavado, Lavado, Aclarado Pre-wash, Wash, Rinse Prélavage, Lavage, Rinçage	TA31111 Lavado y Aclarado Wash, Rinse Lavage, Rinçage	TA31112 Prelavado, Lavado, Aclarado Pre-wash, Wash, Rinse Prélavage, Lavage, Rinçage	
<b>Precio</b> Price Prix					
<b>Medidas</b> Measures [mm] Mesures	1150x770x1615(2088)	1968x770x1615 (2088)	1150x770x1615 (2088)	1968x770x1615 (2088)	
<b>Medidas de cesta</b> Rack measures [mm] Mesures de panier	500x500				
<b>Altura útil de lavado</b> Washing height [mm] Hauteur utile de lavage	450				
<b>Productividad máxima</b> Max. productivity Productivité max. (cestas/h. racks/h. paniers/h)	<b>Máx. capacidad / Max. capacity / Max. capacité</b>	120	200	160	270
	<b>Baja velocidad / Low speed / Faible vitesse</b>	60	110	60	110
	<b>Tercera velocidad / 3rd speed / 3eme vitesse</b>	-	-	120	200
	<b>Vasos / glasses / verres</b>	-	-	80	135
<b>Tensión/Frecuencia</b> Electrical data [V/Hz] Tension électrique	400/50/3N				
<b>Potencia Total</b> Max. power [W] Puissance maximale	<b>Agua caliente / Hot water / Eau chaude 50°</b>	22000	29500	22000	29700
	<b>Agua fría / Cold water / Eau froide 10°</b>	28500	41000	31700	41200
	<b>Agua fría con recuperador de calor / Cold water with heat recovery / Eau glacée avec récupération de chaleur</b>	24700	34200	24900	34400
<b>Pot. resistencia cuba</b> Power tank resist. [W] Puiss. résist. cuvette	10500				
<b>Pot. resist. boiler</b> Boiler resist. power [W] Puiss. résist. boiler	9500/1600/12000	15500/27000/20000	9500/19000/12000	15500/27000/20000	
<b>Pot. bomba lavado /</b> Whashing / Pre-washing pump power / [W] Puissance bombe lavage / pré-lavage	1500 / -	1500 / 1500	1500 / -	1500 / 1500	
<b>Temp. Lavado/Aclar.</b> Wash/rinse temp. [°C] Temp. lavage/rinçage	<b>Máx. capacidad / Max. capacity / Max. capacité</b>	60°C/82°C		63°C/82°C	
	<b>Baja velocidad / Low speed / Faible vitesse</b>	60°C/82°C		63°C/82°C	
	<b>Tercera velocidad / 3rd speed / 3eme vitesse</b>	-		60°C/82°C	
	<b>Vasos / glasses / verres</b>	-		60°C/65°C	
<b>Consumo agua x cesta</b> Water/rack consumpt. [L] Consomat. eau x panier	160	270	140-200	240-320	
<b>Capacidad cuba/boiler</b> Tank/boiler capacity [L] Capacité cuvette	70/17				
<b>Dotación</b> Endowment Dotation	1 Cesto platos, 1 cesto plano, 1 contenedor cubiertos / 1 Plats rack, 1 flat rack, 1 storage cutlery / 1 panier assiettes, 1 range plat, 1 bac couverts				



## Accesorios lavavajillas de arrastre / Tunnels of wash accesories / Accessoires tunnels de lavage

Descripción Description Description	Medidas (mm) Measures (mm) Mesures (mm)	Imagen Image Image	Código Code Code	Precio Price Prix
<b>Prelavado en ángulo</b> Angle pre-wash Prélavage en angle <b>TA31102, TA31112 [P]</b>	990x820x1565		P	
<b>Modulo secado Túnel Arrastre</b> Drying module Tunnel conveyor Module séchage tunnel <b>TA [A]</b>	600x770x177,5		A	
<b>Modulo secado Túnel Arrastre</b> Drying module Tunnel conveyor Module séchage tunnel <b>TA [L]</b>	600x770x1775		L	
<b>Modulo secado en ángulo</b> Angle drying module Module séchage en angle <b>TA [B]</b>	820x879x1775		B	
<b>Modulo secado en ángulo</b> Angle drying module Module séchage en angle <b>TA [I]</b>	820x879x1775		I	
<b>Extractor vapor</b> Steam extractor Extracteur de vapeur <b>[E]</b>	<b>Diámetro 25- h 21</b> Diameter 25- h 21 Diamètre 25- h 21		E	
<b>Recuperador de calor condensador de vahos</b> Vapour condenser heat recovery unit Récupérateur de chaleur ou condensateur de buées <b>TA [R]</b>	<b>Diámetro 25- h 21</b> Diameter 25- h 21 Diamètre 25- h 21		R	
<b>Kit aumento resistencia calderín 9,5Kw [W]</b> Kit to increase boiler resistance 9,5Kw [W] Kit supplément résistance 9,5Kw [Réf. W]	-		W	
<b>Dosificador de detergente y abrillantador TA [Y]</b> Detergent and rinse aid dosing unit TA [Y] Doseur de détergent et brillant TA [Réf. Y]	-		Y	
<b>Interruptor Bloqueo emergencia [X]</b> Emergency lock switch [X] Interrupteur blocage urgence [Réf. X]	-		X	
<b>Reducción de presión con manómetro</b> Pressure reduction with gauge Réduction de pression avec manomètre <b>TA 31101, Ta31102 [N]</b>	-		N	
<b>Sonda nivel producto químico</b> Chemical level sensor Sonde niveau produit chimique	-		999257	
<b>Kit micro interruptor final de carrera</b> Limit switch micro kit Kit micro interrupteur fin de course	-		75861	

**Cuba embutida**  
Stamped pan  
Cuve emboutie



**Filtro**  
Filter  
Filtre



**Bomba lavado Duoflow**  
Washing pump Duoflow  
Pompe lavage Duoflow



**Otras medidas o modelos consultar  
disponibilidad y precio.**

For any other measurement or models,  
consult availability and price.

Autres dimensions et modèles,  
nous consulter.

## Accesorios lavavajillas de arrastre / Tunnels of wash accesories / Accessoires tunnels de lavage

+Info: [www.infrico.com](http://www.infrico.com)

Descripción Description Description	Medidas (mm) Measures (mm) Mesures (mm)	Imagen Image Image	Código Code Code	Precio Price Prix
<b>Mesa entrada/salida con entrepaño 700-1100mm</b> Entry/ out table 700-1100 mm Table entrée/sortie 700-1100 mm	700x700x850		75482	
	1100x700x850		75483	
<b>Mesa entrada/salida para secado 700-1100mm</b> Entry/out table for drying 700-1100mm Table entrée/sortie pour séchage 700-1100mm	700x700x850		75484	
	1100x700x850		75485	
<b>Mesa esquina para máquina con salida izquierda</b> Corner table for machine with left exit Table angle avec sortie à gauche	600x650x850		75480	
<b>Mesa esquina para máquina con salida derecha</b> Corner table for machine with right exit Table angle avec sortie à droite	600x650x850		75481	
<b>Mesa con fregadero (50x40cm)</b> <b>Máquina salida derecha 1200-1500-1800mm</b> Sink table (50x40cm) Machine right exit 1200-1500-1800mm Table avec évier (50x40cm) sortie à droite 1200-1500-1800mm	1200x700x850		75451	
	1500x700x850		75452	
	1800x700x850		75453	
<b>Mesa con fregadero (50x40cm)</b> <b>máquina salida izquierda 1200-1500-1800mm</b> Sink table (50x40cm) Machine left exit 1200-1500-1800mm Table avec évier (50x40cm) sortie à gauche 1200-1500-1800mm	1200x700x850		75456	
	1500x700x850		75457	
	1800x700x850		75458	
<b>Mesa prelavado con fregadero (50x40cm) y desbrasado para máquina salida derecha 1200-1500-1800mm</b> Sink prewash table (50x40cm) Machine right exit 1200-1500-1800mm Table pré-lavage avec évier (50x40cm) sortie à droite 1200-1500-1800mm	1200x700x850		75446	
	1500x700x850		75447	
	1800x700x850		75448	
<b>Mesa prelavado con fregadero (50x40cm) y desbrasado para máquina salida izquierda 1200-1500-1800mm</b> Sink prewash table (50x40cm) Machine left exit 1200-1500-1800mm Table pré-lavage avec évier (50x40cm) sortie à gauche 1200-1500-1800mm	1200x700x850		75441	
	1500x700x850		75442	
	1800x700x850		75443	
<b>Mesa rodillos con cuba y patas 1100-1600-2100-2600mm (Elemento de cierre +45mm)</b> Roller table with tank and legs 1100-1600-2100-2600mm (closing element +45mm) Table à rouleaux avec cuve et pieds 1100-1600-2100-2600mm (élément fermeture +45mm)	1145x630x875		717066	
	1645x630x875		717067	
	2145x630x875		717086	
	2645x630x875		717087	
<b>Mesa rodillos con cuba y patas sobre ruedas 1100-1600-2100mm (Elemento de cierre +45mm)</b> Roller table with bowl and legs on casters 1100-1600-2100mm (closing element +45mm) Table à rouleaux avec cuve et pieds sur roulettes 1100-1600-2100mm (élément fermeture +45mm)	1145x630x875		717069	
	1645x630x875		717070	
	2145x630x875		717088	
<b>Curva con rodillos 90°</b> Roller curve 90° Table courbe à rouleaux 90°	1100x1100x875		717068	



**Congelador tapa abatible /**  
Lid chest freezer /  
Congélateur avec couvercle battant

Serie / Series / Série **HF**



HF 500 AL HC

**Controlador digital**  
Adjustable thermostat  
Thermostat réglable



MODELO/MODELE/MODÈLE	HF 240 AL HC	HF 320 AL HC	HF 400 AL HC	HF 500 AL HC	HF 550 AL HC	HF 700 AL HC
<b>Precio</b> Price Prix						
<b>Medidas</b> Measures [mm] Mesures	830 660 860	990 660 860	1170 660 860	1400 660 860	1600 660 860	1570 751 1027
<b>Tensión/Frecuencia</b> Electrical data [V/Hz] Tension électrique	220V-240V/50Hz					
<b>Material</b> Material Matériel	Ext: Chapa galvanizada plastificada blanco / Galvanised steel white plastic coated / Tôle galvanisée plastifiée blanc. Int: Cuba interior en aluminio / Aluminium inner tank / Cuve intérieure en aluminium					
<b>Capacidad</b> Capacity [L] Capacité	176	220	285	344	439	664
<b>Nº Cesta [serie/opción]</b> Nº baskets [standard/optional] Nº Paniers [série/option]	2/0	2/1	2/2	2/3	2/4	2/4
<b>Compresor</b> Compressor Compresseur	1/9	1/9	1/7	1/6	1/3	1/3
<b>Temperatura</b> Temperature [32°C] Température	-17°C / -25°C					
<b>Condensación</b> Condensation Condenseur	Estática / Static / Statique					Ventilada / Ventilated / Ventilée
<b>Evaporación</b> Evaporation Évaporateur	Estática / Static / Statique					
<b>Desescarche</b> Defrost [Kg.] Dégivrage	Manual / Manual / Manuel					
<b>Capac. Congelación</b> Freezing capacity Puissance congélation	12	16	18	20	24	42
<b>Potencia</b> Power [W] Puissance	133	130	161	180	195	220
<b>Refrigerante</b> Refrigerant Gaz	HC R600a					R290
<b>Clase energética</b> Energy class Classe énergétique	F				-	
<b>Opcional</b> Optional Options	Cesta / Basket / Panier Cesta / Basket / Panier HF 700					



# Conservadora puerta corredera / Sliding doors conservator / Congélateur avec couvercle coulissant

Serie / Series / Série **HF**

HF 400 TCG

**Controlador digital**  
Adjustable thermostat  
Thermostat réglable



**Mod. TCC**  
**Tapa ciega**  
Solid lid  
Couvercle plein



**Mod. TCG**  
**Tapa cristal con llave**  
Glass lid with key  
Couvercle en verre avec clé

MODELO/MODELE/MODÈLE	HF 300 TCGHC HF 300 TCC HC	HF 400 TCGHC HF 400 TCC HC	HF 500 TCGHC HF 500 TCC HC
<b>Precio</b> Price Prix			
<b>Medidas</b>  Measures (mm) Mesures	1063 670 900	1283 670 900	1503 670 900
<b>Tensión/Frecuencia</b> Electrical data [V/Hz] Tension électrique	220V-240V/50Hz		
<b>Material</b> Material Matériel	Ext: Chapa galvanizada plastificada blanco / Galvanised steel white plastic coated / Tôle galvanisée plastifiée blanc. Int: Cuba interior en aluminio / Aluminium inner tank / Cuve intérieure en aluminium		
<b>Capacidad</b> Capacity [L] Capacité	256	327	398
<b>Nº Cesta [serie/opción]</b> Nº baskets [standard/optional] Nº Paniers [série/option]	Mod. TCG 2/2 Mod. TCC -	Mod. TCG 2/3 Mod. TCC -	Mod. TCG 2/4 Mod. TCC -
<b>Compresor</b> Compressor Compresseur	1/6	1/3	1/3
<b>Temperatura</b> Temperature [32°C] Température	<b>-18°C / -24°C</b>		
<b>Condensación</b> Condensation Condenseur	Ventilada / Ventilated / Ventilée		
<b>Evaporación</b> Evaporation Évaporateur	Estática / Static / Statique		
<b>Desescarche</b> Defrost [Kg.] Dégivrage	Manual/ Manual / Manuel		
<b>Capac. Congelación</b> Freezing capacity Puissance congélation	23	25	27
<b>Potencia</b> Power [W] Puissance	135	190	190
<b>Refrigerante</b> Refrigerant Gaz	<b>HC R600a</b>		
<b>Clase energética</b> Energy class Classe énergétique	<b>F</b>		
<b>Opcional</b> Optional Options	<b>Cesta / Basket / Panier TCG</b>		



## Congeladores tapa abatible -70°C / -60°C

Lid Chest freezers -70°C / -60°C

Congélateurs avec couvercle battant -70°C / -60°C

**IDEAL PARA ALMACENAR  
ATÚN PARA SUSHI**



**Controlador digital**  
Adjustable thermostat  
Thermostat réglable

**IDEAL FOR STORING  
TUNA FISH FOR SUSHI**



**IDÉAL POUR CONSERVER  
LE THON POUR LE SUSHI**



**Controlador digital**  
Adjustable thermostat  
Thermostat réglable

MODELO MODELE MODÈLE	<b>NEW</b> -70°C UL100	PRO 11	PRO 21	-60°C PRO 31	PRO 41	PRO 60
<b>Precio</b> Price Prix						
<b>Temperatura</b> Temperature Température (°C)	<b>-40°C/-70°C</b>	<b>-30°C/-60°C</b>				
<b>Medidas</b> Measures Mesures (EXT)	610 x 650 x 850 mm.	725 x 655 x 865 mm.	1055 x 655 x 865 mm.	1305 x 655 x 865 mm.	1505 x 655 x 865 mm.	1705 x 655 x 865 mm.
<b>Medidas</b> Measures Mesures (INT)	460 x 440 x 487 mm.	520 x 450 x 650 mm.	850 x 450 x 650 mm.	1100 x 450 x 650 mm.	1300 x 450 x 650 mm.	1540 x 450 x 650 mm.
<b>Tensión/Frecuencia</b> Electrical data Tension électrique	220-240V/50Hz	220V/50Hz				
<b>Controlador</b> Controller Régulateur	Danfoss Digital [Sin alarma/Without alarm/Sans alarme]	Dixell Digital con alarma acustica / Contacto libre para conectar a alarma externa / Dixell Digital with acoustic alarm / Free contact for connection to external alarm / Dixell Digital avec alarme sonore / Contact libre pour connexion à une alarme externe				
<b>Aislamiento</b> Isolation Isolation (mm)	70	102,5				
<b>Capacidad</b> Capacity Capacité [L NETOS]	99	130	226	300	360	481
<b>Nº Cesta [serie/opción]</b> Nº baskets [standard/optional] Nº Paniers [série/option]	1/0	0/2	0/3	0/4	0/5	-
<b>Condensación</b> Condensing Condensation	Condensador interior en parte trasera, condensador estatico en la trasera y ventilador de apoyo al compresor / Inner rear condenser, rear static condenser and compressor support fan / Condenseur intérieur à l'arrière, condenseur statique à l'arrière et ventilateur de support du compresseur.					
<b>Evaporador</b> Cooler Évaporateur	Estático (tubo de aluminio) / Static (aluminium tube) / Statique (tube d'aluminium)					
<b>Desescarche</b> Defrost Dégivrage	Manual / Manual / Manuel					
<b>Potencia</b> Power Puissance [W]	480	375	455	544	587	612
<b>Consumo</b> Consumption Consommation [kWh/ 24h]	6	4,3	5	5,2	6,1	9,2
<b>Refrigerante</b> Refrigerant Gaz	<b>R290 + R170</b>	<b>R600a + R1150</b>				
<b>Opcional</b> Optional Options	-					

Serie / Series / Série **PRO**

**NEW**



UL100

**NEW**



UL100



PRO 11



PRO 21



PRO 31



PRO 41



PRO 60



# Conservadora expositora puerta cristal / Horizontal freezer with glass LID / Conservateur panoramique congélation

Serie / Series / Série **IL**

**Aislamiento (100% libre de CFC'S), con 60 mm de espesor >=42,5Kg/m<sup>3</sup>.**  
**Evaporador y condensador en tubería de cobre.**  
**Condensador libre mantenimiento.**  
**Controlador digital.**  
**Tapas correderas de cristal, marco calentado para evitar bloqueo de tapas.**

Injected insulation (100% CFC'S free) with 60 mm thickness >=42,5Kg/m<sup>3</sup>.  
Evaporator and condensator in copper.  
Free maintenance condenser. Digital controller.  
Sliding glass lid, heated frame to avoid blocking of lids

Isolation (100% sans CFC 'S), 60 mm d'épaisseur >=42,5Kg/m<sup>3</sup>.  
Évaporateur et condensateur avec tuyauterie en cuivre.  
Thermostat réglable.  
Thermomètre analogique.  
Dessus portes coulissantes vitrées, encadrement chauffé pour éviter le blocage des portes vitrées.

Serie / Series / Série **CHE**

**Aislamiento (100% libre de CFC'S), con 70 mm de espesor >=42,5Kg/m<sup>3</sup>.**  
**Evaporador y condensador en tubería de cobre.**  
**Condensador de libre mantenimiento. Controlador digital.**  
**Tapas correderas de cristal (Mod. TC) o tapa abatible (Mod. TA), con marco calentado para evitar el bloqueo de tapas.**  
**Iluminación interior.**

Injected insulation (100% CFC'S free) with 70 mm thickness >=42,5Kg/m<sup>3</sup>.  
Evaporator and condensator in copper.  
Free maintenance condenser. Digital controller.  
Sliding glass lid (TC) or lift lid (TA), heated frame to avoid blocking of lids.  
Internal illumination.

Isolation (100% sans CFC'S), 70 mm d'épaisseur >=42,5Kg/m<sup>3</sup>.  
Évaporateur et condensateur avec tuyauterie en cuivre.  
Condenseur en libre maintenance. Contrôleur digital.  
Dessus portes coulissantes (Mod. TC) ou couvercle battant (Mod. TA), avec encadrement chauffé pour éviter le blocage des portes vitrées.  
Éclairage intérieur.

MODELO/MODELE/MODÈLE	IL 1500 HC	IL 2000 HC	IL 2500 HC	CHE 1500 TC HC	CHE 2000 TC HC	CHE 1770 TC HC
<b>Precio</b> Price Prix						
<b>Medidas</b> Measures (mm) Mesures	1550 960 780	2050 960 780	2500 960 780	1500 880 940	2000 880 940	1770 840 900
<b>Tensión/Frecuencia</b> Electrical data [V/Hz] Tension électrique	220V-240V/50Hz					
<b>Material</b> Material Matériel	Exterior e interior en chapa galvanizada revestida en PVC blanco. Exterior and interior of galvanized steel, white plastic coated. Extérieur et intérieur en tôle galvanisée en PVC blanc.					
<b>Capacidad</b> Capacity (L) Capacité	459	652	805	350	518	370
<b>N° Cesta (serie/opción)</b> N° baskets (standard/optional) N° Paniers [série/option]	[1/3]=4	[1/5]=6	[1/7]=8	0/5	0/6	n/d
<b>Divisoria Alta-Baja</b> Divider High-Low Diviseur Haut-Bas	-			1/1	1/1	1/1
<b>Compresor</b> Compressor Compresseur	2 [1/5]	2 [1/5]	2 [1/5]	2 [1/5]	2 [1/5]	2 [1/5]
<b>Temperatura</b> Temperature (3L1) Température	-18°C / -22°C			-18°C / -22°C		
<b>Condensación</b> Condensation Condenseur	Ventilada / Ventilated / Ventilée					
<b>Evaporación</b> Evaporation Évaporateur	Estática / Static / Statique					
<b>Desescarche</b> Defrost (Kg.) Dégivrage	Manual/ Manual / Manuel					Semiautomático / Semi-automatic / Semi-automatique
<b>Consumo</b> Consumption (Kwh/24h) Consommation	3,9	4,5	4,9	7,5	8,4	9
<b>Potencia</b> Power (W) Puissance	305	345	345	526	526	549
<b>Refrigerante</b> Refrigerant Gaz	<b>R290</b>					
<b>Clase energética</b> Energy class Classe énergétique	<b>C</b>	<b>B</b>	<b>C</b>	<b>E</b>	<b>D</b>	<b>E</b>
<b>Opcional</b> Optional Options	Porta precios/Carries prices/Porte prix			Porta precios/Carries prices/Porte prix		
	Barra divisoria/Divider bar/Barre de div. grille séparation			Kit unión / Union kit / Kit union		
	Cesta/Basket/Panier Cesta pequeña/Small Basket/Petit panier Cubeta plástico/Plastic Basket/Cuve plastique Divisoria alta/High Divider/Grille sépar. haute Divisoria baja/Small divider/Grille sépar. basse			Cesta / Basket / Panier		
	Antracita exterior, consultar Ext. Anthracite, to consult Anthracite extérieur, consulter					

Serie / Series / Série **IL**  
 Serie / Series / Série **CHE**

+Info: [www.infrico.com](http://www.infrico.com)



IL2000HC









CHE2000TCHC[4] + CHE1770TCHC

**CHE 1770 TC HC**

TC: Tapa corredera  
 TC: Sliding lid  
 TC: Couvercle coulissant



**Conservadora expositora puerta cristal curvada /**  
**Conservative of curved glass crystal door /**  
**Conservateur panoramique pour surgelés**

MODELO MODELE MODÈLE							
	EHC1500 DEHC	EHC2000 DEHC	EHC2200 DEHC	EHC2500 DEHC	EHC1970 DETHC	EHCD2150 DEHC	EHCD1470 DEHC
Precio Price Prix							
Temperatura Temperature Température	-16°C/-24°C						

MOD.	EHC1500 DEHC	EHC2000 DEHC	EHC2200 DEHC	EHC2500 DEHC	EHC1970 DET HC		
Precio Price Prix	MIXTO MIXTE MIXTE						
Temperatura Temperature Température	-16°C/-24°C +10°C/-24°C						
Medidas Measures Mesures	1520 x 920 x 790 mm.	2020 x 920 x 790 mm.	2200 x 920 x 790 mm.	2500 x 920 x 790 mm.	1990 x 920 x 790 mm.	2150 x 1465 x 930 mm.	1470 x 811 x 902 mm.
Clase Climática Climatic class Classe climatique	3 L1 [25°C/60% Hr] 3 M1 [25°C/60% Hr]						
Tensión/Frecuencia Electrical data Tension électrique	230V/1ph/50Hz						
Controlador Controller Régulateur	Digital						
Material Material Matériel	Chapa de acero galvanizado, recubierta de PVC / Galvanized sheet steel, PVC coated / Tôle d'acier galvanisée, revêtement en PVC						
Aislamiento Isolation Isolation	70mm [42,5kg/m³] / Free CFC's / Zero ODP-GWP						
Capacidad Capacity Capacité	400	580	630	750	430	1255	334
Compresor Compressor Compresseur	2 [1/5] 2 [1/3+]	2 [1/5] 2 [1/3+]	2 [1/5] 2 [1/3+]	2 [1/5] 2 [1/3+]	2 [1/5] 2 [1/5]	2 [1/3]	2 [1/5]
Nº Cesta (serie/opción) Nº baskets (standard/optional) Nº Paniers [série/option]	0/3	0/5	0/6	0/7	-	-	-
Divisoria (serie/opción) Divider (standard/optional) Diviseur [série/option]	1/7	2/7	2/7	2/7	2/7	4/6	2/3
Condensación Condensing Condensation	Ventilado / Ventilated / Ventilé						
Desescarche Defrost Dégivrage	Automático / Automatic / Automatique						
Evaporación Evaporation Évaporation	Estática / Static / Estatique						
Potencia Power Puissance	598 759	662 777	662 777	681 796	656 771	672	413
Potencia frig. Cooling capacity Puissance Frig.	-						
Consumo Consumption Consommation	6,10 7,30	6,40 7,50	7,00 7,80	7,80 8,30	6,70 8,80	9,2	4,10
Clasif. energética Energy classifc. Classif. énergétique	<b>D</b> <b>D</b>	<b>C</b> <b>D</b>	<b>C</b> <b>D</b>	<b>C</b> <b>D</b>	<b>C</b> <b>D</b>	<b>C</b>	
Refrigerante Refrigerant Gaz	<b>R-290</b>						
Opcional Optional Options	Cesta / Basket / Panier					Porta precios / Ticket strip / Porte prix	
	Parrilla divisoria / Divider wire / Grille de séparation						
	Kit unión / Assembly kit / Kit union						
	Porta precios / Ticket strip / Porte prix						
	Rodapie / Skirting board / Plinthe						
	Consultar / To consult / Consulter						

Serie / Series / Série **EHC / EHC D**  
 Serie / Series / Série **EHC R**



**Lineal EHC1970 DETHC + EHC2000 DEHC**  
 EHC1970 DETHC + EHC2000 DEHC Linear assembly  
 Assemblage lineaire EHC1970 DETHC + EHC2000 DEHC

**Decor. Exterior**  
**Decor. Exterior**  
**Décor. Ext.**

<b>Ral 9016</b> <b>Blanco</b> White Blanc	<b>Negro exterior,</b> consultar Ext. black, to consult Noir extérieur, consulter	<b>Antracita exterior,</b> consultar Ext. Anthracite, to consult Anthracite extérieur, consulter
--	--	---

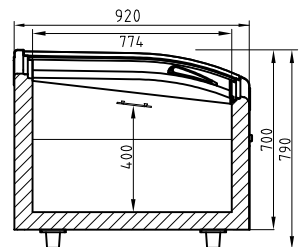

**EHC2500 DEHC**



**EHC1470 DEHC**

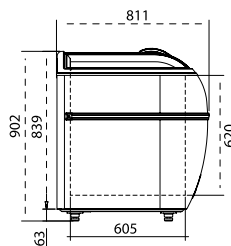
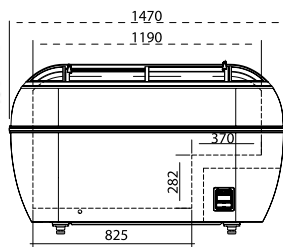

**Decor. Exterior**  
**Decor. Exterior**  
**Décor. Ext.**

<b>Ral 9016</b> <b>Blanco</b> White Blanc	<b>Negro exterior,</b> consultar Ext. black, to consult Noir extérieur, consulter	<b>Antracita exterior,</b> consultar Ext. Anthracite, to consult Anthracite extérieur, consulter
--	--	---



**Lineal EHCD2150 DEHC**  
 EHCD2150 DEHC Linear assembly  
 Assemblage lineaire EHCD2150 DEHC

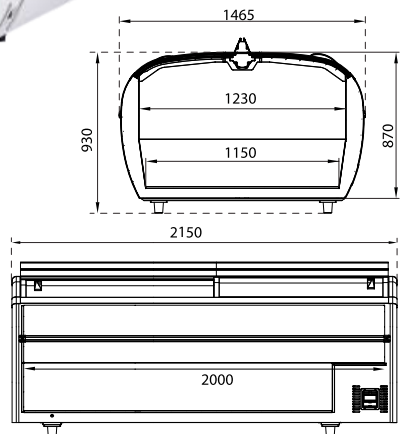

**Expositora conservadora horizontal VISION, compresor VSC /**  
**Horizontal conservative display VISION, VSC compressor /**  
**Conservateur panoramique Vision, compresseur VSC**

MODELO  
 MODELE  
 MODÈLE



EHCV 2000 VSC



EHCV 2500 VSC



EHCV 2000 TVSC

MODELO MODELE MODÈLE	EHCV 2000 VSC	EHCV 2500 VSC	EHCV 2000 TVSC
Precio Price Prix			
Temperatura Temperature Température	+10°C/-22°C		
Medidas Measures Mesures	1953 x 980 x 970 mm.	2500 x 980 x 970 mm.	1983 x 980 x 970 mm.
Clase Climática Climatic class Classe climatique	3 L1 [25°C/60% Hr] 3 M1 [25°C/60% Hr]		
Tensión/Frecuencia Electrical data Tension électrique	220-240V/50-60Hz		
Controlador Controller Régulateur	Dixell Digital		
Material Material Matériel	Chapa de acero galvanizado, recubierta de PVC / Galvanized sheet steel, PVC coated / Tôle d'acier galvanisée, revêtement en PVC		
Aislamiento Isolation Isolation	70mm [42,5kg/m³]		
Capacidad Capacity Capacité	613	821	613
Compresor Compressor Compresseur	1 1/4HP VSC regulación capacidad inverter / 1 1/4HP VSC inverter capacity control / 1 1/4HP VSC contrôle de la capacité inverter		
Nº Puertas Doors Portes	2	2	2
Divisoria (serie/opción) Divider (standard/optional) Diviseur (série/option)	2/7	2/7	2/7
Condensación Condensing Condensation	Ventilado / Ventilated / Ventilé		
Desescarche Defrost Dégivrage	Automático / Automatic / Automatique		
Evaporación Evaporation Évaporation	Estática / Static / Estatique		
Potencia Power Puissance	1300	1300	1300
Potencia frig. Cooling capacity Puissance Frig.	1000	1000	1000
Consumo Consumption Consommation	10,6	11,8	10,6
Clasif. energética Energy classifc. Classif. énergétique	D	D	D
Refrigerante Refrigerant Gaz	R-288		
Opcional Optional Options	Parrilla divisoria / Divider wire / Grille de séparation		
	Porta precios / Ticket strip / Porte prix		



**NEW**

Serie / Series / Série **EHC VISION VSC**

EHCV2000VSC

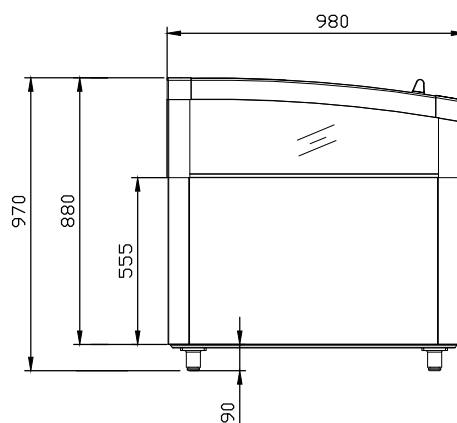

EHCV VSC/TVSC

EHCV2500VSC



**Decor. Exterior /  
Exterior Decor./  
Décoration Ext.**

**Ral 9016**  
Blanco  
White  
Blanc

**Negro,**  
consultar  
Black,  
to consult  
Noir,  
consulter

**Antracita,**  
consultar  
Anthracite,  
to consult  
Anthracite,  
consulter

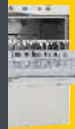

# Armario de refrigeración y congelación / Chillers and freezers / Congélateur vertical

## A DESTACAR

Modelos con puerta ciega SD con tirador integrado en la puerta (RV200ISD y FS200ISD) y modelos con puerta de cristal GD con tirador en acero inoxidable (RV200IGD y FS200IGD).

Puerta de cristal con doble cristal en los modelos de refrigeración, triple cristal templado y calefactado en los modelos de baja temperatura.

Modelos de refrigeración RV con dos estantes regulables y modelos de congelación FS dos estantes no regulables.

Termostato digital.

Cerradura con llave de serie.

Iluminación Led en el modelo de refrigeración con puerta de cristal.

Reguladores en la parte frontal y rodillo en la parte trasera para facilitar el desplazamiento.

## BENEFITS

Models with blind door SD with integrated door handle (RV200ISD and FS200ISD) and models with glass door GD with handle in stainless steel (RV200IGD and FS200IGD).

Glass door with double glazing in the cooling models, triple tempered glass and heated in the low temperature models.

RV refrigeration models with two adjustable shelves and FS freezing models, two non-adjustable shelves.

Digital thermostat.

Lock with serial key.

LED lighting in the cooling model with glass door.

Regulators on the front and roller on the back for easy movement.

## À SOULIGNER

Modèles avec porte pleine SD avec poignée intégrée dans la porte (RV200ISD et FS200ISD) et modèles avec porte vitrée GD avec poignée en acier inoxydable (RV200IGD et FS200IGD).

Porte avec double vitrage dans les modèles de réfrigération, triple vitrage avec verre trempé et chauffée dans les modèles à basse température.

Modèles de réfrigération RV avec deux niveaux réglables et modèles de congélation FS, deux niveaux non réglables.

Thermostat numérique.

Serrure avec clé de série.

Éclairage Led pour les modèles de réfrigération avec porte vitrée.

Régulateurs frontal et petits rouleaux à l'arrière pour faciliter le déplacement.

MODELO/MODELE/MODELE	RV 200 ISD	RV 200 IGD	FS 200 ISD	FS 200 IGD
<b>Precio</b> Price Prix				
<b>Medidas</b> Measures [mm] Mesures	600 620 835	600 620 835	600 620 835	600 620 835
<b>Tensión/Frecuencia</b> Electrical data [V/Hz] Tension électrique	230V / 50Hz			
<b>Material</b> Material Matériel	Exterior en acero inoxidable e interior en termoconformado ABS. Exterior in stainless steel and interior in ABS thermoformed. Extérieur en acier inoxydable et intérieur en thermoformage ABS.			
<b>Capacidad</b> Capacity Capacité [L]	150	150	150	150
<b>Estantes</b> Shelves Étagères	2 regulables en altura 2 height adjustable 2 réglables en hauteur	2 regulables en altura 2 height adjustable 2 réglables en hauteur	2 fijas 2 fijas 2 fijas	2 fijas 2 fijas 2 fijas
<b>Medidas estantes</b> Shelves dimens. [mm] Mesures étagères	410x500		450x500	
<b>Puerta</b> Door Porte	Ciega / Solid	Cristal / Glass	Ciega / Solid	Cristal / Glass
<b>Temperatura</b> Temperature [32°C] Température	0°C / +8°C	+2°C / +8°C	-18°C / -21°C	-18°C / -21°C
<b>Condensación</b> Condensation Condenseur	Estática / Static / Statique			Estática con ventilador Static with cooler Statique avec ventilateur
<b>Evaporación</b> Evaporation Évaporateur	Ventilado / Ventilated / Ventilé Roll-bond		Estática / Static / Statique	
<b>Desescarche</b> Defrost Dégivrage [Kg.]	Automático / Automatic / Automatique		Manual/ Manual / Manuel	
<b>Consumo</b> Consumption [Kwh/24h] Consommation	1,7	3,2	1,66	2,8
<b>Potencia</b> Power Puissance [W]	140	140	80	150
<b>Refrigerante</b> Refrigerant Gaz	HC R600a			R290
<b>Opcional</b> Optional Options	-			

Serie / Series / Série **MINI ARMARIO**

+Info: [www.infrico.com](http://www.infrico.com)



RV200ISD



RV200IGD



FS200ISD



FS200IGD

**Cerradura**  
Door lock  
Serrure



**Interruptor**  
Switch  
Interrupteur



**Control digital**  
Digital control  
Contrôle digital



# Armario de refrigeración y congelación 400L / 400L Chillers and freezers / Congélateur vertical 400L

## A DESTACAR

Modelos con puerta ciega SD con tirador integrado en la puerta (RV400ISD y FS400ISD) y modelos con puerta de cristal GD con tirador en acero inoxidable (RV400IGD y FS400IGD).

Puerta de cristal con doble cristal en los modelos de refrigeración, triple cristal templado y calefactado en los modelos de baja temperatura.

Termostato digital.

Cerradura con llave de serie.

Iluminación Led en modelos con puerta de cristal.

## BENEFITS

Models with blind door SD with integrated door handle (RV400ISD and FS400ISD) and models with glass door GD with handle in stainless steel (RV400IGD and FS400IGD).

Glass door with double glazing in the cooling models, triple tempered glass and heated in the low temperature models.

Digital thermostat.

Lock with serial key.

LED lighting in the models with glass door.

## À SOULIGNER

Modèles avec porte pleine SD avec poignée intégrée dans la porte (RV400ISD et FS400ISD) et modèles avec porte vitrée GD avec poignée en acier inoxydable (RV400IGD et FS400IGD).

Porte avec double vitrage dans les modèles de réfrigération, triple vitrage avec verre trempé et chauffée dans les modèles à basse température.

Thermostat numérique.

Serrure avec clé de série.

Éclairage Led pour les modèles avec porte vitrée.



MODELO/MODELE/MODÈLE

RV 400 SD

RV 400 GD

FS 400 SD

FS 400 GD

Modelo/Modele/Modèle	RV 400 SD	RV 400 GD	FS 400 SD	FS 400 GD
<b>Precio</b> Price Prix				
<b>Medidas</b> Measures Mesures	<b>INT</b> ↔ ↕ [mm] 600 685 1890	600 723 1890	600 685 1890	600 723 1890
<b>Medidas</b> Measures Mesures	<b>EXT</b> ↔ ↕ [mm] 480 540 1680	480 540 1680	470 533 1665	470 533 1665
<b>Temperatura</b> Temperature Température	2°C / +10°C	M1: -1°C / +5°C	-18°C / -22°C	L1: -15°C / -18°C
<b>Tensión/Frecuencia</b> Electrical data Tension électrique	230V / 50Hz			
<b>Material</b> Material Matériel	Exterior en acero gris, puerta ciega Inox, puerta cristal con marco de aluminio, interior en termoconformado ABS. Exterior in steel grey, solid door Stainless steel, glass door aluminium frame, interior in ABS thermoformed. Extérieur en acier gris, porte aveugle en Inox, porte vitrée avec cadre en aluminium, intérieur thermoformé en ABS.			
<b>Capacidad</b> Capacity Capacité	400			
<b>Controlador</b> Controller Régulateur	Digital			
<b>Iluminación</b> Lighting Éclairage	No	LED horizontal parte superior / Top horizontal LED / Top horizontal LED	No	LED Vertical / Vertical LED / Led Verticale
<b>Estantes</b> Shelves Étagères	4 Regulables/Adjustable/Réglable + 1 base		6	
<b>Medidas estantes</b> Shelves dimens. Mesures étagères	6 [476x481x40] + 1 [476x292x40]		Nivel del evaporador / Evaporator layer / Niveau de l'évaporateur 414x410	
<b>Puerta</b> Door Porte	Ciega / Solid	Cristal / Glass	Ciega / Solid	Cristal / Glass
<b>Condensación</b> Condensation Condenseur	Estática / Static / Statique			
<b>Evaporación</b> Evaporation Évaporateur	Ventilado / Ventilated / Ventilé Roll-bond		Estática / Static / Statique	
<b>Desescarche</b> Defrost Dégivrage	Automático / Automatic / Automatique		Manual/ Manual / Manuel	
<b>Consumo</b> Consumption Consommation	1,71	1,96	1,98	4,77
<b>Potencia</b> Power Puissance	200	200	400	450
<b>Refrigerante</b> Refrigerant Gaz	HC R600a		R290	
<b>Opcional</b> Optional Options	-		Cestas / Baskets / Paniers 60mm (7Uds)	

**NEW**

Serie / Series / Série **400L**

+Info: [www.infrico.com](http://www.infrico.com)

RV400SD



RV400GD



**Cerradura**  
Door lock  
Serrure



**Control digital**  
Digital control  
Contrôle digital



FS400SD



FS400GD



# Congelador vertical / Freezer / Congélateur vertical

## A DESTACAR

Aislamiento en poliuretano inyectado a alta presión [100% libre de CFC'S], con 55 mm de espesor.

Los modelos CV 130HC de serie con parrillas, el resto de modelos de serie con cajones extraíbles.

Panel de mandos [Termostato HC, piloto red, piloto alarma e interruptor congelación rápida].

## BENEFITS

Injected polyurethane isolation to high pressure [100% free one of CFC'S], with 55 mm thickness.

Models CV 130 HC of the series with grills, the rest of models of series with removable drawers.

Control panel [Thermostat, pilot network, pilot alarm and fast freeze switch].

## À SOULIGNER

Isolation en polyuréthane injecté à haute pression [100% sans CFC'S], avec 55 mm d'épaisseur.

Les modèles CV 130 HC sont de série avec grilles, les autres modèles sont avec tiroirs amovibles de série.

Panneau de commande [Thermostat, réseau pilote, alarme pilote et interrupteur congélation rapide].

Dans des modèles CV 220 et CV 330 ouverture de porte 135° pour extraction tiroirs.

MODELO/MODELE/MODÈLE	CV 130 HC CV 130 I HC	CV 220 HC	CV 330 HC
<b>Precio</b> Price Prix			
<b>Medidas</b> Measures [mm] Mesures	540 600 870	540 600 1340	540 600 1920
<b>Tensión/Frecuencia</b> Electrical data [V/Hz] Tension électrique	220-240/50		
<b>Material</b> Material Matériel	Exterior chapa plastif. blanca [CV130IHC en chapa inox]. Interior termoconformado Exterior white plastic-coated sheet [CV130IHC in stainless steel inox]. Thermoformed interior Extérieur plastifié blanc [CV130IHC en tôle inox.] Intérieur thermoformé		
<b>Capacidad</b> Capacity Capacité	112	157	233
<b>Estantes</b> Shelves Étagères	3+1	7	9 [2 abatibles]
<b>Temperatura</b> Temperature [32°C] Température	-18°C / -23°C		
<b>Condensación</b> Condensation Condenseur	Estática / Static / Statique		
<b>Evaporación</b> Evaporation Évaporateur	Estática / Static / Statique		
<b>Desescarche</b> Defrost [Kg.] Dégivrage	Manual/ Manual / Manuel		
<b>Compresor</b> Compressor Compresseur	1/9	1/6	1/9+1/8
<b>Potencia</b> Power [W] Puissance	80	110	80+100
<b>Capacid. congelación</b> Freezing capacity [Kg/24h] Pouvoir congélation	7	12	24
<b>Refrigerante</b> Refrigerant Gaz	HC R600a		
<b>Opcional</b> Optional Options	CV130 I HC 4 cajones / 4 drawers / 4 tiroirs:	Apertura puerta 135° para extracción de cajones. Door opening 135° for extraction of drawers. Ouverture de porte 135° pour extraction de tiroirs.	Chapa color inox. Plate color inox Tôle couleur inox.  Apertura puerta 135° para extracción de cajones. Door opening 135° for extraction of drawers. Ouverture de porte 135° pour extraction de tiroirs.

Serie / Series / Série **CV**

+Info: [www.infrico.com](http://www.infrico.com)



CV 130 INOX HC

**Parrillas**  
Grills  
Grilles



**Cajones en opción**  
Drawers optional  
Tiroirs en option

**Puertas abatibles**  
Tilt forward doors  
Portes battantes



CV 330 HC

**[9 cajones]**  
[9 drawers]  
[9 tiroirs]



CV 220 HC

**[7 cajones]**  
[7 drawers]  
[7 tiroirs]



# Armario expositor heladería y pastelería / Exhibiting cupboard for ice-cream and pastry / Armoire d'exposition pour la glace et la pâtisserie

## A DESTACAR

Exposición de 1 a 4 caras en cristal.  
Estantes interiores en cristal de 530x450 mm [Mod. L03505, L03702, L07700].  
Evaporador estático de 5 niveles en armarios heladería [L03500/3700/7703].  
Estantes giratorios de diámetro 460 mm [Mod. L03701].  
Ruedas en todos los modelos.  
Iluminación interior LED.

## BENEFITS

Four face glass exhibition.  
Interior shelves in glass of 530x450 [Mod. L03505, L03702, L07700].  
5-level static evaporator in ice cream cabinets [L03500/3700/7703].  
Rotating shelved with a 460 diameter [Mod. L03701].  
Castors in all of the models.  
LED lighting.

## À SOULIGNER

Quatre faces vitrées.  
Étagères intérieures vitrées, 530x450mm [Mod. L03505, L03702, L07700].  
Évaporateur statique à 5 niveaux dans les armoires à glace [L03500/3700/7703].  
Étagères tournantes 460mm [Mod. L03701].  
Roulettes sur tous les modèles.  
Éclairage intérieur LED.

### HELADERÍA / ICE-CREAM / GLACE



L03500



L03700

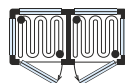

L07703



L03505



L03702



L03701

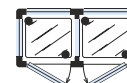

L07700

MODELO/MODELE/MODÈLE	L03500	L03700	L07703	L03505	L03702	L03701	L07700
<b>Precio</b> Price Prix							
<b>Medidas</b> Measures (mm) Mesures	700 650 1900	700 650 1900	1320 650 1900	700 650 1900	700 650 1900	700 650 1900	1320 650 1900
<b>Tensión/Frecuencia</b> Electrical data [V/Hz] Tension électrique	220/50						
<b>Material</b> Material Matériel	Estructura en aluminio anodizado con decoración de serie en Plata. Anodised aluminium structure with round forms, and with silver series decorations. Structure en aluminium anodisé avec décoration en argent de série.						
<b>Capacidad</b> Capacity Capacité	420	420	420+420	420	420	420	420+420
<b>Caras de cristal</b> Glass sides Faces vitrées	1	4	4	1	4	4	4
<b>Puertas</b> Doors Portes	1	1	2	1	1	1	2
<b>Estantes</b> Shelves Étagères	5 fijos + 1 móvil 5 fixed + 1 mobile 5 fixes + 1 amovible		5+5 fijos + 1+1 móvil 5+5 fixed + 1+1 mobile 5+5 fixes + 1+1 amovible	5 móvil 5 mobile 5 amovible	5 móvil 5 mobile 5 amovible	6 giratorios 6 rotating 6 tournantes	5+5 móvil 5+5 mobile 5+5 amovible
<b>Temperatura</b> Temperature (30°C) Température	-15°C / -24°C			+2°C / +10°C (40%-60% HR)			
<b>Condensación</b> Condensation Condenseur	Ventilada / Ventilated / Ventilée						
<b>Evaporación</b> Evaporation Évaporateur	Estática / Static / Statique						
<b>Desescarche</b> Defrost Dégivrage (Kg.)	Manual/ Manual / Manuel			Automático / Automatic / Automatique			
<b>Compresor</b> Compressor Compresseur (HP)	1/2	1/2	1/2 + 1/2	1/4	1/4	1/4	1/4 + 1/4
<b>Potencia</b> Power Puissance (W)	471	511	942	365	365	395	730
<b>Refrigerante</b> Refrigerant Gaz	R290						
<b>Opcional</b> Optional Options	Acabado blanco o negro / White or black finish / Finition noir ou blanc  Largo / wide / Longueur 700: Largo / wide / Longueur 1320:						



Serie / Series / Série **LO**

+Info: [www.infrico.com](http://www.infrico.com)

**HELADERÍA / ICE-CREAM / GLACE**



L03500



L03700

**PASTELERÍA / PASTRY / PÂTISSERIE**



L03702



L07700



# Armario expositor SOFT AIR pastelería [opcional chocolate y bombones] / Exhibiting cupboard pastry SOFT AIR [chocolates optional] / Armoire d'exposition pâtisserie SOFT AIR [en option pour le chocolat et les bonbons]

Línea de vitrinas con refrigeración ventilada, con régimen de temperatura -2°C a +15°C.  
5 Parrillas por puerta regulables en altura de medida 530x450mm, o estantes de cristal sin incremento de precio.  
Estantes interiores en rejilla cromada de 530x450mm. [mod. L03905, L03902, L07900].  
Estantes giratorios de 460mm de diámetro [Lo3901].  
Iluminación interior LED.  
Ruedas en todos los modelos.

Line of showcases with ventilated cooling, with temperature range -2°C to +15°C.  
5 Shelves adjustable in height of measurement 530x450mm, or glass shelves without supplement.  
Interior shelves in chrome grille 530x450mm. [mod. L03905, L03902, L07900].  
Rotating shelves 460mm diameter [Lo3901].  
Interior LED lightning.  
Wheels on all models.

Ligne de vitrines à refroidissement ventilée, avec régime de température -2°C à +15°C.  
5 Étagères réglables en hauteur, 530x450mm, ou étagères en verre sans frais supplémentaires.  
Étagères intérieures en grille chromée 530x450mm. [mod. L03905, L03902, L07900].  
Étagères rotatives de 460 mm de diamètre [Lo3901].  
Éclairage LED intérieur.  
Roulettes sur tous les modèles.



L03905

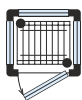

L03902



L03901

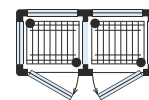

L07900

MODELO/MODELE/MODÈLE	L03905	L03902	L03901	L07900
<b>Precio</b> Price Prix				
<b>Medidas</b> Measures (mm) Mesures	700 650 1900	700 650 1900	700 650 1900	1320 650 1900
<b>Tensión/Frecuencia</b> Electrical data [V/Hz] Tension électrique	220/50			
<b>Material</b> Material Matériel	Estructura en aluminio anodizado con decoración de serie en Plata. Anodised aluminium structure with round forms, and with silver series decorations. Structure en aluminium anodisé avec décoration en argent de série.			
<b>Capacidad</b> Capacity Capacité	420	420	420	420+420
<b>Caras de cristal</b> Glass sides Faces vitrées	1	4	4	4
<b>Puertas</b> Doors Portes	1	1	1	2
<b>Estantes</b> Shelves Étagères	5	5	6 giratorios 6 rotating 6 tournantes	5+5
<b>Temperatura</b> Temperature (30°C) Température	-2°C / +15°C			
<b>Condensación</b> Condensation Condenseur	Ventilada / Ventilated / Ventilée			
<b>Evaporación</b> Evaporation Évaporateur	Ventilada / Ventilated / Ventilée			
<b>Desescarche</b> Defrost (Kg.) Dégivrage	Automático / Automatic / Automatique			
<b>Compresor</b> Compressor (HP) Compresseur	1/2	1/2	1/2	1/2 + 1/2
<b>Potencia</b> Power (W) Puissance	1014	1044	1074	1044+1044
<b>Refrigerante</b> Refrigerant Gaz	R290			
<b>Opcional</b> Optional Options	Opción chocolate y bombones / Chocolate option / Chocolate et bonbons en option Temp: +15°C / +18°C [40% / 60% HR]			
	Opción quesos / Cheese option / Option fromages			
	Acabado blanco o negro / White or black finish / Finition noir ou blanc <div style="display: flex; align-items: center; gap: 10px;"> <div style="width: 20px; height: 20px; background-color: black; border: 1px solid black;"></div> <div style="width: 20px; height: 20px; background-color: white; border: 1px solid black;"></div> </div> Largo / wide / Longueur 700: Largo / wide / Longueur 1320:			

Serie / Series / Série **LO SOFT AIR**

+Info: [www.infrico.com](http://www.infrico.com)



L07900



L03902



# Armario expositor heladería y pastelería (No-Frost) / Exhibiting cupboard for ice-cream and pastry (No-Frost) / Armoire d'exposition pour la glace et la pâtisserie (No-Frost)

## A DESTACAR

Este sistema de refrigeración permite la inserción en la misma vitrina, tanto productos de pastelería como de heladería, simplemente regulando la temperatura del termostato.

Exposición desde 1 hasta 4 caras en cristal.

Organización interior compuesta de 5 parrillas por puerta, regulables en altura, excepto el Modelo LO 3701VNP con 6 estantes giratorios en cristal.

Estantes interiores en rejilla cromada de 530x450 mm.

Estantes interiores en rejilla cromada de 730x450 mm. [ancho 900].

Estantes giratorios de diámetro 460 mm [Mod. LO3701VNP].

Ruedas en todos los modelos.

Iluminación interior LED.

## BENEFITS

This refrigeration system allows insertion in the display of bakery products as well as ice cream, simply regulating the temperature of the thermostat.

Exhibit of 1 to 4 glass sides.

Interior organisation made up of 5 glass shelves by door, able to regulate in height, except Model LO 3701VNP with 6 rotating shelves in glass.

Interior shelves in chrome grill of 530x450 mm.

Interior shelves in chrome grill of 730x450 mm. [width 900].

Rotating shelved with a 460 diameter [Mod. LO3701VNP].

Castors in all of the models.

LED lighting.

## À SOULIGNER

Ce système permet d'utiliser l'armoire, à la fois, pour pâtisserie et glaces, en modifiant simplement la température du thermostat

Quatre faces vitrées.

5 grilles par porte, réglables en hauteur sauf modèle LO3701VNP avec 6 étagères tournantes en verre.

Étagères intérieures chromées de 530x450mm.

Étagères intérieures chromées de 730x450mm. [largeur 900].

Étagères tournantes de 460 mm de diamètre [Mod. LO3701VNP].

Roulettes sur tous les modèles.

Éclairage intérieur LED.



MODELO/MODELE/MODÈLE	LO3500VNP	LO3700VNP	LO3701VNP	LO7703VNP	LO9311VNP	LO9314VNP	LO9324VNP
<b>Precio</b> Price Prix							
<b>Medidas</b> Measures (mm) Mesures	700 650 1900	700 650 1900	700 650 1900	1320 650 1900	900 650 1900	900 650 1900	1720 650 1900
<b>Tensión/Frecuencia</b> Electrical data [V/Hz] Tension électrique	220/50						
<b>Material</b> Material Matériel	Estructura en aluminio anodizado con decoración de serie en Plata. Anodised aluminium structure with round forms, and with silver series decorations. Structure en aluminium anodisé avec décoration en argent de série.						
<b>Capacidad</b> Capacity Capacité	420	420	420	420+420	600	600	600+600
<b>Caras de cristal</b> Glass sides Faces vitrées	1	4	4	4	1	4	4
<b>Puertas</b> Doors Portes	1	1	1	2	1	1	2
<b>Estantes</b> Shelves Étagères	5	5	6 giratorios 6 rotating 6 tournantes	5+5	5	5	5+5
<b>Temperatura</b> Temperature [30°C] Température	+5°C / -20°C						
<b>Condensación</b> Condensation Condenseur	Ventilada / Ventilated / Ventilée						
<b>Evaporación</b> Evaporation Évaporateur	Ventilada / Ventilated / Ventilée						
<b>Desescarche</b> Defrost [Kg.] Dégivrage	Automático / Automatic / Automatique						
<b>Compresor</b> Compressor Compresseur	1	1	1	1+1	1	1	1+1
<b>Potencia</b> Power [W] Puissance	912	952	982	1824	865	905	1730
<b>Refrigerante</b> Refrigerant Gaz	R290						
<b>Opcional</b> Optional Options	Acabado blanco o negro / White or black finish / Finition noir ou blanc  Largo / wide / Longueur 700: Largo / wide / Longueur 1320:				Acabado blanco o negro / White or black finish / Finition noir ou blanc  Largo / wide / Longueur 900: Largo / wide / Longueur 1720:		

Serie / Series / Série **LO (No-Frost)**

+Info: [www.infrico.com](http://www.infrico.com)



LO 7703 VNP



LO 3500 VNP



L09324VNP



L09311VNP



# Armario expositor para heladería / Exhibiting cupboard for ice-cream / Armoire d'exposition pour la glace

## A DESTACAR

Sistema NO-FOG antiempañamiento en la puerta.  
Iluminación con doble tira de LED con luz continua, mejora la visibilidad del producto expuesto.  
Estantes no regulables en altura, con 4 niveles en el modelo [S] y 5 niveles en el modelo [L].  
Disponible en 4 caras de cristal con terminación de serie en SILVER QUARTZ.

## BENEFITS

NO-FOG anti-glare system on the door.  
Double LED strip lighting with continuous light, improves the visibility of the exposed product.  
Shelves not adjustable in height, with 4 levels in the model [S] and 5 levels in the model [L].  
Available in 4 sides of glass with standard decoration in SILVER QUARTZ.

## À SOULIGNER

Système NO-FOG dans les portes (Glaces et No-Frost).  
Étagères non réglables en hauteur, 4 niveaux en modèle [S] et 5 niveaux en modèle [L].  
Thermostat SOFT TOUCH avec écran graphique de 2.8" avec clavier tactile interactif.  
Roulettes sur tous les modèles.  
Quatre faces vitrées.  
Finition standard SILVER QUARTZ.



MODELO/MODELE/MODÈLE  
**L06114S**



**L06114L**



**L08114S**



**L08114L**

MODELO/MODELE/MODÈLE	L06114S	L06114L	L08114S	L08114L
<b>Precio</b> Price Prix				
<b>Medidas</b> Measures [mm] Mesures	650 650 1500	650 650 1900	850 650 1500	850 650 1900
<b>Tensión/Frecuencia</b> Electrical data [V/Hz] Tension électrique	220/50			
<b>Material</b> Material Matériel	Triple cristal sin perifería de aluminio, cristal exterior e interior bajo emisivo. Triple glass without aluminum profiles, exterior glass and low emissive interior. Triple vitrage avec verres à faible émissivité.			
<b>Capacidad</b> Capacity Capacité	300	450	450	600
<b>Caras de cristal</b> Glass sides Faces vitrées	4	4	4	4
<b>Puertas</b> Doors Portes	1	1	1	1
<b>Estantes</b> Shelves Étagères	4 fijos 4 fixed 4 fixes	5 fijos 5 fixed 5 fixes	4 fijos 4 fixed 4 fixes	5 fijos 5 fixed 5 fixes
<b>Temperatura</b> Temperature [30°C] Température	-15°C / -24°C			
<b>Condensación</b> Condensation Condenseur	Ventilada / Ventilated / Ventilée			
<b>Evaporación</b> Evaporation Évaporateur	Estática / Static / Statique			
<b>Desescarche</b> Defrost [Kg.] Dégivrage	Manual/ Manual / Manuel			
<b>Potencia</b> Power [W] Puissance	501	719	632	829
<b>Refrigerante</b> Refrigerant Gaz	R290			
<b>Opcional</b> Optional Options	Acabado blanco o negro / White or black finish / Finition noir ou blanc  Mod. L650mm x H1500mm:      Mod. L850mm x H1500mm: Mod. L650mm x H1900mm:      Mod. L850mm x H1900mm:  Modelos con 1,2,3 caras de cristal.      Models 1,2,3 faces of glass.      Modèles avec 1,2,3 faces vitrées. Barra iluminación LED adicional      Additional LED strip      Éclairage LED supplémentaire. Módulo para canalizar      Modular model      Module canalisable.			

Serie / Series / Série **VITRA**

+Info: [www.infrico.com](http://www.infrico.com)



[850mm longitud,  
altura 1900mm]  
[850mm width,  
height 1900mm]  
[850mm longueur,  
hauteur 1900mm]

**Standard**  
[Silver quartz]

L08114L



[650mm longitud,  
altura 1500mm]  
[650mm width,  
height 1500mm]  
[650mm longueur,  
hauteur 1500mm]

**Standard**  
[Silver quartz]

L06114S



**Blanco perla**  
White pearl  
Blanc perle



**Negro opal**  
Black opal  
Noir opal



**Termostato**  
Soft touch  
Thermostat



# Armario expositor para pastelería / Exhibiting cupboard for pastry / Armoire d'exposition pour pâtisserie

## A DESTACAR

Iluminación con doble tira de LED con luz continua, mejora la visibilidad del producto expuesto.  
Estantes de cristal regulables en altura de medida 510x450mm (mod. 650mm), y de medida 710x450mm (mod. 850mm).  
3 niveles en el modelo S y 5 niveles en el modelo L. Modelo L06215S con 4 estantes de cristal giratorios.  
Modelo L06215L con 6 estantes de cristal giratorios, diámetro del estante 460mm.  
Disponible en 4 caras de cristal con terminación de serie en SILVER QUARTZ.

## BENEFITS

Double LED strip lighting with continuous light, improves the visibility of the exposed product.  
Glass shelves adjustable in height of measurement 510x450mm (mod. 650mm), and of measurement 710x450mm (mod. 850mm).  
3 levels in model S and 5 levels in model L.  
Model L06215S with 4 rotating glass shelves.  
Model L06215L with 6 rotating glass shelves, shelf diameter 460mm.  
Available in 4 sides of glass with standard decoration in SILVER QUARTZ.

## À SOULIGNER

Étagères non réglables en hauteur, 4 niveaux en modèle [S] et 5 niveaux en modèle [L].  
Étagères réglables en hauteur, 510x450mm (mod. 650), et 710x450 (mod. 850).  
3 niveaux (mod. S), et 5 niveaux (mod. L).  
Mod. L06215S avec 4 étagères tournantes en verre, et mod. L06215L avec 6 étagères tournantes en verre, 460mm Ø  
Quatre faces vitrées et finition standard SILVER QUARTZ.

MODELO/MODELE/MODÈLE	L06214S	L06214L	L06215S	L06215L	L08214S	L08214L
<b>Precio</b> Price Prix						
<b>Medidas</b> Measures [mm] Mesures	650 650 1500	650 650 1900	650 650 1500	650 650 1900	850 650 1500	850 650 1900
<b>Tensión/Frecuencia</b> Electrical data [V/Hz] Tension électrique	220/50					
<b>Material</b> Material Matériel	Triple cristal sin periferia de aluminio, cristal exterior e interior bajo emisivo. Triple glass without aluminum profiles, exterior glass and low emissive interior. Triple vitrage avec verres à faible émissivité.					
<b>Capacidad</b> Capacity Capacité	300	450	300	450	450	600
<b>Caras de cristal</b> Glass sides Faces vitrées	4	4	4	4	4	4
<b>Puertas</b> Doors Portes	1	1	1	1	1	1
<b>Estantes</b> Shelves Étagères	3	5	4 giratorios 4 rotating 4 tournantes	6 giratorios 6 rotating 6 tournantes	3	5
<b>Temperatura</b> Temperature [30°C] Température	+2°C / +10°C					
<b>Condensación</b> Condensation Condenseur	Ventilada / Ventilated / Ventilée					
<b>Evaporación</b> Evaporation Évaporateur	Estática / Static / Statique					
<b>Desescarche</b> Defrost [Kg.] Dégivrage	Automático / Automatic / Automatique					
<b>Potencia</b> Power [W] Puissance	365	975	395	1005	365	975
<b>Refrigerante</b> Refrigerant Gaz	R290					
<b>Opcional</b> Optional Options	Acabado blanco o negro / White or black finish / Finition noir ou blanc <div style="display: flex; justify-content: center; gap: 20px;"> <div style="width: 20px; height: 20px; background-color: black; border: 1px solid black;"></div> <div style="width: 20px; height: 20px; background-color: white; border: 1px solid black;"></div> </div> Mod. L650mm x H1500mm: Mod. L650mm x H1900mm:  Mod. L850mm x H1500mm: Mod. L850mm x H1900mm:					



Serie / Series / Série **VITRA**

+Info: [www.infrico.com](http://www.infrico.com)

**(650mm longitud,  
altura 1500mm)**  
**(650mm width,  
height 1500mm)**  
**(650mm longueur,  
hauteur 1500mm)**



L06215S



L06214L

**(650mm longitud,  
altura 1900mm)**  
**(650mm width,  
height 1900mm)**  
**(650mm longueur,  
hauteur 1900mm)**



# Armario expositor SOFT AIR pastelería [opcional chocolate y bombones] / Exhibiting cupboard pastry SOFT AIR [chocolates optional] / Armoire d'exposition pâtisserie SOFT AIR [en option pour le chocolat et les bonbons]

## A DESTACAR

Línea de vitrinas con refrigeración ventilada, con régimen de temperatura -2°C a +15°C.  
Estantes de cristal regulables en altura de medida 510x450mm, modelos de longitud 650mm y de medida 710x450mm, modelos de longitud 850mm, 3 niveles en el modelo "S" y 5 niveles en el modelo "L".  
Disponible en 4 caras de cristal con terminación de serie en SILVER QUARTZ.  
Iluminación interior LED.

## BENEFITS

Line of showcases with ventilated cooling, with temperature range -2°C to +15°C.  
Glass shelves adjustable in height of measurement 510x450mm, models of length 650mm and of measurement 710x450mm, models of length 850mm, 3 levels in model "S" and 5 levels in model "L".  
Available in 4 sides of glass with standard decoration in SILVER QUARTZ.  
Interior LED lightning.

## À SOULIGNER

Ligne de vitrines à refroidissement ventilée, avec régime de température +15°C à +18°C.  
Étagères réglables en hauteur, 510x450mm [mod. largeur 650], et 710x450 [mod. largeur 850].  
3 niveaux [mod. S], et 5 niveaux [mod. L].  
Quatre faces vitrées et finition standard SILVER QUARTZ.  
Éclairage LED intérieur.

MODELO/MODELE/MODÈLE	L06414S	L06414L	L08414S	L08414L
<b>Precio</b> Price Prix				
<b>Medidas</b> Measures [mm] Mesures	650 650 1500	650 650 1900	850 650 1500	850 650 1900
<b>Tensión/Frecuencia</b> Electrical data [V/Hz] Tension électrique	220-240/50			
<b>Material</b> Material Matériel	Triple cristal sin perifería de aluminio, cristal exterior e interior bajo emisivo. Triple glass without aluminum profiles, exterior glass and low emissive interior. Triple vitrage avec deux verres à faible émissivité.			
<b>Capacidad</b> Capacity Capacité	300	450	450	600
<b>Caras de cristal</b> Glass sides Faces vitrées	4	4	4	4
<b>Puertas</b> Doors Portes	1	1	1	1
<b>Estantes</b> Shelves Étagères	3	5	3	5
<b>Temperatura</b> Temperature [30°C] Température	-2°C / +15°C			
<b>Condensación</b> Condensation Condenseur	Ventilada / Ventilated / Ventilée			
<b>Evaporación</b> Evaporation Évaporateur	Ventilada / Ventilated / Ventilée SOFT AIR			
<b>Desescarche</b> Defrost [Kg.] Dégivrage	Automático / Automatic / Automatique			
<b>Potencia</b> Power [W] Puissance	922	922	997	997
<b>Refrigerante</b> Refrigerant Gaz	R290			
<b>Opcional</b> Optional Options	Opción chocolate y bombones / Chocolate option / Chocolate et bonbons en option Temp: +15°C / +18°C [40% / 60% HR]			
	Opción quesos / Cheese option / Option fromages			
	Acabado blanco o negro / White or black finish / Finition noir ou blanc <div style="display: flex; justify-content: space-around;"> <div style="display: flex; align-items: center;"> <div style="width: 15px; height: 15px; background-color: black; margin-right: 5px;"></div> <span>Mod. L650mm x H1500mm:</span> </div> <div style="display: flex; align-items: center;"> <div style="width: 15px; height: 15px; background-color: white; margin-right: 5px;"></div> <span>Mod. L650mm x H1900mm:</span> </div> <div style="display: flex; align-items: center;"> <div style="width: 15px; height: 15px; background-color: black; margin-right: 5px;"></div> <span>Mod. L850mm x H1500mm:</span> </div> <div style="display: flex; align-items: center;"> <div style="width: 15px; height: 15px; background-color: white; margin-right: 5px;"></div> <span>Mod. L850mm x H1900mm:</span> </div> </div>			

Serie / Series / Série **VITRA SOFT AIR**

+Info: [www.infrico.com](http://www.infrico.com)

(650mm longitud,  
altura 1900mm)  
(650mm width,  
height 1900mm)  
(650mm longueur,  
hauteur 1900mm)



L06414L



L08414L

(850mm longitud,  
altura 1500mm)  
(850mm width,  
height 1500mm)  
(850mm longueur,  
hauteur 1500mm)



# Armario expositor para heladería-pastelería NO-FROST / Exhibiting cupboard for ice-cream and pastry NO-FROST / Armoire d'exposition pour la glace et la pâtisserie NO-FROST

## A DESTACAR

Fabricado en triple cristal sin perfilera de aluminio, cristal exterior e interior bajo emisivo. Sistema NO-FOG antiempañamiento en la puerta. Iluminación con doble tira de LED con luz continua, mejora la visibilidad del producto expuesto. Estantes de cristal regulables en altura de medida 510x450mm [mod. 650mm], y de medida 710x450mm [mod. 850mm]. 3 niveles en el modelo S y 5 niveles en el modelo L. Modelo L06315S con 4 estantes de cristal giratorios. Modelo L06315L con 6 estantes de cristal giratorios, diámetro del estante 460mm. Disponible en 4 caras de cristal con terminación de serie en SILVER QUARTZ.

## BENEFITS

Made of triple glass without aluminum profiles, exterior glass and low emissive interior. NO-FOG anti-glare system on the door. Double LED strip lighting with continuous light, improves the visibility of the exposed product. Glass shelves adjustable in height of measurement 510x450mm [mod. 650mm], and of measurement 710x450mm [mod. 850mm]. 3 levels in model S and 5 levels in model L. Model L06315S with 4 rotating glass shelves. Model L06315L with 6 rotating glass shelves, shelf diameter 460mm. Available in 4 sides of glass with standard decoration in SILVER QUARTZ.

## À SOULIGNER

Fabriquée en triple vitrage avec deux verres à faible émissivité. Système NO-FOG dans les portes. Étagères non réglables en hauteur, 4 niveaux en modèle [S] et 5 niveaux en modèle [L]. Étagères réglables en hauteur, 510x450mm [mod. 650], et 710x450 [mod. 850]. 3 niveaux [mod. S], et 5 niveaux [mod. L]. Mod. L06315S avec 4 étagères tournantes en verre, et mod. L06315L avec 6 étagères tournantes en verre, 460mm Ø. Quatre faces vitrées et finition standard SILVER QUARTZ.

MODELO/MODELE/MODÈLE	L06314S	L06314L	L06315S	L06315L	L08314S	L08314L
<b>Precio</b> Price Prix						
<b>Medidas</b> Measures [mm] Mesures	650 650 1500	650 650 1900	650 650 1500	650 650 1900	850 650 1500	850 650 1900
<b>Tensión/Frecuencia</b> Electrical data [V/Hz] Tension électrique	220/50					
<b>Material</b> Material Matériel	Triple cristal sin perfilera de aluminio, cristal exterior e interior bajo emisivo. Triple glass without aluminum profiles, exterior glass and low emissive interior. Triple vitrage avec deux verres à faible émissivité.					
<b>Capacidad</b> Capacity Capacité	300	450	300	450	450	600
<b>Caras de cristal</b> Glass sides Faces vitrées	4	4	4	4	4	4
<b>Puertas</b> Doors Portes	1	1	1	1	1	1
<b>Estantes</b> Shelves Étagères	3	5	4 giratorios 4 rotating 4 tournantes	6 giratorios 6 rotating 6 tournantes	3	5
<b>Temperatura</b> Temperature [30°C] Température	+5°C / -20°C					
<b>Condensación</b> Condensation Condenseur	Ventilada / Ventilated / Ventilée					
<b>Evaporación</b> Evaporation Évaporateur	Ventilada / Ventilated / Ventilée					
<b>Desescarche</b> Defrost [Kg.] Dégivrage	Automático / Automatic / Automatique					
<b>Potencia</b> Power [W] Puissance	833	997	863	1027	991	1415
<b>Refrigerante</b> Refrigerant Gaz	R290					
<b>Opcional</b> Optional Options	Acabado blanco o negro / White or black finish / Finition noir ou blanc <div style="display: flex; justify-content: center; gap: 10px;"> <div style="width: 20px; height: 20px; background-color: black; border: 1px solid black;"></div> <div style="width: 20px; height: 20px; background-color: white; border: 1px solid black;"></div> </div> Mod. L650mm x H1500mm: Mod. L650mm x H1900mm:  Mod. L850mm x H1500mm: Mod. L850mm x H1900mm:					

Serie / Series / Série **VITRA NO-FROST**

+Info: [www.infrico.com](http://www.infrico.com)

(650mm longitud,  
altura 1900mm)  
(650mm width,  
height 1900mm)  
(650mm longueur,  
hauteur 1900mm)

Negro/Black/Noir  
**Opcional**  
Optional  
Option



L06314L

(650mm longitud,  
altura 1900mm)  
(650mm width,  
height 1900mm)  
(650mm longueur,  
hauteur 1900mm)



L06314L



# Murales calientes / Hot display cabinet / Murale d'exposition chaude

## A DESTACAR

Tecnología de doble recuperación y circulación del aire caliente para un correcto mantenimiento de los productos envasados.

Sistema de cortina de aire caliente en el frontal así como en cada balda que dispone de una regulación y ventilación del aire caliente.

Costados laterales panorámicos con efecto espejo.

Tope de fijación del cristal frontal templado en cada estante para evitar la caída del producto.

Facilidad de desplazamiento al disponer de 4 ruedas, dos con freno.

Termostato digital regulable entre 20°C a 90°C para el mantenimiento del producto a temperatura reglamentaria de 63°C al corazón del producto. Norma HACCP.

Iluminación mediante tubo led en la parte posterior a ambos lados.

HDC60L: 5 Niveles de exposición en INOX [ 4 estantes + cuba] no regulables en altura e inclinación con superficie de exposición 580x480mm.

HDC100S: 3 Niveles de exposición en INOX [2 estantes + cuba] no regulables en altura e inclinación con superficie de exposición 980x480mm.

HDC100L: 5 Niveles de exposición en INOX [ 4 estantes + cuba] no regulables en altura e inclinación con superficie de exposición 980x480mm.

## BENEFITS

Double recovery technology and hot air circulation for a correct maintenance of the packaged products.

Hot air curtain system on the front, as well as on each shelf, with hot air regulation and ventilation.

Panoramic side panels with mirror effect.

Tempered front glass fixing stop on each shelf to prevent the product from falling.

Easy to move as it has 4 castors, two with brakes.

Digital thermostat adjustable from 20°C to 90°C to maintain the product at the regulatory temperature of 63°C at the heart of the product. HACCP Standard.

Illumination by LED tube at the back on both sides.

HDC60L: 5 stainless steel display levels (4 shelves + tank) not adjustable in height and inclination with display surface 580x480mm.

HDC100S: 3 stainless steel display levels (2 shelves + tank) not adjustable in height and inclination with display surface 980x480mm.

HDC100L: 5 stainless steel display levels (4 shelves + tank) not adjustable in height and inclination with a 980x480mm display surface.

## Á SOULIGNER

Double technologie de récupération et circulation d'air chaud pour un entretien correct des produits emballés.

Système de rideau d'air chaud à l'avant, ainsi que sur chaque étagère, avec régulation et ventilation de l'air chaud.

Panneaux latéraux panoramiques avec effet miroir.

Butée de fixation en verre trempé sur chaque étagère pour empêcher le produit de tomber.

Facile à déplacer car il possède 4 roues, dont deux avec freins.

Thermostat numérique réglable de 20°C à 90°C pour maintenir le produit à la température réglementaire de 63°C au cœur du produit. Norme HACCP.

Illumination par tube LED à l'arrière, sur les deux côtés.

HDC60L : 5 niveaux d'affichage INOX [4 étagères + réservoir] non réglables en hauteur et en inclinaison avec une surface d'affichage de 580x480mm.

HDC100S : 3 niveaux d'affichage INOX [2 étagères + réservoir] non réglables en hauteur et en inclinaison avec surface d'affichage 980x480mm.

HDC100L : 5 niveaux d'affichage INOX [4 étagères + réservoir] non réglables en hauteur et en inclinaison avec surface d'affichage 980x480mm.



HDC 60 L



HDC 100 S



HDC 100 L

MODELO/MODELE/MODÈLE	HDC 60 L	HDC 100 S	HDC 100 L
Precio Price Prix			
Medidas Measures [mm] Mesures	604 x 812 x 1973	1005 x 812 x 1529	1005 x 790 x 1970
Temperatura Temperature Température	<b>+63°C</b>		
Tensión/Frecuencia Electrical data Tension électrique	230/1ph/20A	400/3ph/9A	400/3ph/21A
Material Material Matériel	Exterior: acero lacado negro / Interior: acero Inox / Trasera: Inox sin puerta Exterior: black lacquered stainless / Interior: stainless steel / Back: stainless steel without door. Extérieur: acier laqué noir / Intérieur: acier inox / Arrière: acier inox sans porte		
Niveles de exposición Exposure levels Niveaux d'exposition	5	3	5
Iluminación Lighting Éclairage	Barras laterales en Led / Led sidebars / Barres laterales Led		
Control temperatura Temp. control Contrôle de la températ.	Digital		
Consumo instantáneo Instant. consumption Consommation instant.	4,5	6,3	8,3
Consumo medio Average consumption Consommation moyenne	2,3	3,1	4,1
Opcional Optional Options	Opción 60Hz		

Serie / Series / Série **HDC**

HDC 100 L



HDC 100 S



**Doble recuperación y circulación del aire caliente**  
 Double recovery technology and hot air circulation  
 Double technologie de récupération et circulation d'air chaud

**Doble iluminación lateral LED**  
 LED light at the back on both sides

Double éclairage LED à l'arrière, sur les deux côtés

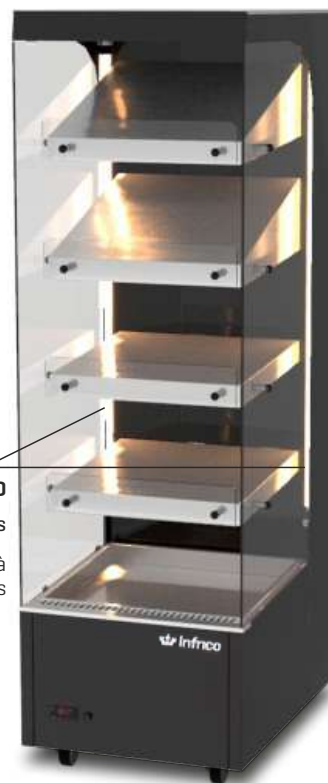

HDC 60 L



**Carros calientes de distribución /**  
**Heated banquet trolleys /**  
**Chariot distributeur maintien au chaud**



MODELO/MODELE/MODELE	HT1021	HT2021	HT4021
<b>Precio</b> Price Prix			
<b>Medidas</b> Measures [mm] Mesures	910 827 1160	910 827 1816	910 1517 1816
<b>Tensión/Frecuencia</b> Electrical data [V/Hz] Tension électrique	230V/50-60Hz		
<b>Material</b> Material Matériel	Ext: Chapa galvanizada plastificada blanco / Galvanised steel white plastic coated / Tôle galvanisée plastifiée blanc. Int: Cuba interior en aluminio / Aluminium inner tank / Cuve intérieure en aluminium		
<b>Capacidad</b> Capacity Capacité [L]	310	550	1300
<b>Nº Guías</b> Nº Slides Nº Guides	5 GN2/1	11 GN2/1 22 GN1/1	11+11 GN2/1 22+22 GN1/1
<b>Puerta</b> Door Porte	1 puerta ciega abatible 270º apertura 1 hinged blind door, 270º opening 1 porte aveugle, battant 270º		
<b>Temperatura</b> Temperature [32ºC] Température	<b>+50°C / +80°C</b>		
<b>Distancia entre bandejas</b> Distance between trays Distance entre bacs	57mm		
<b>Cajón calefactor</b> Heating drawer Tiroir chauffant	Extraíble con resistencia y depósito de agua Removable with heating element and water tank Amovible avec élément chauffant et réservoir d'eau		
<b>Vapor</b> Steam Vapeur	No		
<b>Control digital</b> Digital control Contrôle numérique	Temperatura / Alarmas HACCP Temperature / HACCP Alarms Température / Alarmes HACCP		
<b>Potencia</b> Power Puissance [W]	2.000		
<b>Opcional</b> Optional Options	Parrillas / Grills / Grilles		



**NEW**

Serie / Series / Série **HT**



HT2021



HT4021



# Horno microondas profesional / Professional microwave oven / Four micro-ondes professionnel

## A DESTACAR

Capacidad útil 34L. Para bandejas GN 2/3 y platos de gran diámetro.

**HM1001M:** Dispone de dial temporizador electrónico con función AutoReset, manual sin programas. 5 niveles de potencia. Guía de menú para elementos de uso frecuente.

**HM1401P / HM1802P:** Modelos digitales de membrana táctil. Funcionamiento manual o con programas. 5 niveles de potencia y 3 etapas de cocción. Tiempo de cocción máximo de 60 minutos y 100 programas automáticos. Opción de ingreso de tiempo y botón de cantidad múltiple x2 que permite cocinar diferentes porciones.

**HM1001M y HM1401P** con magnetrón y antena giratoria inferior.

**HM1802P** con dos magnetrones, dos antenas giratorias inferior y superior. Iluminación de la cámara. Señal acústica de final de ciclo de cocción. Posibilidad de montaje apilado de dos microondas [x2].

Filtro de aire en la parte frontal.

## BENEFITS

Useful capacity 34L. GN 2/3 trays or large diameter plates.

**HM1001M:** 6 minute electronic timer dial with AutoReset function, manual without programs. 5 power levels by turning the dial counterclockwise. Menu guide for frequently used items.

**HM1401P / HM1802P:** Digital models of touch membrane. Manual operation or with programs. 5 power levels and three cooking stages. Maximum cooking time of 60 minutes and 100 automatic programs. Time entry option and multiple quantity button x2 that allows cooking different portions.

**HM1001M / HM1401P** with a magnetron, with a lower rotating antenna.

**HM1802P** with two magnetrons, with two lower and upper rotating antennas. Camera lighting. Acoustic signal at the end of the cooking cycle. Possibility of stacking two microwaves [x2]. Front air filter.

## À SOULIGNER

Capacité utile 34L. Plateaux GN 2/3 ou des plaques de grand diamètre.

**HM1001M:** minuterie électronique, 6 minutes avec AutoReset, manuel sans programmes. 5 niveaux de puissance. Notice des différents menus pour les éléments les plus fréquemment utilisés.

**HM1401P/HM1802P:** Mod. numériques à membrane tactile à fonctionnement manuel ou programmable. 5 niveaux de puissance, 3 niveaux de cuisson. Temps de cuisson maximum de 60 minutes et 100 programmes automatiques. Option: saisie du temps et bouton qui multiplie par 2 la quantité permettant de cuire différentes portions.

**HM1001M/HM1401P** avec magnétron et antenne rotative inférieure.

**HM1802P** Deux magnétrons, deux antennes rotatives inférieures et supérieures. Eclairage intérieur. Alarme de fin de cycle. Possibilité de superposer 2 micro-ondes. Filtre à air frontal.

MODELO/MODELE/MODÈLE	HM1001M	HM1401P	HM1802P
<b>Precio</b> Price Prix			
<b>Medidas</b> Measures [mm] Mesures	EXT: 553x488(494)x343 INT: 370x385x230	EXT: 553x488(494)x343 INT: 370x385x230	EXT: 574x528(535)x368 INT: 360x409x225
<b>Tensión/Frecuencia</b> Electrical data [V/Hz] Tension électrique	220/50		
<b>Material</b> Material Matériel	Ext/Int: acero inoxidable Ext/Int: stainless steel Ext/Int: acier inoxydable		
<b>Magnetrones</b> Magnetrons Magnétrons	1	1	2
<b>Niveles potencia</b> Power levels Niveaux de puissance	5	5	5
<b>Etapas de cocción</b> Cooking stages Étapes de la cuisson	1	3	3
<b>Tipo de control</b> Control type Type de contrôle	Dial / Dial / Cadran	Membrana Táctil /Tactil membrane / Membrane tactile	
<b>Descongel. por tiempo</b> Defrosting by time Dégivrage par le temps	No	Sí/Yes/Oui	
<b>Opción ingreso tiempo</b> Time input option Option de saisi des temps	Sí/Yes/Oui		
<b>Máx. tiempo cocción</b> Max. cooking time [min] Temps cuisson max.	6	60	
<b>Ajuste porción múltiple</b> Multiple portion settings Possibilité plusieurs portions	No	Sí/Yes/Oui x 2	
<b>Ajuste porción múltiple</b> Multiple portion settings Possibilité plusieurs portions	Tiempo/Time/Temps	Tiempo-Programas/Time-Programs/Temps-Programmes	
<b>Función cocción express</b> Express cooking function Fonction cuisson express	Sí/Yes/Oui		
<b>Potencia</b> Power Puissance [W]	1000	1400	1800
<b>Consumo</b> Consumption Consommation [W]	1600	1900	2800
<b>Opcional</b> Optional Options	-		

Serie / Series / Série **MICROONDAS**

+Info: [www.infrico.com](http://www.infrico.com)



HM1001M



HM1401P

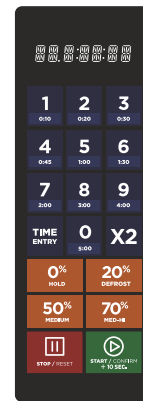

HM1802P

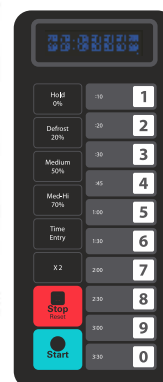

**Horno eléctrico para panadería / Electric bakery oven / Fours pour la boulangerie**

Serie / Series / Série **HE**

**Armario caliente fermentador / Fermentation ovens / Armoire de fermentation**

Serie / Series / Série **FERMENTADOR**

**A DESTACAR (HE)**

Puerta con doble cristal serigrafiado en color gris con tirador y apertura batiente.  
Termostato seguridad.  
Iluminación interior.

**BENEFITS (HE)**

Double glass door with grey stamped color and integrated handle.  
Security thermostat.  
Interior lighting.

**À SOULIGNER (HE)**

Porte avec double vitrage sérigraphié en gris avec poignée et ouverture à charnière.  
Thermostat de sécurité.  
Éclairage intérieur.

**A DESTACAR (FERMENTADOR)**

Puerta abatible de cristal.  
Recipiente disponible para depositar agua y aportar humedad.

**BENEFITS (FERMENTADOR)**

Self-closing glass door.  
Available water deposit and humidity kit.

**À SOULIGNER (FERMENTADOR)**

Porte battante en verre.  
Récipient disponible pour déposer de l'eau et fournir de l'humidité.

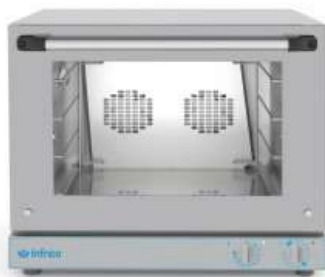

HE304



HE424



F 848

**HORNOS HE**

**FERMENTADOR**

MODELO/MODELE/MODÈLE	HE304	HE424	HE424G	F848
<b>Precio</b> Price Prix				
<b>Medidas</b> Measures [mm] Mesures	EXT: 590x675x540 INT: 450x340x345	EXT: 640x720x540 INT: 500x410x345	EXT: 640x720x540 INT: 500x410x345	640 640 975
<b>Tensión/Frecuencia</b> Electrical data [V/Hz] Tension électrique	230V-50-60Hz			
<b>Material</b> Material Matériel	Ext/Int: <b>acero inoxidable</b> Ext/Int: stainless steel Ext/Int: acier inoxydable			
<b>Temperatura</b> Temperature Température	<b>+50°C / +250°C</b>			<b>30°C / +85°C</b>
<b>Capacidad</b> Capacity Capacité	4 bandejas/trays/bacs 430x340 4GN2/3	4 parrillas/shelves/grilles 480x340 4GN2/3	4 parrillas/shelves/grilles 480x340 4GN2/3	8 trays 480x340
<b>Grill</b> Electrical Grill Grill	-	-	Serie/Series/Série	-
<b>Kit bandejas GN</b> GN Trays kit Kit bacs GN	Serie/Series/Série			-
<b>Espacio entre bandejas</b> Shelves distance Espace entre les grilles	80 mm			-
<b>Temporizador</b> Timer Minuterie	0-120 min. Modo continuo / Continuous mode / Mode continu Alarma fin de ciclo / Cycle alarm / Alarme pour fin de cycle			-
<b>Motor</b> Engine Moteur	2			-
<b>Potencia</b> Power Puissance [W]	3100W	3100W	3100W	700
<b>Opcional</b> Optional Options	<b>Apertura puerta lateral / Door side opening / Ouverture porte latérale</b> <b>Consultar/To consult/Consulter</b> <b>Humidificador / Humidity kit / Humidificateur</b> <b>Soporte horno HE424 [8 guías] / Hold up over HE424 [8 slides] / Support four HE424 [8 glissières]</b>			-

**Horno eléctrico para panadería 600x400 / Electric bakery oven 600x400 / Fours pour la boulangerie 600x400**

**Serie / Series / Série HE 600x400**

**Armario caliente fermentador / Fermentation ovens / Armoire de fermentation**

**Serie / Series / Série FERMENTADOR**

**A DESTACAR (HE 600x400)**

Puerta con doble cristal serigrafiado en color gris con tirador y apertura batiente. Termostato seguridad. Iluminación interior. Micro de puerta (en modelos HE604/604PLUS/HE604PLUSG).

**BENEFITS (HE 600x400)**

Double glass door with grey stamped color and integrated handle. Security thermostat. Interior lighting. Micro Switch on the door (models HE604/HE604PLUS/ HE604PLUSG).

**À SOULIGNER (HE 600x400)**

Porte avec double vitrage sérigraphié en gris avec poignée et ouverture à charnière. Thermostat de sécurité. Éclairage intérieur. Microrupteur sur la porte (modèles HE604/HE604PLUS/HE604PLUSG).

**A DESTACAR (FERMENTADOR)**

Puerta abatible de cristal. Recipiente disponible para depositar agua y aportar humedad.

**BENEFITS (FERMENTADOR)**

Self-closing glass door. Availabel water deposit and humidity kit.

**À SOULIGNER (FERMENTADOR)**

Porte battante en verre. Récipient disponible pour déposer de l'eau et fournir de l'humidité.

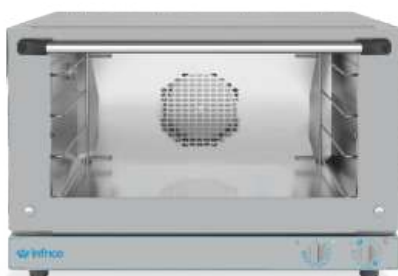

HE604



HE604PLUS

**HORNOS HE 600x400**



F 860

**FERMENTADOR**

MODELO/MODELE/MODÈLE	HE603	HE604	HE604PLUS	HE604PLUSG	F860
<b>Precio</b> Price Prix					
<b>Medidas</b> Measures (mm) Mesures	EXT: 760x800x465 INT: 620x450x270	EXT: 760x800x545 INT: 620x450x350	EXT: 760x800x545 INT: 620x450x350	EXT: 760x800x545 INT: 620x450x350	820 700 975
<b>Tensión/Frecuencia</b> Electrical data (V/Hz) Tension électrique	230V-50-60Hz	400/230V-50-60Hz			230V-50-60Hz
<b>Material</b> Matériel	Ext/Int: <b>acero inoxidable</b> Ext/Int: <b>stainless steel</b> Ext/Int: <b>acier inoxydable</b>				
<b>Temperatura</b> Temperature Temperature	<b>+50°C / +250°C</b>				<b>30°C / +85°C</b>
<b>Capacidad</b> Capacity Capacité	3 parrillas/shelves/grilles (600x400)	4 parrillas/shelves/grilles (600x400) 4GN 1/1	4 parrillas/shelves/grilles (600x400) 4GN 1/1	4 parrillas/shelves/grilles (600x400) 4GN 1/1	8 trays 600x400
<b>Grill</b> Electrical Grill Grill	-	-	-	Serie/Series/Série	-
<b>Kit bandejas GN</b> GN Trays kit Kit bacs GN	-	Serie/Series/Série			-
<b>Espacio entre bandejas</b> Shelves distance Espace entre les grilles	80 mm				-
<b>Temporizador</b> Timer Minuterie	0-120 min. Modo continuo / Continuous mode / Mode continu Alarma fin de ciclo / Cycle alarm / Alarme pour fin de cycle				-
<b>Motor</b> Engine Moteur	1		2		-
<b>Potencia</b> Power Puissance	[W] 3900W	5700W	6300W	6300W	1400
<b>Opcional</b> Optional Options	<b>Apertura puerta lateral / Door side opening / Ouverture porte latérale</b> <b>Consultar/To consult/Consulter</b> <b>Humidificador / Humidity kit / Humidificateur</b> <b>Soporte horno HE603/604/604PLUS / Hold up over HE603/604/604PLUS / Support four HE603/604/604PLUS</b>				-



**Invasadora al vacío de aspiración externa /**  
**External aspiration vacuum packaging machine /**  
**Machine sous vide à aspiration extérieure.**

Serie / Series / Série **VACE**

**A DESTACAR**

Bomba auto-lubricante.  
 Panel de mandos digital con tres programas establecidos, proceso de embasado automático controlado electrónicamente.  
 Tiempo de vacío regulable, establecido a 15 y 30 segundos con posibilidad de regularlo manualmente.  
 Tiempo de soldadura ajustable de 1 a 7 segundos.  
 Vac stop permite parar en cualquier momento una fase del proceso pasando a la siguiente.  
**Funciona con bolsas gofradas.**

**BENEFITS**

Self-lubricating pump.  
 3 programs set, automatic vacuum process controlled.  
 Removable vacuum time, set from 15 to 30 seconds with manual remove possibility.  
 Vac stop allow stop the machine in time phase of the processes.  
**Embossed bags.**

**À SOULIGNER**

Pompe auto lubrifiante.  
 Commande digitale avec 3 programmes.  
 Contrôle sous vide automatique, réglé à 15 et 30 secondes avec possibilité de réglage manuel.  
 Temps de soudure réglable de 1 à 7 secondes.  
 Vac stop permet d'arrêter à tout moment une phase du processus en passant à la suivante.  
**Il fonctionne avec des sacs gaufrés.**

VACE30



VACE40

**Panel de mandos digital**  
 Digital control  
 Tableau de bord digital

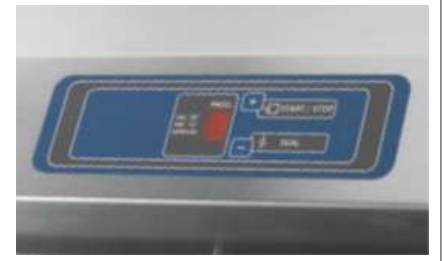

MODELO/MODELE/MODÈLE	VACE30	VACE40
<b>Precio</b> Price Prix		
<b>Medidas</b> Measures [mm] Mesures	385x254x125	485x254x125
<b>Tensión/Frecuencia</b> Electrical data [V/Hz] Tension électrique	220-230/50-60Hz	
<b>Material</b> Material Matériel	Ext/Int: acero inoxidable AISI 304 Ext/Int: stainless steel AISI 304 Ext/Int: acier inoxydable AISI 304	
<b>Capacidad bomba</b> Bomb capacity Pompe à vide	20	40
<b>Longitud soldadura</b> Welding wide Barre de soudure	300	400
<b>Bolsa</b> Bag Sac	Gofrada / Embossed / Gaufré	
<b>Potencia</b> Power Puissance [W]	270	450
<b>Opcional</b> Optional Options	-	

# Máquina termoselladora / Thermosealer machine / Machines thermo-soudeuses

## Serie / Series / Série TSB

### A DESTACAR

Sellado y corte simultaneo del film.  
Sistema de frenado de retroceso del film, facilitando la colocación de las barquetas.  
Modelo TSB150 incluye dos moldes:  
· 1 molde para una barqueta 192x137 mm.  
· 1 molde para dos barquetas 96x137 mm.  
Modelo TSB 290 incluye dos moldes:  
· 1 molde para una barqueta 1/2 GN [320x265 mm].  
· 1 molde para dos barquetas 1/4 GN [265x162 mm].  
El molde para dos barquetas esta provisto de una guía central para facilitar el corte del film.  
Se suministra con bobina de film de de 300 metros de longitud y 150 mm de ancho [TSB150].  
TSB290 no incluye bobina.  
Profundidad máxima de la barqueta 100 mm.

### BENEFITS

Cutting and welding simultaneous.  
Stopping system of film regression helping the positioning.  
Model TSB150 includes:  
· 1 mold for 1 tank 192x137 mm.  
· 1 mold for 2 tanks 96x137 mm.  
Model TSB150 includes:  
· 1 mold for 1 tank 1/2 GN [192x137 mm].  
· 1 mold for 2 tanks 1/4 GN [265x162 mm].  
The mold provide with a centred guide to help cutting the film.  
Provided with Roll 300 m long and 150 mm width [TSB150].  
TSB290 without roll.  
Maximum depth 100 mm.

### À SOULIGNER

Soudure et découpes simultanées.  
Système de frein et retour du film.  
Modèle TSB150 comprend:  
· 1 Moule de dimensions de 192x137 mm.  
· 1 Moule de dimensions de 96x 137 mm.  
Modèle TSB290 comprend:  
· 1 Moule pour barquettes 1/2 GN [320x265 mm].  
· 1 Moule pour barquettes 1/4 GN [265x162 mm].  
Le moule pour deux barquettes est équipé d'une glissière centrale pour faciliter la découpe du film.  
Il est livré sur une bobine de film de 300 mètres de long et 150 mm de large [TSB150].  
Le TSB290 n'a de bobine.  
Profondeur maximale de la barquette: 100mm.



**Bobina de film y dos moldes de serie**

Film roll and two standard moulds

Bobine de film et deux moules de série



TSB290

MODELO/MODELE/MODÈLE	TSB150	TSB290
<b>Precio</b> Price Prix		
<b>Medidas</b> Measures [mm] Mesures	230x500x180	380x650x180
<b>Tensión/Frecuencia</b> Electrical data [V/Hz] Tension électrique	220-230/50-60Hz	
<b>Material</b> Material Matériel	Ext/Int: acero inoxidable AISI 304 Ext/Int: stainless steel AISI 304 Ext/Int: acier inoxydable AISI 304	
<b>Ancho bobina</b> Roll width Largeur bobine	150	200
<b>Potencia</b> Power [W] Puissance	400	1400
<b>Opcional</b> Optional Options	[TSB 150] Bobina de longitud 150 m y ancho 150 mm Provide with Roll 150 m long and 150 mm Bobine de longueur 150 mm et largeur 150 mm.	[TSB 290] Bobina de longitud 200 m y ancho 280 mm Roll 200 m of length and 280 mm Bobine de longueur 200 mm et largeur 280 mm.



# Envasadora al vacío [Tiempo] / Vacuum packaging machine [Time] / Machine sous vide [Temps]

Serie / Series / Série **VACT**

## A DESTACAR

Vacuometro [excepto Mod. VACT6A]. Regulación tiempo de vacío. Regulación tiempo de soldadura. Entrada de atmósfera progresiva. Stop Vacío. Indicador luminoso del proceso activo. Modelos de sobremesa Bomba DVP de alto rendimiento. Modelos de pie Bomba Busch.

## BENEFITS

Vacuum meter [except Mod. VACT6A]. Vacuum gauge time control. Sealing time control. Progressive atmosphere entry. Stop vacuum. Lighting alarm of active process. DVP pump high performance. BUSCH pump in the stand models.

## À SOULIGNER

Vacuomètre [sauf mod. VACT6A]. Réglage temps sous vide. Réglage temps de soudure. Entrée d'atmosphère progressive. Arrêt sous vide. Indicateur lumineux du processus actif. Modèles à poser Pompe DVP haute performance. Modèles sur pieds avec pompe Busch.



VACT 6A



VACT 8A



VACT 12A / VACT 20A

**Cuba embutida**  
Stamped pan  
Cuve emboutie



**Tapa metacrilato transparente con bisagras en acero inox**  
Transparent methacrylate lid with stainless steel hinges.

Couvercle transparent en méthacrylate avec charnières en inox



MODELO/MODELE/MODÈLE	MODELOS SOBREMESA / DESKTOP MODELS / MODÈLES À POSER						MOD. DE PIE / FLOOR MOD. / MOD. SUR PIED		
	VACT6A	VACT8A	VACT12A	VACT20A	VACT20B	VACT20BB	VACT40AB	VACT63AB	VACT100AB
<b>Posición barra soldadura</b> Sealing bar position Position barre de soudure									
<b>Precio</b> Price Prix									
<b>Medidas</b> EXT. INT. Measures Mesures	340x480x325 280x355x90	410x455x360 350x350x120	480x560x440 450x420x180	480x560x440 450x420x180	610x575x440 550x470x180	610x575x440 550x470x180	800x575x1040 680x470x200	800x575x1040 680x470x200	1000x705x1040 880x600x200
<b>Tensión/Frecuencia</b> Electrical data [V/Hz] Tension électrique	220-230/50-60						400/50-60		
<b>Material</b> Material Matériel	Ext/Int: acero inoxidable AISI 304 / Tapa metacrilato Ext/Int: stainless steel AISI 304 / Methacrylate lid Ext/Int: acier inoxydable AISI 304 / Couvercle méthacrylate								
<b>Capacidad bomba</b> Bomb capacity Pompe à vide	6m <sup>3</sup> DVP	8m <sup>3</sup> DVP	12m <sup>3</sup> DVP	20m <sup>3</sup> DVP	20m <sup>3</sup> DVP	20m <sup>3</sup> DVP	40m <sup>3</sup> BUSCH	63m <sup>3</sup> BUSCH	100m <sup>3</sup> BUSCH
<b>Longitud soldadura</b> Welding wide Barre de soudure	270	340	410	410	450	450	580+450	580+450	780+580
<b>Nº Barras soldadura</b> N. welding bars Nº barres de soudure	1						2		
<b>Potencia</b> Power Puissance (W)	260	350	540	750	750	750	1120	1500	2250
<b>Opcional</b> Optional Options	-								



# Envasadora al vacío (Sensor) / Vacuum packaging machine (Sensor) / Machine sous vide (Capteur)

# Serie / Series / Série VACS

## A DESTACAR

50 programas. Regulación porcentual de vacío. Tiempo extra de vacío. Entrada gas inerte regulable porcentualmente. Tiempo de soldadura. Entrada de atmósfera progresiva. Programa especial para el sistema Gastro vac en los modelos de Sobremesa con Bomba DVP. Stop Vacío. Auto-calibración. Bomba Busch de alto rendimiento en modelos con pre-bomba. Entrada Gas inerte de serie. Auto-clean oil, sistema de autolimpieza del aceite de la bomba.

## BENEFITS

50 programmes. Vacuum percentage control. Additional extra vacuum time. Gas entry percentage control. Sealing time control. Special gastro vac programme in with DVP pump. Stop vacuum. High performance BUSH pump in model with pump pre-install. Inert gas standard. Pre-Install gastro vac system for external countriners vacuum. Self-calibration for a perfect vacuum, providing atmosphere presion.

## À SOULIGNER

50 programmes. Réglage partiel du sous vide. Temps extra du sous vide. Temps de soudure. Entrée d'atmosphère progressive. Programme spécial pour le système gastro-vac. Arrêt sous vide avec DVP. Auto-calibrage. Pompe Busch haute performance sur les modèles pré-installé. Système gastro vac pré-installé faire le vide extérieur dans des récipients Gastronorm pour les modèles à poser. Huile auto-nettoyante, système auto-nettoyant pour huile de pompe.



### Barra soldadura sin conexiones con doble soldadura

Welding bar without connections and double welding

Barre de soudure sans connexion (double barres)



VACS 8A



VACS 20BB



VACS 63AB



### MODELOS SOBREMESA / DESLTOP MODELS / MODÈLES À POSER

### MOD. DE PIE / FLOOR MOD. / MOD. SUR PIED

Posición barra soldadura  
Sealing bar position  
Position barre de soudure



MODELO/MODELE/MODÈLE

VACS8A

VACS10A

VACS20A

VACS20B

VACS20BB

VACS40AB

VACS63AB

VACS100AB

MODELO/MODELE/MODÈLE	VACS8A	VACS10A	VACS20A	VACS20B	VACS20BB	VACS40AB	VACS63AB	VACS100AB
<b>Precio</b> Price Prix								
<b>Medidas</b> Measures Mesures	EXT. ↔ INT. ↓	410x455x360	480x560x440	480x560x440	610x575x440	610x575x440	800x575x1040	800x575x1040
<b>Tensión/Frecuencia</b> Electrical data [V/Hz] Tension électrique		220-230/50-60				400/50-60		
<b>Material</b> Material Matériel	Ext/Int: acero inoxidable AISI 304 / Tapa metacrilato Ext/Int: stainless steel AISI 304 / Methacrylate lid Ext/Int: acier inoxydable AISI 304 / Couverture méthacrylate							
<b>Capacidad bomba</b> Bomb capacity Pompe à vide	8m <sup>3</sup> DVP	10m <sup>3</sup> DVP	20m <sup>3</sup> DVP	20m <sup>3</sup> DVP	20m <sup>3</sup> DVP	40m <sup>3</sup> BUSCH	63m <sup>3</sup> BUSCH	100m <sup>3</sup> BUSCH
<b>Longitud soldadura</b> Welding wide Barre de soudure	340	410	410	450	450	580+450	580+450	780+580
<b>Nº Barras soldadura</b> N. welding bars Nº barres de soudure	1				2			
<b>Potencia</b> Power Puissance	[W]	440	540	750	750	750	1120	1500
<b>Opcional</b> Optional Options	Gastro VAC							



# Plancha a gas / Gas griddles / Plancha à gaz

Serie / Series / Série **PG**

## A DESTACAR

### PV:

Encendido con piezo eléctrico. Quemador en forma de herradura con doble salida de llama, logrando una temperatura uniforme en toda la placa. Orificio dispuesto en la placa con cajón recogedor de grasas integrado en el frontal. Válvulas de gas con dos intensidades de calor, máximo y mínimo. Toma de gas por el lateral izquierdo o derecho. Pies regulables en altura.

### NS/NC:

Encendido tren de chispas a batería. Quemador en forma de herradura con doble salida de llama, logrando una temperatura uniforme en toda la placa. Orificio dispuesto en la placa con cajón recogedor de grasas integrado en el frontal. Válvulas de gas con dos intensidades de calor, máximo y mínimo [serie NS] y válvula de gas termostática con regulación de 100°C a 300°C. [serie Cromo duro]. Entrada de gas por la parte trasera derecha, liberando los laterales de conexiones externas. Pies regulables en altura.

## BENEFITS

### PV:

Electric piezo ignition. Burner with double exit flame, obtaining a uniform temperature for controlled cooking. Gas valves with two intensities of heat, maximum and minimum. Gas connection at left or right hand side. Adjustable legs. Hole in the plate with integrated grease trap drawer on the front.

### NS/NC:

Ignition by sparks to battery. Burner with double exit flame, obtaining a uniform temperature for controlled cooking. Intergrated fat collection drawer in the front. Gas valves with two intensities of heat, maximum and minimum [serie NS] and thermostatic gas valves with regulation from 100°C to 300°C [serie Chromo duro]. Gas connection at the back. Adjustable feet.

## À SOULIGNER

### PV:

Allumage électrique. Brûleur en forme de fer à cheval avec double sortie de flamme, pour obtenir une température uniforme sur toute la plaque. Tiroir récupérateur de graisses installé en partie frontale. Valves de gaz avec deux intensités de chaleur, maximum et minimum. Entrée de gaz sur le côté gauche ou droit. Pieds réglables en hauteur.

### NS/NC:

Allumage par étincelles. Brûleur en forme de fer à cheval avec double sortie de flamme, pour obtenir une température uniforme sur toute la plaque. Tiroir récupérateur de graisses installé en partie frontale. Valves de gaz avec deux intensités de chaleur, maximum et minimum [série NS] et valve de gaz thermostatique réglable de 100° à 300°C [série chrome dur]. Entrée du gaz à l'arrière droit laissant libre deux côtés externes pour les connexions. Pieds réglables en hauteur.



MODELO/MODELE/MODÈLE	PG45PV	PG60PV	PG75PV	PG90PV	PG60NS	PG80NS	PG100NS	PG60NC	PG80NC	PG100NC
<b>Precio</b> Price Prix										
<b>Medidas</b> EXT. ↔ Measures Mesures INT. ↓	460 435 190	610 435 190	760 435 190	910 435 190	600 440 180	800 440 180	1000 440 180	600 440 180	800 440 180	1000 440 180
<b>Material</b> Material Matériel	Placa acero pavonado 6mm, negro Treated stainless steel plate 6 mm, black Chrome plate 15 mm, welded splashback				Placa acero laminado 15mm, peto perimetral inox Laminated steel plate 15 mm, welded splashback Chrome plate 15 mm, welded splashback			Placa en cromo duro 15mm, peto perimetral inox Chrome plate 15 mm, welded splashback Chrome plate 15 mm, welded splashback		
<b>Kcal/h</b>	3526	7052	7482	10922	7052	10578	12814	7052	10578	12814
<b>Nº quemadores</b> Nº of burners Nº brûleurs	1	2	2	3	2	3	3	2	3	3
<b>Nº válvulas</b> Nº of valves Nº valves	1	2	2	3	2	3	3	2	3	3
<b>Superficie útil</b> Usable area Surface utile	440x390	590x390	740x390	890x390	595x430	795x430	995x430	595x430	795x430	995x430
<b>Potencia</b> Power Puissance (W)	4100	8200	8700	12700	8200	12300	14900	8200	12300	14900
<b>Opcional</b> Optional Options	-									

# Plancha eléctrica / Electrical griddles / Plancha électrique

## Serie / Series / Série PE

### A DESTACAR

Resistencias blindadas de acero inoxidable.  
Orificio dispuesto en la placa con cajón recogedor de grasas integrado en el frontal.  
Termostatos con conmutador incorporado con variación de temperatura entre 50°C y 300°C.  
Pies regulables en altura.

### BENEFITS

Heater elements plated in stainless steel.  
Intergrated fat collection drawer in the front.  
Thermostat with variation of teempearture from 50°C to 300°C.  
Adjustable feet.

### À SOULIGNER

Résistances blindées en acier inoxydable.  
Tiroir récupérateur de graisses installé en partie frontale.  
Thermostats avec commutateur incorporé qui permet une variation entre 50° et 300°C.  
Pieds réglables en hauteur.



MODELO/MODELE/MODÈLE	PE60PV	PE75PV	PE60NS	PE80NS	PE60NC	PE80NC
<b>Precio</b> Price Prix						
<b>Medidas</b> EXT. ↔ Measures Mesures INT. ↓	610 435 190	760 435 190	600 435 180	800 435 180	600 435 180	800 435 180
<b>Material</b> Material Matériel	Placa acero pavonado 6mm, negro Treated stainless steel plate 6 mm, black Chrome plate 15 mm, welded splashback		Placa acero laminado 15mm, peto perimetral inox Laminated steel plate 15 mm, welded splashback Chrome plate 15 mm, welded splashback		Placa en cromo duro 15mm, peto perimetral inox Chrome plate 15 mm, welded splashback Chrome plate 15 mm, welded splashback	
<b>Nº quemadores</b> Nº of burners Nº brûleurs	2	2	2	3	2	3
<b>Nº válvulas</b> Nº of valves Nº valves	2	2	2	3	2	3
<b>Superficie útil</b> Usable area Surface utile	590x390	740x390	595x430	795x430	595x430	795x430
<b>Potencia</b> Power Puissance	[W] 4000	4000	4000	5300	4000	5300
<b>Opcional</b> Optional Options	-					



# Grill eléctrico / Electrical grill / Grille panini électrique

Serie / Series / Série **GR**

## A DESTACAR

Todas las placas superiores son acanaladas, excepto los modelos "TL" que son lisas.  
Termostato independiente regulable hasta 250°C.  
Termostato de seguridad.  
Señalizador luminoso, que se apaga cuando la placa ha alcanzado la temperatura deseada.  
Recogedor grasas frontal.

## BENEFITS

All superior plates are grooved, except the models "TL" who are smooth.  
Adjustable thermostat at 250°C.  
Safety thermostat.  
Pilot light which turns off when reaching the desired temperature.  
Frontal greases collector.

## À SOULIGNER

Toutes les plaques supérieures sont rainurées, sauf les modèles "TL" qui sont lisses.  
Thermostat indépendant réglable jusqu'à 250°C.  
Thermostat de sécurité.  
Signal lumineux, qui s'éteint quand la plaque a atteint la température souhaitée.  
Tiroir récupérateur de graisses en position frontale.

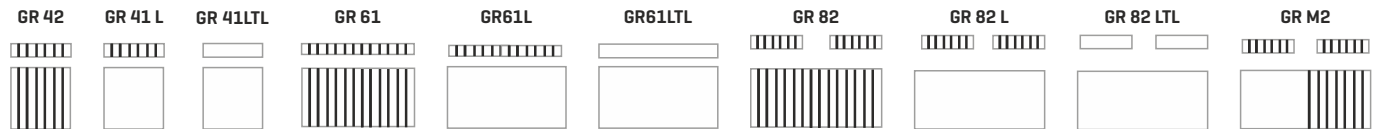

GR 42



GR 82

MODELO/MODELE/MODÈLE	GR 42	GR 41 L	GR 41 LTL	GR61	GR61L	GR61LTL	GR82	GR82L	GR82LTL	GRM2
<b>Precio</b> Price Prix										
<b>Medidas</b> Measures (mm) Mesures	↔ 400 ↕ 430 ↕ 240	↔ 400 ↕ 430 ↕ 240	↔ 400 ↕ 430 ↕ 240	↔ 510 ↕ 430 ↕ 240	↔ 510 ↕ 430 ↕ 240	↔ 510 ↕ 430 ↕ 240	↔ 690 ↕ 430 ↕ 240	↔ 690 ↕ 430 ↕ 240	↔ 690 ↕ 430 ↕ 240	↔ 690 ↕ 430 ↕ 240
<b>Tensión/Frecuencia</b> Power supply [V/Hz] Tension/Fréquence	230/50-60									
<b>Superf. placa inferior</b> Surface low plate Surface plaque inférieur	255 x 245			365 x 245			550 x 245			
<b>Temperatura</b> Temperature [°C] Température	<b>+30°C / +250°C</b>									
<b>Material</b> Material Matériel	Estructura en acero inoxidable / Placas acanaladas o lisas de hierro fundido Stainless steel body / Flat or grooved iron plates Structure en acier inoxydable / Plaques rainurées ou lisses en fonte									
<b>Potencia</b> Power Puissance (W)	1800	1800	1800	3000	3000	3000	3600	3600	3600	3600
<b>Opcional</b> Optional Options	-									

# Freidora eléctrica / Electrical fryer / Friteuse électrique

# Serie / Series / Série FR

## A DESTACAR

Resistencias blindadas de acero inoxidable.  
Cabezal desmontable para facilitar la limpieza de la cuba.  
En los modelos con grifo, cubeta con fondo inclinado para su perfecto vaciado.  
Grifo de media pulgada de paso total.  
Termostato regulable hasta 195°C.  
Termostato de seguridad en todos los modelos.

## BENEFITS

Heater covered by stainless steel.  
Lift out control panel for easy cleaning.  
Models with tap are equipped with slanting tank for easy empty.  
Tap 1/2".  
Adjustable thermostat at 195°C.  
Safety thermostat in all models.

## À SOULIGNER

Résistances blindées en acier inoxydable.  
Tête détachable pour un nettoyage facile du réservoir.  
Pour les modèles avec robinet, cuve à fond incliné pour une vidange parfaite.  
Robinet d'un demi pouce de passage total.  
Thermostat réglable jusqu'à 195 ° C.  
Thermostat de sécurité sur tous les modèles.



MODELO/MODELE/MODÈLE	FR 6L	FR 66L	FR 8L G	FR 88L G	FR 10L G	FR 1010L G	FR 10L GT	FR 1010L GT
<b>Precio</b> Price Prix								
<b>Medidas</b> Measures (mm) Mesures	260 355 320	520 355 320	260 395 315	520 395 315	260 445 315	520 445 315	260 445 315	520 445 315
<b>Tensión/Frecuencia</b> Power supply (V/Hz) Tension/Fréquence	230/50						400+N/50	
<b>Material</b> Material Matériel	Estructura en acero inoxidable Stainless steel body Structure en acier inoxydable							
<b>Capacidad (Aceite)</b> Capacity (Oil) Capacité (Huile)	6	6+6	8	8+8	10	10+10	10	10+10
<b>Grifo</b> Tap Robinet	No / No / Non			Sí / Yes / Oui				
<b>Cesta</b> Basket Panier	210x210x100	210x210x100	220x240x100	220x240x100	220x280x100	220x280x100	220x280x100	220x280x100
<b>Nº cestas</b> Nº baskets Nº paniers	1	2	1	2	1	2	1	2
<b>Potencia</b> Power Puissance	3000	3000x2	3500	3500x2	4500	4500x2	6000	6000x2



# Salamandra / Salamander / Salamandre

## A DESTACAR

Las salamandras completan con eficacia y en poco espacio el equipamiento de cualquier cocina, desde el snack bar hasta la restauración colectiva, tanto con menús de carne como de pescado. Resultan indispensables en locales pequeños que sirven tapas o pinchos, como bares con almuerzos ligeros, mesas calientes, comida rápida y bocaterías, así como en las cocinas de los chefs más exigentes, que cuidan cada detalle de sus platos y preparados.



**Gratinar verduras, patatas y hortalizas. Ultime platos al horno como lasañas, canelones y pasteles salados... Mantener calientes platos listos para servir.**



Grillate vegetables, potatoes and vegetables. Finishing baked dishes such as lasagne, cannelloni and savoury pies... Keeping ready-to-serve dishes warm.



Gratiner des légumes, des pommes de terre. Finir des plats au four tels que lasagnes, cannellonis, flans, quiches... Maintenir à température des plats prêts à servir à table.



**Gratinar pescados, moluscos y crustáceos. Asar a la parrilla o acabar de hacer carnes: hamburguesas, bistecs, salchichas y milanesas... Caramelizar y ultimar postres.**



Grillating fish, molluscs and crustaceans. Grilling or finishing meats: hamburgers, steaks, sausages and breaded meats... Caramelising and finishing desserts.



Gratiner le poisson, les mollusques, les crustacés. Griller ou finir la viande: hamburger, steaks, wurstel, côtelettes... Caraméliser et finir les desserts.

## BENEFITS

Salamanders are an efficient and space-saving addition to any kitchen, from snack bars to catering establishments, for both meat and fish menus. They are indispensable in small establishments serving tapas or pinchos, such as light lunch bars, hot tables, fast food and snack bars, as well as in the kitchens of the most demanding chefs, who take care of every detail of their dishes and preparations.

## Á SOULIGNER

Les salamandres complètent de manière efficace et peu encombrante toutes les cuisines, des snack-bars aux établissements de restauration, pour les menus de viande et de poisson. Elles sont indispensables dans les petits locaux servant des tapas ou des pinchos, tels que les bars à repas légers, les tables chaudes, les fast-foods et les snack-bars, ainsi que dans les cuisines des chefs les plus exigeants, qui soignent chaque détail de leurs plats et de leurs préparations.



BASIC



CLÁSICA / CLASSIC / CLASIQUE



	BASIC			CLÁSICA / CLASSIC / CLASIQUE			
MODELO/MODELE/MODÈLE	SE 40 BM	SE 60 BM	SE 60 BT	SE 40 M	SE 60 M	SE 60 T	SE 80 T
<b>Precio</b> Price Prix							
<b>Medidas</b> Measures (mm) Mesures	↔ 400 ↗ 450 ↕ 500	600 450 500	600 450 500	400 548 500	600 548 500	600 548 500	800 548 500
<b>Tensión/Frecuencia</b> Power supply [V/Hz] Tension/Fréquence	220-240/50-60HZ	220-240/50-60HZ	400 2N/50-60HZ	220-240/ 50-60HZ	220-240/ 50-60HZ	380-415 3N / 50-60HZ	400 3N / 50-60HZ
<b>Potencia</b> Power Puissance	2	4	4	2	4	4	6

Serie / Series / Série **SALAMANDRA**

+Info: [www.infrico.com](http://www.infrico.com)



**ULTRA-RÁPIDA /  
ULTRARAPID /  
ULTRA-RAPIDE**

**Resistencias infrarrojas.**  
20" para alcanzar la temperatura máxima, 5" estando en funcionamiento.  
Excelente uniformidad de cocción.  
2 zonas de cocción independientes (mod. 60), y seleccionables completas o individuales.

**Infrared heaters.**  
20" to reach maximum temperature, 5" in operation.  
Excellent cooking uniformity.  
2 independent cooking zones (mod. 60), selectable full or individual.

**Résistances à infrarouges.**  
20" pour atteindre la température maximale à partir de la mise en marche, 5" en cours de fonctionnement.  
Parfaite uniformité de cuisson.  
2 zones de cuisson indépendantes (mod. 60), sélectionnables comme complètes ou individuelles.



**NEW**

**ULTRA-RÁPIDA CONTACT /  
ULTRARAPID CONTACT /  
ULTRA-RAPIDE CONTACT**



**Función de contacto: barra de detección de placa.**  
Contact function: plate detection bar.  
Fonction de contact : barre de détection des plaques.



**GAS /  
GAS /  
GAZ**



**ULTRA-RÁPIDA /  
ULTRARAPID /  
ULTRA-RAPIDE**

**NEW**

**ULTRA-RÁPIDA CONTACT /  
ULTRARAPID CONTACT /  
ULTRA-RAPIDE CONTACT**

**GAS /  
GAS /  
GAZ**

MODELO/MODELE/MODÈLE	SEUF 40 M	SEUF 60 M	SEUF 60 T	SEUF 40 M	SEUF 60 M	SEUF 60 T	SG 4
<b>Precio</b> Price Prix							
<b>Medidas</b> Measures (mm) Mesures	↔ 400 ↗ 548 ↘ 500	600 548 500	600 548 500	400 548 500	600 548 500	600 548 500	750 400 460
<b>Tensión/Frecuencia</b> Power supply [V/Hz] Tension/Fréquence	220-240/50-60HZ		380-415 3N / 50-60HZ	220-240/50-60HZ		380-415 3N / 50-60HZ	
<b>Potencia</b> Power Puissance	[KW] 2	4	4	2	4	4	7,4



# Tostador de túnel eléctrico / Electric tunnel toaster / Toaster à tunnel électrique

Serie / Series / Série **TTV/TTH**

## A DESTACAR

Modelo TTH3000, apto para tostar, gratinar o calentar.  
Modelo TTV2400 y TTV4000, apto para tostar.  
Resistencias blindadas.  
Selector cuatro posiciones.  
Regulador velocidad cinta.  
Cajón recogemigas.

## BENEFITS

Model TTH3000 for toasting, browning and heating.  
Model TTV2400 and TTV4000 for toasting.  
Recovered heater elements on model.  
Selector four positions.  
Adjustable speed of the band.  
Crumbs drawer.

## À SOULIGNER

Modèle TTH3000, adapté pour griller, gratiner ou réchauffer.  
Modèle TTV2400 et TTV4000, adapté pour grätiner.  
Résistances blindées.  
Sélecteur quatre positions.  
Régulateur vitesse de tapis.  
Tiroir ramasse-miettes.



MODELO/MODELE/MODÈLE	TTV2400	TTH3000	TTV4000
<b>Precio</b> Price Prix			
<b>Medidas</b> Measures [mm] Mesures	480 510 410	750 420 250	570 620 400
<b>Tensión/Frecuencia</b> Power supply [V/Hz] Tension/Fréquence	230/50-60		400/ 230/50-60
<b>Material</b> Material Matériel	Estructura en acero inoxidable Stainless steel body Structure en acier inoxydable		
<b>Nº resistencias</b> Nº heater elements Nº brûleurs	2	2	2
<b>Ancho de cinta</b> Wide of band Largueur du tapis	260	200	360
<b>Altura entrada alimentos</b> Height of opening Hauteur entrée des aliments	70	70	70
<b>Potencia</b> Power Puissance [W]	1400+1400	1500+1500	2000+2000
<b>Opcional</b> Optional Options	-		



# Tostador eléctrico / Electrical toaster / Toaster électrique

## Serie / Series / Série T

### A DESTACAR

**E:** Temporizador regulable 15 minutos, en los modelos T6ECT y T12ECT.

Los modelos sin temporizador T6EST y T12EST, cuentan con interruptores independientes para cada nivel de resistencias.

Dos resistencias por planta, protegidas por tubo de cuarzo de material atóxico.

Cajón recogemigas.

#### T6/T12:

Temporizador regulable 15 minutos.

Interruptores independientes para cada nivel de resistencias.

Tres resistencias por planta, protegidas por tubo de cuarzo de material atóxico.

Cajón recogemigas.

### BENEFITS

**E:** Adjustable time setting up to 15 minutes, the model T6ECT y T12ECT.

Models without time setting T6EST and T12EST, have independant switches for each heater zone.

Two heater elements for each zone, quartz recovered.

Crumbs drawer.

#### T6/T12:

Adjustable time setting up to 15 minutes.

Independant switches for each heater zone.

Three heater elements for each zone, quartz recovered.

Crumbs drawer.

### À SOULIGNER

**E:** Temporisateur réglable 15 minutes. Deux résistances par niveau, protégées par un tube en quartz non toxique. Tiroir ramasse-miettes.

#### T6/T12:

Les modèles sans temporisateur ont des interrupteurs indépendants pour chaque niveau de résistances.

Deux résistances par niveau, protégées par un tube en quartz non toxique.

Tiroir ramasse-miettes.



T6E CT



T6



T12

MODELO/MODELE/MODELE	T6E ST	T12E ST	T6E CT	T12E CT	T6	T12
<b>Precio</b> Price Prix						
<b>Medidas</b> Measures [mm] Mesures	480 260 240	480 260 370	480 260 240	480 260 370	525 305 325	525 305 445
<b>Tensión/Frecuencia</b> Power supply [V/Hz] Tension/Fréquence	230/50				230/50-60	
<b>Material</b> Material Matériel	Estructura en acero inoxidable Stainless steel body Structure en acier inoxydable					
<b>Nº resistencias</b> Nº heater elements Nº resistance	4	6	4	6	6	9
<b>Temporizador</b> Timer Temporisateur	No / No / Non			Sí / Yes / Oui		
<b>Nº interruptores</b> Nº switches Nº d'interrupteurs	2	3	0	1	2	3
<b>Potencia</b> Power Puissance [W]	2000	3000	2000	3000	2000	2750
<b>Opcional</b> Optional Options	-					



**Termo de leche /  
Milk urns /  
Termo de lait**

**Serie / Series / Série TL**

**A DESTACAR**

Calentador al baño María, ideal para leche, café, consomé, té, etc.  
Deposito en acero inox desmontable mediante rosca.  
Termostato autorregulable.  
Interruptor luminoso puesta en marcha.  
Grifo regulable en dos posiciones.

**BENEFITS**

Bain Marie heating, ideal for milk, coffee, consomme, tea, etc.  
Deposit in detachable steel inox by means of spiral.  
Self-regulatory thermostat.  
Beginning luminous switch.  
Adjustable faucet in two positions.

**À SOULIGNER**

Mise en température par bain-marie, idéal pour lait, café, consommé, thé, etc.  
Réservoir en acier inox démontable (système à vissees).  
Thermostat autoréglable.  
Interrupteur lumineux mise en marche.  
Robinet réglable dans deux positions.



TL 6



TL 66

MODELO/MODELE/MODÈLE	TL 3	TL 6	TL 66
<b>Precio</b> Price Prix			
<b>Medidas</b> Measures [mm] Mesures	↔ 232 ↗ 232 ↘ 430	265 265 525	525 265 525
<b>Tensión/Frecuencia</b> Power supply [V/Hz] Tension/Fréquence	220-230/50		
<b>Material</b> Material Matériel	Int/Ext: acero inoxidable AISI 304 Int/Ext: Stainless steel AISI 304 Int/Ext: acier inoxydable AISI 304		
<b>Capacidad</b> Capacity Capacité	[L] 3	6	6+6
<b>Potencia</b> Power Puissance	[W] 1000	1500	1500 +1500
<b>Opcional</b> Optional Options	<b>Sujeción tapa para uso como termo de chocolate.</b> Attachment covers for use like chocolate thermus. Fixation du couvercle pour utilisation comme thermos à chocolat.		

# Cortadora de fiambre / Sharpening slicers / Trancheuse professionnelle

# Serie / Series / Série **CS / CSCEV**

## A DESTACAR

Avance del producto por gravedad.  
Motor ventilado profesional de transmisión por correa.  
Cuchilla rectificada y cromada en cromo duro.  
Espesor máximo de corte 14 - 16 mm.  
Afilador fijo en la gama "S".  
Interruptor marcha-paro con relé, que no permite, en caso de interrupción de la corriente, el funcionamiento de la máquina sin el rearme del mismo [GAMA SCEV].  
Fácil limpieza de todos sus componentes.

## BENEFITS

Professional ventilated motor.  
Tempered ground hard chromium-plate professional blade.  
Slizing thickness up to 14 - 16 mm.  
Fixed sharpener in range "S".  
Start and stop switch with relay to avoid the automatic restarting of the machine in the case of electrical power shortage [RANGE SCEV].  
Easy cleaning of all components.

## À SOULIGNER

Avancée du produit par gravité.  
Moteur ventilé professionnel avec transmission par courroie.  
Lame concave.  
Épaisseur maximale de coupe 14 - 17 mm.  
Rémouleur fixe dans la gamme "S".  
Interrupteur marche-arrêt avec un relais qui ne permet pas, en cas de coupure de courant, le fonctionnement de la machine sans reprogrammation [SCEV].  
Nettoyage facile de tous ses composants.



C220 SCEV



C250 S



C300 SCEV



C 350 SCEV

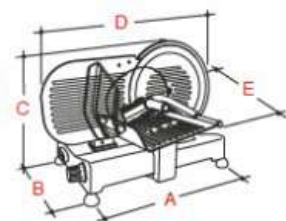

**Afilador con doble esmeril.**  
Sharpener with double emery  
Rémouleur avec double émeri.



**Modelo SCEV con bloqueo de carro deslizante que permite desmontar la bandeja de alimentos y su cojinete.**

Model SCEV with block of sliding carriage which allows to disassemble the food tray and its bearing  
Modèle SCEV avec verrouillage du chariot coulissant qui permet de démonter le plateau à aliments et son roulement.



**Prensa producto con protección en plexiglas**

Food-holder arm with protection in plexiglass

Presse avec protection en plexiglas



MODELO/MODELE/MODELE	C 220 S C 220 SCEV	C 250 S C 250 SCEV	C 275 S -	C 300 S C 300 SCEV	- C 350 SCEV
Precio Price Prix					
Dimens. A (mm)	385	385	400	438	487
Dimens. B (mm)	245	245	250	298	355
Dimens. C (mm)	355	365	390	420	515
Dimens. D (mm)	425	475	685	520	685
Dimens. E (mm)	400	410	555	450	555
Tensión/Frecuencia Power supply [V/Hz] Tension/Fréquence	220/50				
Material Material Matériel	Estructura fundición de aluminio anodizado [C275 S aluminio lacado] Structure anodized aluminium [C275 S laquered aluminium] Structure aluminium anodisé [C275 S aluminium laqué]				
Diámetro cuchilla Diameter slicer (mm) Diamètre lame	220	250	275	300	350
Potencia Power Puissance (W)	170	190	150	250	400
Capacidad corte (mm Cutting capacity Épaisseur de tranches ±S)	200 125	195 145	225 180	245 195	280 220

















